

Big
WHITE®

'22

SLV LIGHTING CATALOGUE

UNSER VERSPRECHEN.



SCHNELLE UND ZUVERLÄSSIGE LIEFERUNG
24h (DEUTSCHLAND), 48h (EUROPA)

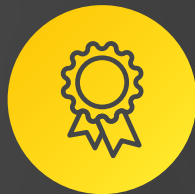

5 JAHRE GARANTIE*



PREIS UND LEISTUNG IN PERFEKTEM EINKLANG



GERMAN ENGINEERING



WIR SIND IHR WARENLAGER
98% VERFÜGBARKEIT

VERTRIEB NATIONAL

Rufnummer:
+49 (0) 2451 4833 - 333

Faxnummer:
+49 (0) 2451 4188 - 8

Mail:
info@slv.de

Montag bis Donnerstag:
08:00 – 17:00 Uhr

Freitag:
08:00 – 14:30 Uhr

TECHNISCHER SERVICE

Rufnummer:
+49 (0) 2451 4833 - 600

Faxnummer:
+49 (0) 2451 4833 - 519

Mail:
service@slv.de

Montag bis Donnerstag:
08:00 – 17:00 Uhr

Freitag:
08:00 – 14:30 Uhr

ZENTRALE

SLV GmbH
Daimlerstraße 21–23
52531 Übach-Palenberg

Rufnummer:
+49 (0) 2451 4833 - 0

Montag bis Donnerstag:
08:00 – 17:00 Uhr

Freitag:
08:00 – 14:30 Uhr

slv.com

LOGISTIKCENTER

SLV GmbH
Werkstraße 8–10
52531 Uebach-Palenberg

KUNDENZUFRIEDENHEIT

SLV wird Sie mit exzellentem Kundenservice und Lieferperformance begeistern! Unser engagiertes Team steht Ihnen für jedes Anliegen persönlich zur Verfügung!

Rufen Sie uns an (+49 (0) 2451 4833 - 333), kontaktieren Sie uns per E-Mail (info@slv.de) oder bestellen Sie direkt auf unserer Internetseite slv.com. Wir freuen uns auf Ihr Projekt!

KUNDENINFO

Bitte beachten Sie zudem unsere Rücksenderichtlinien und Reparaturbedingungen, die Sie auf unserer Internetseite slv.com/de/service/downloads finden.

Sofern keine anderweitigen Vereinbarungen bestehen, richten sich alle Lieferungen und Leistungen nach unseren Allgemeinen Geschäftsbedingungen, welche Sie auf unserer Internetseite slv.com/de/agb einsehen können.

SLV ist berechtigt, die jeweilige Preisliste an sich verändernde Marktbedingungen, bei erheblichen Veränderungen in den Beschaffungskosten, Änderungen der Umsatzsteuer oder der Beschaffungspreise, anzupassen.

*Bitte beachten Sie die Garantiebedingungen unter slv.com → Service → Downloads → Garantiebedingungen.

BIG WHITE®

Gedruckt oder digital – bei uns haben Sie die Wahl.

SLV.COM – LICHT ONLINE ERLEBEN

Auf unserer Online-Plattform finden Sie das komplette SLV Sortiment mit allen Produktdaten, Beschreibungen, Verfügbarkeiten und mehr. Ein Filter macht die Suche einfach möglich. Nützliche Planungsdateien, 3D-Daten, Konfiguratoren und Kalkulationstools wie FastCalc by DIAL unterstützen Sie bei Ihrer Lichtplanung. Immer am Puls der Zeit, mit zahlreichen News aus der Welt des Lichts. Besuchen Sie slv.com



DER DIGITALE BIG WHITE® – IHR FLEXIBLER BEGLEITER



Mit unserem digitalen Blätterkatalog haben Sie ein Werkzeug an der Hand, das Ihren Kundenbesuch effizienter denn je macht: Sie bringen nicht nur ein digitales Abbild unseres Hauptkatalogs mit, sondern erhalten durch weitere Services einen schnellen Einblick in genau die Produkte von SLV, die Sie sehen wollen.

SLV EXPERIENCE LIGHT APP: AUCH VIRTUELL ECHE TE INSPIRATION ERLEBEN.

Schon vorher wissen, wie SLV Leuchten beim Kunden wirken.

Mit unserer Augmented Reality App SLV EXPERIENCE LIGHT finden Sie immer die perfekte Leuchte – direkt vor Ort, drinnen oder draußen. Dank der einfachen Bedienung ist sie gerade für Elektroinstallateure und Lichtplaner ein wichtiges Beratungsinstrument. Denn wo die Vorstellungskraft des Kunden aufhört, fangen die Möglichkeiten der App erst an: Präsentieren Sie virtuell, wie unsere Leuchten am zukünftigen Einsatzort wirken.



SLV EXPERIENCE LIGHT

App gratis downloaden.

Laden Sie sich die kostenlose Augmented Reality App gleich im Apple App Store oder im Google Play Store auf Ihr Smartphone oder Tablet.



SLV – LICHT NOCH BESSER ERLEBEN.

Licht erhellt, inszeniert und beeinflusst uns in allen Bereichen. Weil dabei Digitalisierung, Nachhaltigkeit und Qualität mehr denn je im Fokus stehen, entfaltet auch SLV seine Strahlkraft immer wieder neu.

EXPERIENCE LIGHT.

Das Ziel von SLV ist es, Licht in allen Facetten erlebbar zu machen: Mit fortschrittlichen, ressourcenschonenden und hochwertigen Produkten. Erstklassiger Service, eine hohe Liefertreue und einfache Installierbarkeit sorgen für deutlich weniger Zeit-, Kosten- und Arbeitsaufwand.





NACHHALTIG VERTRAUEN.

SLV entwickelt seine Leuchten in Deutschland und schafft durch eine konsequente Qualitätssicherung die Basis für Ihre Zufriedenheit. Dazu kommt der starke Fokus auf Nachhaltigkeit, die wir ganzheitlich über alle Kernprozesse hinweg betrachten.



HOCHWERTIG GEPRÜFT.

Mit seinem German Engineering-Ansatz entwickelt SLV Leuchten und schafft durch konsequente Qualitätssicherung die Basis für Ihre Zufriedenheit. SLV Leuchten werden auf Herz und Nieren in eigenen Laboren getestet, die am deutschen SLV Hauptsitz in Übach-Palenberg (Nordrhein-Westfalen) und im asiatischen Shanghai angesiedelt sind. So liefern wir nicht nur Qualität, sondern garantieren sie auch: 5 Jahre lang. Dabei wird ein starker Fokus auf Nachhaltigkeit gelegt, ganzheitlich und über alle Kernprozesse hinweg. Sie sehen: Auf die Marke SLV ist Verlass.



ZUKUNFTSSICHERE BELEUCHTUNG.

Produkte weiterzuentwickeln und neue Lösungen zu erarbeiten ist das, was uns bei SLV antreibt. Ob digitale Technologien oder neue Standards zu setzen, Geräte intelligent zu vernetzen oder Systemlösungen anzubieten: SLV steht für moderne und zukunftsichere Beleuchtung.



ZUVERLÄSSIGE LIEFERUNG.

Mit einer konstanten Warenverfügbarkeit von 98 % können wir alle Kunden zuverlässig und schnell aus unserem deutschen Logistikzentrum beliefern.



DURCH ERFOLG VERBUNDEN.

Erfolg ist auch immer das Ergebnis einer engen Zusammenarbeit – mit Ihnen als Kunden und mit starken Partnern, auf die sich SLV innerhalb und außerhalb der Lichtbranche verlassen kann.

GUT FÜR DIE UMWELT. GUT FÜR SIE.

Jeden Tag verfolgen wir unser Ziel, nachhaltige Ergebnisse über die gesamte Wertschöpfungskette zu erzielen. Mit unterschiedlichen Maßnahmen in den Bereichen Produktion, Verpackung, Logistik und darüber hinaus.

DIE ZUKUNFT IST JETZT.

Das Vermeiden, Vermindern, Wiederverwenden und Recyceln steht bei SLV im Mittelpunkt: Wir gestalten Produkte und Verpackungen umweltgerecht, reduzieren versteckte Abfälle, verringern Emissionen und optimieren Logistikprozesse. Heute schon setzen wir bei der Entwicklung der Lichttechnik konsequent auf Nachhaltigkeit.

NACHHALTIGE VERPACKUNGSLÖSUNGEN.

Dank Verpackungslösungen nach Anfrage (On Demand Packaging) sparen wir Zeit, Verpackungsmaterial und Kosten ein. Indem wir maßgeschneiderte Kartons von Packsize NOW verwenden, können wir die Menge an Wellpappe und Füllmaterial deutlich reduzieren. Durch das geringere Transportvolumen entstehen auch weniger CO₂-Emissionen beim Versand. Dazu setzen wir auf recyceltes Material, beschränken uns auf zwei Druckfarben und versuchen, Klebstoffe und glänzende Lacke so gut wie möglich zu vermeiden.

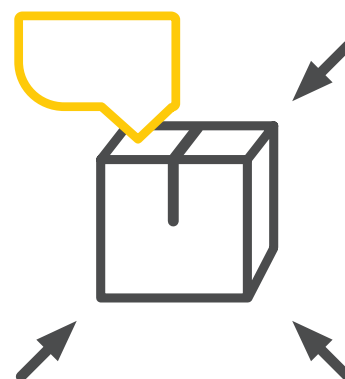

GROSSER KATALOG MIT KLEINEM CO₂-FUSSABDRUCK

Neben unserer klassischen Kataloggröße DIN A4 bieten wir den BIG WHITE® sowohl im handlichen DIN A5 Format als auch digital an. Damit schonen wir nicht nur wertvolle Ressourcen, wir verringern außerdem CO₂-Emissionen und sparen Kosten ein. Unser gedruckter BIG WHITE® ist FSC-Mix-zertifiziert – neben 100 % recyceltem Papier findet dabei nur Papier Verwendung, bei dem das Holz überwiegend aus nachhaltig bewirtschafteten Wäldern stammt. So machen wir unsere Katalogproduktion nachhaltig und umweltfreundlich.





PRODUKTE MIT RECYCELTEN SEKUNDÄRROHSTOFFEN.

Um Ressourcen zu schonen, ersetzen wir sukzessive und wann immer technisch möglich Primärrohstoffe durch Sekundärrohstoffe. So besteht beispielsweise unsere Erdspießleuchte SAMRINA zum Teil aus einem Kunststoff, der bis zu 35 % recycelte Rohstoffe enthält. In der Leuchten-Gesamtmasse macht der Anteil des recycelten Materials ganze 17 % aus. Gleichzeitig überzeugt SAMRINA mit der von SLV gewohnten Qualität und Langlebigkeit. Um die Umwelt zu schonen, legen wir Wert darauf, dass alle unsere Produkte am Ende ihrer Lebenszeit leicht zu recyceln sind.

1004757 592

NEUE ENERGIE-EFFIZIENZKLASSEN.

Seit September 2021 gelten neue Regeln zur umweltgerechten Gestaltung (Ökodesign) und zur Energieverbrauchskennzeichnung (Produktinformation) von energierelevanten Produkten. Sie betreffen Lichtquellen, wie z. B. LED-Module oder Lampen mit Sockel.

KEINE NEUEN LABEL FÜR LEUCHTEN.

Die Umsetzung der neuen Regelungen für Beleuchtung regeln die EU-Verordnungen 2019/2015 bzw. 2021/340 (Produktinformation) und 2019/2020 bzw. 2021/341 (Produktdesign), welche die bisherigen Vorgaben ersetzen und ergänzen. Davon betroffen sind Lichtquellen wie Lampen mit Sockel und LED-Module. Leuchten mit eingebauten zerstörungsfrei entnehmbaren Lichtquellen gelten hingegen als umgebende Produkte und erhalten kein eigenes Energielabel – jedoch muss die Energieklasse der eingebauten Lichtquelle in der Anleitung angegeben sein.

ZUKUNFTSFÄHIGE SKALA.

Die neue EU-Verordnung sieht eine Neuskalierung der Energieklassen vor. Dabei reicht die künftige Energielabel-Skala von A bis G und steht nicht im Zusammenhang mit der bisherigen Skala. Damit die Einteilung zukunftsfähig bleibt, hat der Gesetzgeber die Anforderungen so gestaltet, dass die höheren Klassen erst in Zukunft erreicht werden können. Das bedeutet, um ein Beispiel zu nennen, dass auch eine Lichtquelle mit einer Energieklasse E eine gute Effizienz aufweist.

NEUE ENERGIEETIKETTEN.

Das Design der Energieetiketten hat sich ebenfalls verändert. Damit ein Energieetikett in allen Mitgliedstaaten der EU verwendet werden kann, wurden die sprachlichen Bestandteile entfernt. Auf dem Etikett ist zudem ein QR-Code abgebildet, der auf den entsprechenden Eintrag eines Produkts im öffentlich zugänglichen Teil der europäischen Produktdatenbank für die Energieverbrauchskennzeichnung (EPREL-Datenbank) verweist.

DER EFFIZIENZ VERPFLICHTET.

SLV stellt als Unternehmen sicher, dass alle Produkte den neuen Verordnungen entsprechen. Dabei gilt für stationäre Händler mit einem noch vor dem 1. September 2021 erworbenen Bestand an betroffenen Produkten eine Übergangsfrist von 18 Monaten, in der die alten Energieetiketten weiterverwendet werden dürfen.

1004772 443





WUSSTEN SIE SCHON?

Wie die neuen Energieeffizienz-
klassen zu verstehen sind.

Unser Beispiel – die SLV One 40 Track:



Das Produkt weist weiterhin eine gute
Effizienz auf, nur die Einordnung ändert sich.
So können die Energieeffizienzklassen
lange gültig bleiben.

Mehr Informationen über die jeweilige Leuchte,
erfahren Sie über den QR-Code auf dem
Energieetikett. – **Einfach scannen!**

NEUE PRODUKT-DARSTELLUNG.

Wir haben unsere Produktdarstellung gründlich überarbeitet – damit Sie Ihre Kunden optimal beraten können. Übersichtlich, detailliert und kundenorientiert.

DER BLICK AUFS WESENTLICHE

Neue Icons und Symbole fassen wichtige technische Details für Sie zusammen.



- LED Technik verbaut
- Lichtstrom
- Farbtemperatur
- Farbwiedergabeindex



- Leuchte mit Lampenfassung
- Leuchtmittel
- maximale Wattage

WISSEN, WO ES LANG GEHT

Alle Angaben werden mit neuen Symbolen gekennzeichnet.



PRODUKTANGABEN

Alle technischen Produktangaben für den Lichtprofi.



LEUCHTMITTELANGABEN

Immer das passende Leuchtmittel finden



LEUCHTMITTELEMPFEHLUNG

Machen Sie Ihre Sockelleuchte komplett und bestellen Sie das passende Leuchtmittel gleich dazu.







ZUBEHÖREMPFEHLUNG

Erweitern Sie die Funktion und ergänzen Sie Ihre Leuchte mit passendem Zubehör.



EEK ANGABE



Die Energieeffizienz aller Lichtquellen und Varianten auf einen Blick.

		
1001309, 1001310	3700lm 3000K	









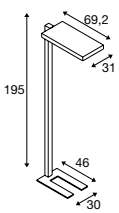

WORKLIGHT
FL



NEW

7600lm
4000K
CRI 80















200-240V ~50/60Hz | 2000mA
Total wattage: 79W
Material: aluminium

- Euro plug



		A → G
Up/Down	3800lm 4000K	A → G

Options	Prod. no.	EUR
Up: 3800lm 4000K CRI80 Down: 3800lm 4000K CRI80	1005390	■

Bessere Lesbarkeit

Unsere „NEW“, „NEW VARIANT“ und „FOLLOWER“ Produkte sind jetzt noch leichter zu erkennen.

Auf einen Blick

Die wichtigsten Informationen für Ihre Kunden zusammengefasst.

Für den Lichtprofi

Technische Details, Zubehör und passende Leuchtmittel.

Neue EEK Angabe

Nachhaltige und sparsame LED Beleuchtung. Auch in Zukunft.



NEW ONE 60



NEW ONE LINEAR



NEW PANEL TRACK



NEW GRAFIT



NUMINOS® 014 - 095

N

Leuchtensystem.....	014 - 027
Downlights.....	028 - 061
Hochvolt-Stromschiene 3-Phasen	062 - 071
Wand- und Deckenleuchten	072 - 073
Deckenleuchten	074 - 087
Pendelleuchten	088 - 095

INDOOR 096 - 507



Tisch- und Standleuchten.....	096 - 113
Pendelleuchten	114 - 179
Wandleuchten.....	180 - 245
Deckenleuchten	246 - 289
Wand- und Deckenleuchten	290 - 341



Einbauleuchten	342 - 423
----------------------	-----------



Hochvolt-Stromschiene 3-Phasen	424 - 459
Hochvolt-Stromschiene 1-Phasen	460 - 485
Hochvolt-Stromschiene Easytec® II.....	486 - 495
Niedervolt-Seilsystem.....	496 - 507

OUTDOOR 508 - 731



Mobile Leuchten und Standleuchten.....	508 - 583
Strahler.....	584 - 603
Wand- und Deckenleuchten	604 - 693



Wandeinbauleuchten.....	694 - 703
Deckeneinbauleuchten	704 - 713
Bodeneinbauleuchten	714 - 731

PROFILLÖSUNGEN 732 - 749



LED-STRIPS 750 - 763



CONNECTED LIGHTING 764 - 787



DALI – Licht professionell vernetzen.....	764 - 777
ZIGBEE® 3.0 – Das smarte Funkprotokoll.....	778 - 787

ZUBEHÖR 788 - 807

A+

LEUCHTMITTEL 808 - 819



LEUCHTENFAMILIEN, INDEX UND REFERENZEN 820 - 866



Die SLV Leuchtenfamilien	820 - 835
Numerisch	838 - 851
Alphabetisch	855 - 859
Referenzen.....	860 - 866

Weitere Leuchten und Varianten finden Sie online unter www.slv.com

Alle Preisangaben verstehen sich als unverbindliche Preisempfehlungen (UVP) ohne MwSt.





NUMINOS® EIN LEUCHTENSYSYSTEM – TAUSEND MÖGLICHKEITEN.

FÜR JEDEN FALL
DIE PASSENDE
LICHTLÖSUNG.



DAS FREI KONFIGURIERBARE LEUCHTENSYSYSTEM,
DAS JEDES AMBIENTE INS BESTE LICHT RÜCKT.

Kein Projekt ist wie das andere. Aber viele Projekte verlangen ein einheitliches Licht- und Designkonzept. NUMINOS® ist ein perfekt aufeinander abgestimmtes Leuchtensystem, das Funktion, Design und Technik in Einklang bringt. Für Planer und Macher. Für jede Anforderung. Für maximale Vielfalt bei minimalem Aufwand.



NUMINOS®



HOCHLEISTUNGS LED MODUL MIT
BRILLANTER FARBWIEDERGABE



BREITE AUSWAHL AN DOWNLIGHTS
UND SPOTS FÜR EIN HARMONISCHES
DESIGNKONZEPT.

MEHR FREIHEIT MIT SYSTEM.

WAS SIE AUCH VORHABEN – DAS NUMINOS®
LEUCHTENSYSTEM SCHAFFT RAUM FÜR IDEEN.



Das NUMINOS® Leuchtensystem bietet konstante Lichteigenschaften und modernes Design über alle Anwendungen hinweg:

- für Büroräume
- Shops & Boutiquen
- Hotellerie & Gastronomie
- Zuhause
- und vieles mehr

Vom Hotel übers Büro bis hin zu gewerblichen oder privaten Räumen. Von der Anwendung über die Technik bis zum Design im Detail: Gut, dass sich die modularen Down- und Spotlights genauso konfigurieren lassen, wie es die Planung oder Raumbedingungen erfordern. Und je facettenreicher Ihr Projekt ist, desto mehr profitieren Sie vom NUMINOS® Leuchtensystem.

Licht inszenieren,
ohne zu
dominieren.



NUMINOS®
GIMBLE M, DL
Art.-Nr.
1005945
NUMINOS®
Move S, DL
Art.-Nr.
1005340

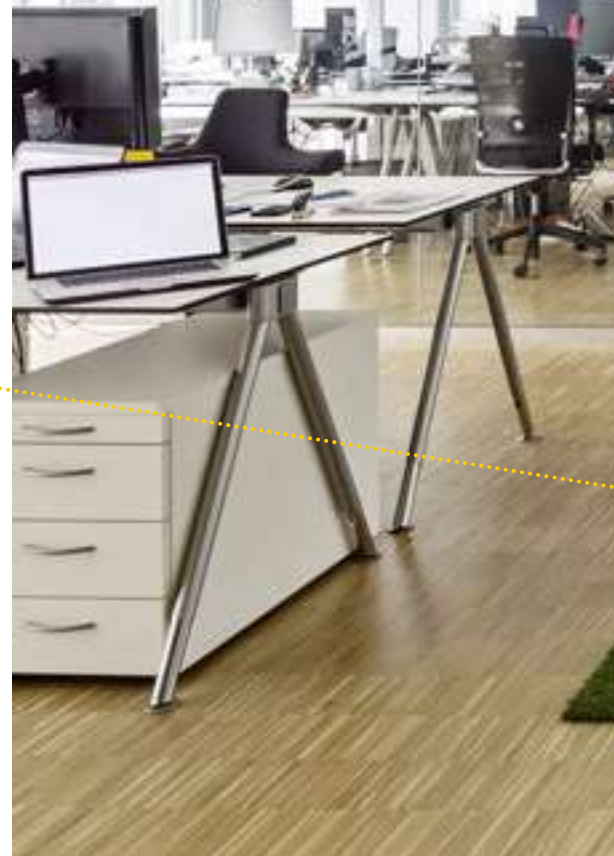

**Highlights,
die nach unten
strahlen.**



NUMINOS® XL, CL
Art.-Nr.
1005767

**Frei für alle
Dimensionen.**



NUMINOS®
Zoom M, 3Ph.
Art.-Nr.
1006116

**Perfekt zum
Pendeln, in der
Höhe variabel.**



NUMINOS® XL, PD
Art.-Nr.
1005783

EINZIGARTIGE VIELFALT, GEMEINSAME HIGHLIGHTS.

Wählen Sie zwischen:

- Downlight oder Spotlight
- Größen und Durchmessern
- Gehäusefarben (Schwarz/Weiß)
- Reflektorvarianten
- Schwenkbaren und starren Versionen
- Leistungsklassen

Die verschiedenen Varianten verfügen über:

- Hochleistungs LED Modul mit den Lichtfarben 2700K/3000K/4000K
- Farbqualität CRI>90
- Blendungsbewertung UGR mind. <22



DOWNLIGHTS

In sieben Varianten (68-75mm bis 176-186mm) mit Hochleistungs LED Modul in drei Lichtfarben (2700K, 3000K, 4000K) und Blendungsbewertungen (UGR 16, 19, 22) erhältlich.

Wählbare Reflektoren mit Halbstreuwinkeln von 20°, 40° oder 55°.

Verschiedene Effektfilter (gefrostet/prismatisch/elliptisch/Wabe) als Zubehör verfügbar.

Dekoring als sichtbarer Abschluss in Weiß, Schwarz oder Chrom wählbar.

NUMINOS® Downlights sind als starre oder schwenkbare Variante (4x fix und 3x dreh- und schwenkbar) erhältlich.



XS S M L XL

Zubehör mit System:

Ihren optionalen Treiber (On/Off, Phasendimmung, DALI) und passende Diffusoren können Sie über die Farbkodierung ganz einfach hinzufügen.

Treiber, Diffusoren und Reduzierringe für das SLV NUMINOS® Downlight System finden Sie auf den Seiten 58-61.

EIN LEUCHTENSYSTEM, DURCHDACHT BIS INS DETAIL.

Dank der breiten Auswahl an Modulen gibt es für jede Anforderung die passende Lösung. Fix konfiguriert. Schnell und sicher installiert.



SPOTLIGHTS

In drei Gehäusegrößen (65x155mm, 85x175mm, 100x203mm) mit Hochleistungs LED Modul in drei Lichtfarben (2700K, 3000K, 4000K) verfügbar.

Durch den verbauten LED-Treiber (Phasendimmung, DALI) sind alle Spotlights für den direkten Anschluss an 230V Netzspannung geeignet.

Wählbare Linsen mit Halbstreuwinkeln von 24°, 36° oder 60°.

NUMINOS® Spotlights sind als schwenkbarer oder starrer Deckenspot, Pendelleuchte und als Spot für 3-Phasen Schienensysteme erhältlich.



Easy to install.

Weil sich Effizienz immer auszahlt, sind SLV Leuchten leicht, schnell und sicher zu installieren. So bietet der Anschluss via Montageplatte, Schienensystem, Schnellkupplung, Federbügel und mit farbkodierten Treibern für Downlights einen entscheidenden Vorteil: Sie sparen Zeit Aufwand und damit auch Kosten.



EIN LEUCHTENSYSTEM. FÜR ALLE FÄLLE.

Für Erfolg unter allen Bedingungen braucht es Teamplayer, die mit individuellen Stärken glänzen. Entdecken Sie, für welche Einsätze sich NUMINOS® Leuchten besonders gut eignen.



Objekte zu einem
Hingucker machen.



NUMINOS®
GIMBLE XS, DL
Art.-Nr.
1005817

Downlights.

Unauffällige, moderne und platzsparende Beleuchtung, die den Fokus auf Objekte oder den Raum lenkt: Die Downlights des NUMINOS® Leuchtensystems sind in in gewerblichen und privaten Räumen variabel einsetzbar.



Für die elegante
Ausleuchtung von
Wohnbereichen.



NUMINOS®
GIMBLE XS, DL
Art.-Nr.
1005843

Für Eingangsbe-
reiche, die Gäste
willkommen heißen.



NUMINOS® XS
DL
Art.-Nr.
1005520



In Fluren den
Weg weisen.



NUMINOS®
MOVE XS, DL
Art.-Nr.
1005584

Um in Verkaufsräumen Akzente zu setzen.



NUMINOS®
GIMBLE M, DL
Art.-Nr.
1005953

Beleuchtung individuell gestalten.

Durch die große Auswahl an Reflektoren eignet sich das NUMINOS® Leuchtensystem für die Akzentbeleuchtung wie auch zur Ausleuchtung von Produkten und Verkaufsflächen.

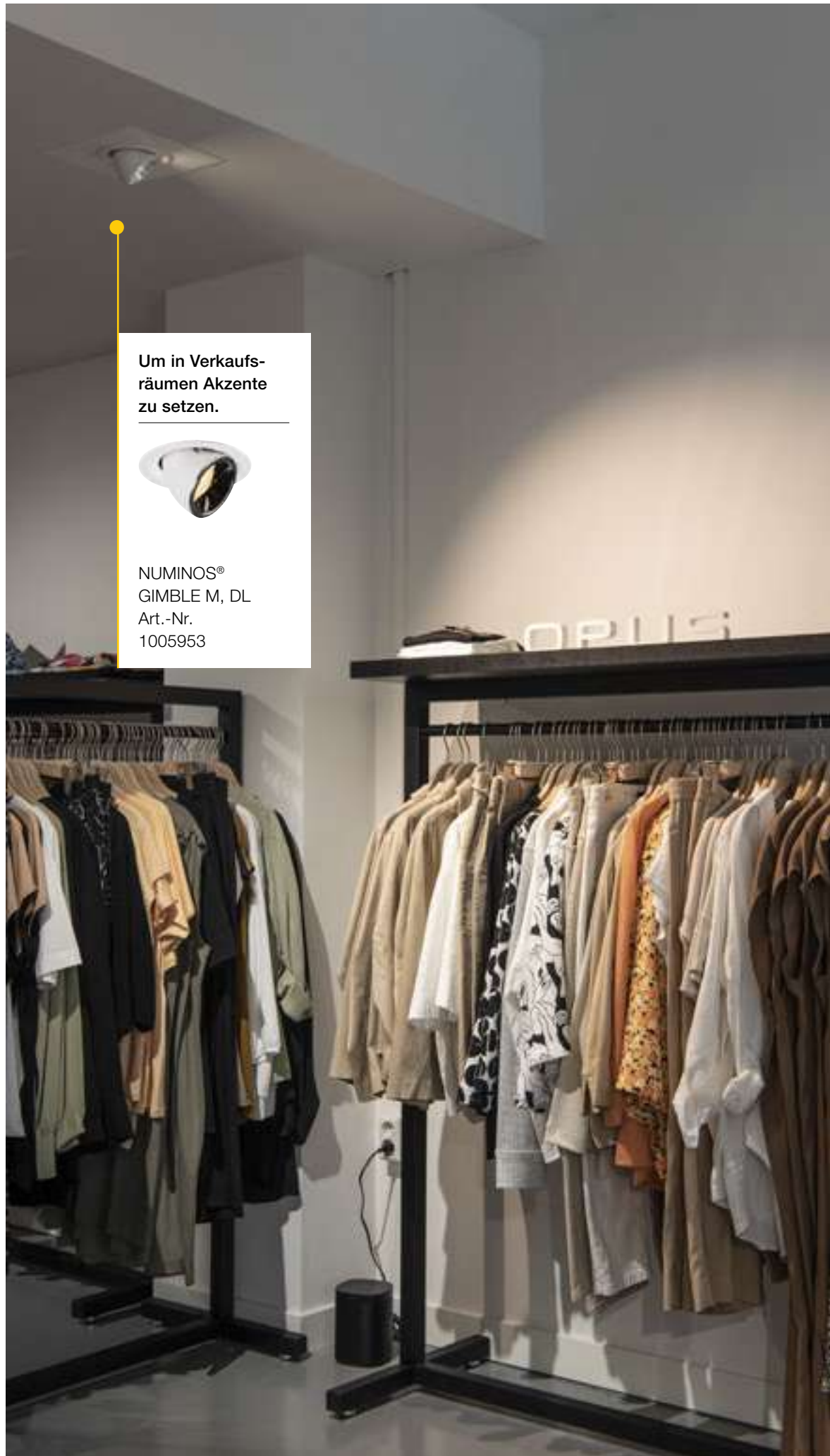

Für die perfekte
Inszenierung von
Objekten.



NUMINOS®
GIMBLE S, DL
Art.-Nr.
1005899

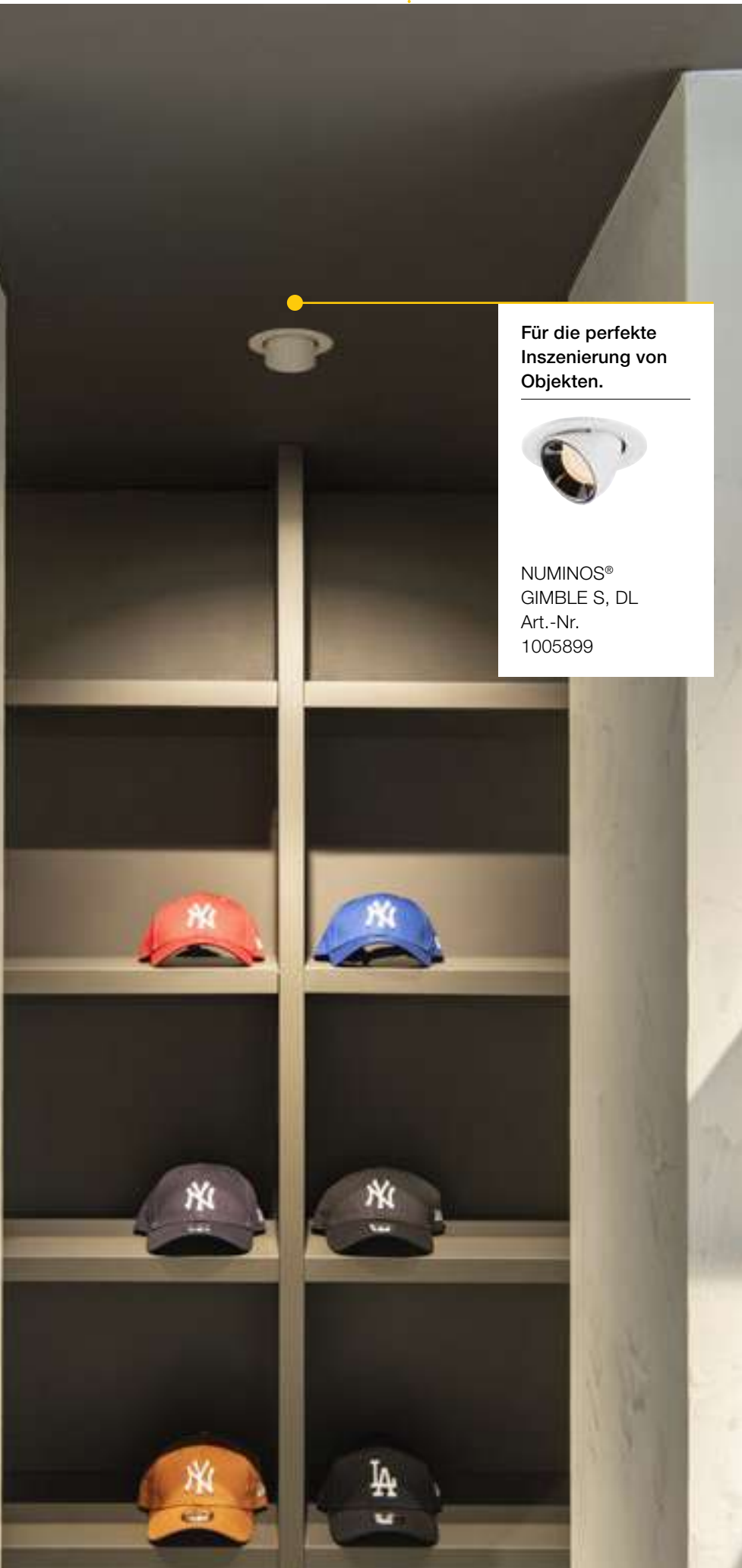

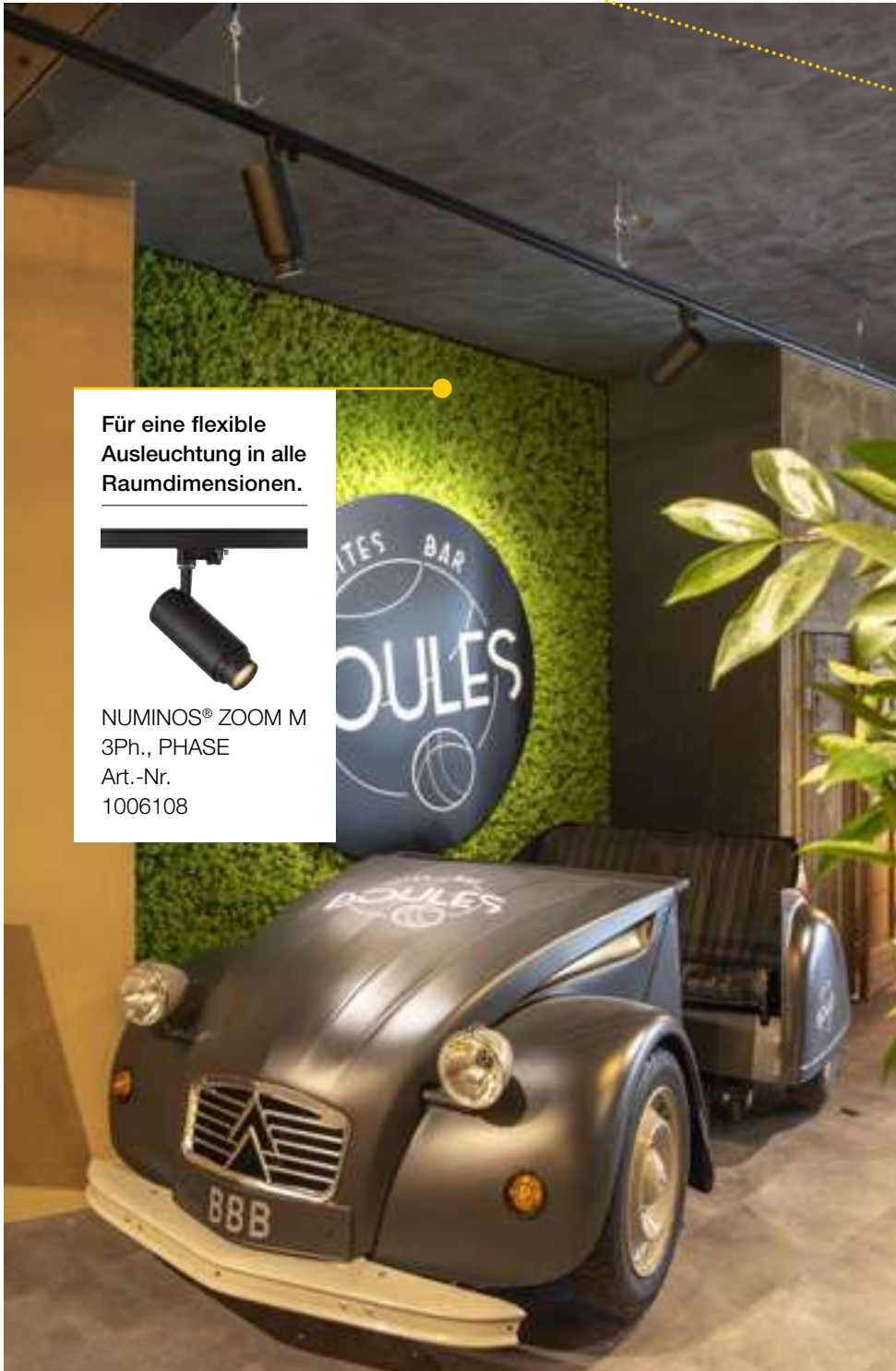

Für eine flexible Ausleuchtung in alle Raumdimensionen.



NUMINOS® ZOOM M
3Ph., PHASE
Art.-Nr.
1006108

Produkte gekonnt in Szene setzen.



NUMINOS® ZOOM M
3Ph., DALI
Art.-Nr.
1006119

Spotlights.

In Shops und Boutiquen, aber auch in Restaurants, Bars, Museen, Studios, Praxen – in jedem Raum kommt es auf gekonnt gesetzte Akzente an. Spotlights sind sowohl für die Ausleuchtung größerer Flächen, als auch für die punktuelle Beleuchtung einsetzbar.





Um ein appetitan-
regendes Ambiente
zu erschaffen.



NUMINOS® M
PD, PHASE
Art.-Nr.
1004247
kombiniert
mit Zierring
Art.-Nr.
1006168

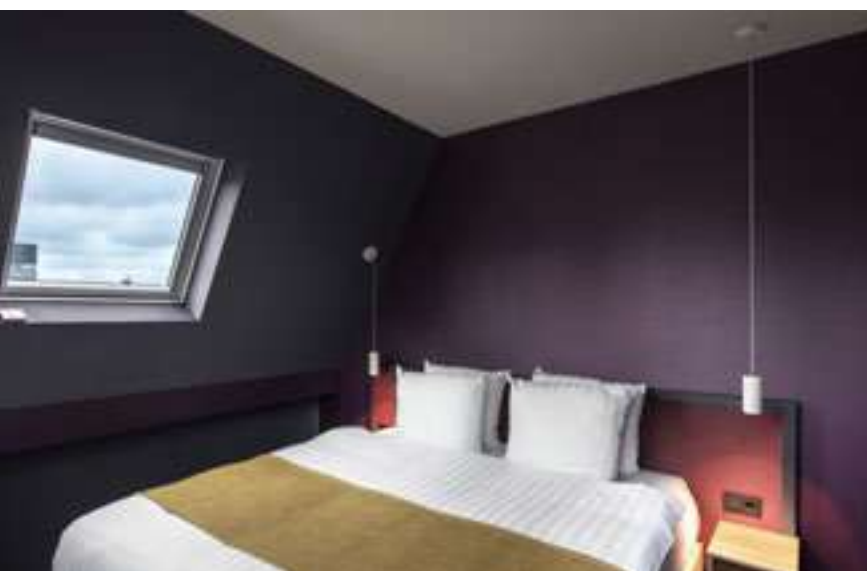

Für mehr
Gemütlichkeit
zu Hause.



NUMINOS® S, PD, DALI
Art.-Nr. 1004439
kombiniert mit Zierring
Art.-Nr. 1006167



SYSTEMATISCH ZUM ZIEL.

Mit dem NUMINOS® Online Konfigurator.

So einfach funktioniert der Konfigurator:

Die erste Frage lautet: Downlight oder Spotlight? Anschließend wählen Sie zwischen vorkonfigurierten und weiter anpassbaren Anwendungsszenarien oder der freien Konfiguration.

Falls Sie bei der Auswahl der Attribute noch unsicher sind, kein Problem: Zu jeder gewählten Konfiguration bieten wir Ihnen passende Erklärungen an.

Hier gelangen Sie zum NUMINOS® Konfigurator:

www.numinos.SLV.com

Nur drei Schritte und Sie sind am Ziel:

- 1 TECHNISCHE KONFIGURATION
↓
- 2 OPTISCHE KONFIGURATION
↓
- 3 VISUELLE DARSTELLUNG & ABSCHLUSS

Hier und jetzt zum Ziel – konfigurieren Sie Ihre Leuchte mit dem BIG WHITE®.

Stellen Sie Ihre Wunschleuchten auf den nächsten Seiten zusammen.

Die folgenden Produktübersichten bringen Sie ebenso leicht zum Ziel: Blättern Sie zum gewünschten Leuchtentyp, folgen Sie den Spalten von links nach rechts und treffen Sie dabei Ihre individuelle Auswahl. Am Ende steht die passende Artikelnummer zur direkten Bestellung bereit.

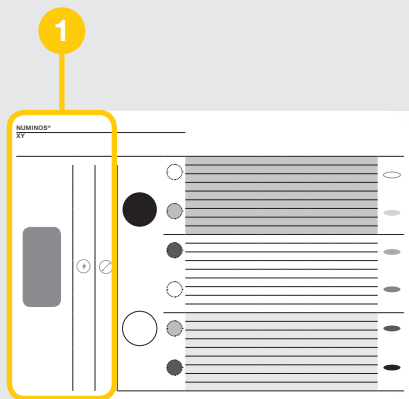

STEP 1

SPOTLIGHT ODER DOWNLIGHT?

Wählen Sie den passenden Leuchtentyp für Ihre Anforderung aus. Der Durchmesser (Downlights) bzw. die Gehäusegröße (Spotlights) sind dabei an die Systemleistung gekoppelt.

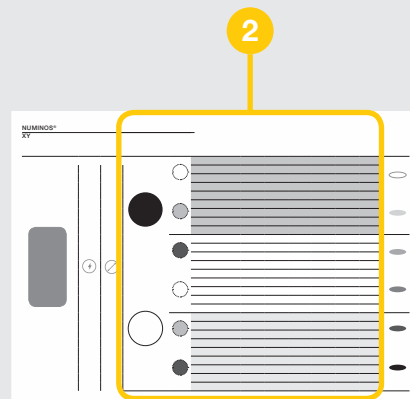

STEP 2

TECHNISCHE KONFIGURATION & DESIGN AUSWÄHLEN

Spalte für Spalte wählen Sie optische und technische Attribute wie Gehäuse- oder Dekorfarben, die Farbtemperatur, Halbstreuwinkel und mehr aus.

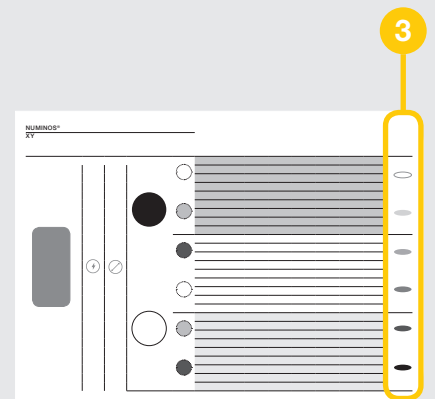

STEP 3

PRODUKT

Verschaffen Sie sich noch einen optischen Eindruck Ihrer fertig konfigurierten Leuchte, um sie gleich mit der passenden Artikelnummer zu bestellen.

NOCH ETWAS UNKLAR?

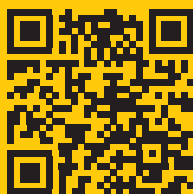

Scanne mich für ein Video, das anschaulich zeigt, wie einfach NUMINOS® Leuchten zu konfigurieren sind.

Zusätzlich zu den bekannten Katalog Icons finden Sie in diesem Kapitel folgende Icons:



Blindungsbewertung



Farbtemperatur



Halbstreuwinkel



Lumen



Steuerung

NUMINOS® XS

NEW VARIANT



DL

XS



Produktangaben:

200mA
 Leistungsaufnahme: 7W
 Material: Aluminium / Polycarbonat (PC)

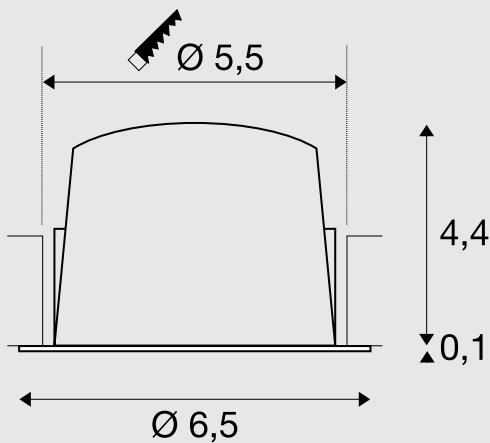

Hinweis:

Niederspannungsstecker
 Treiber exkl.
 Blattfedern liegen dem Produkt bei
 und können ausgetauscht werden.

Passende Treiber, Diffusoren und
 Reduzierringe finden Sie auf den
 Seiten 58-61.



schwarz

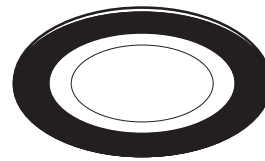

schwarz



weiß



chrom



schwarz

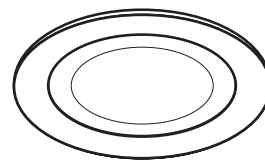

weiß



weiß



chrom

					ART. NR.		
	2700K	640lm	20°	16	1005499		
		620lm	40°	22	1005502		
		640lm	55°	25	1005505		
	3000K	700lm	20°	16	1005517		
		670lm	40°	22	1005520		
		690lm	55°	25	1005523		
	4000K	720lm	20°	16	1005535		
		700lm	40°	22	1005538		
		710lm	55°	25	1005541		
	2700K	670lm	20°	16	1005500		
		650lm	40°	22	1005503		
		670lm	55°	25	1005506		
	3000K	730lm	20°	16	1005518		
		700lm	40°	22	1005521		
		720lm	55°	25	1005524		
	4000K	750lm	20°	16	1005536		
		730lm	40°	22	1005539		
		740lm	55°	25	1005542		
	2700K	670lm	20°	16	1005501		
		650lm	40°	22	1005504		
		670lm	55°	25	1005507		
	3000K	730lm	20°	16	1005519		
		700lm	40°	22	1005522		
		720lm	55°	25	1005525		
	4000K	750lm	20°	16	1005537		
		730lm	40°	22	1005540		
		740lm	55°	25	1005543		
	2700K	640lm	20°	16	1005508		
		620lm	40°	22	1005511		
		640lm	55°	25	1005514		
	3000K	700lm	20°	16	1005526		
		670lm	40°	22	1005529		
		690lm	55°	25	1005532		
	4000K	720lm	20°	16	1005544		
		700lm	40°	22	1005547		
		710lm	55°	25	1005550		
	2700K	670lm	20°	16	1005509		
		650lm	40°	22	1005512		
		670lm	55°	25	1005515		
	3000K	730lm	20°	16	1005527		
		700lm	40°	22	1005530		
		720lm	55°	25	1005533		
	4000K	750lm	20°	16	1005545		
		730lm	40°	22	1005548		
		740lm	55°	25	1005551		
	2700K	670lm	20°	16	1005510		
		650lm	40°	22	1005513		
		670lm	55°	25	1005516		
	3000K	730lm	20°	16	1005528		
		700lm	40°	22	1005531		
		720lm	55°	25	1005534		
	4000K	750lm	20°	16	1005546		
		730lm	40°	22	1005549		
		740lm	55°	25	1005552		

NUMINOS® S



DL



Produktangaben:

250mA

Leistungsaufnahme: 8,6W

Material: Aluminium / Polycarbonat (PC)

Einbaumaße: Ø: 6,8 cm T: 5,5 cm

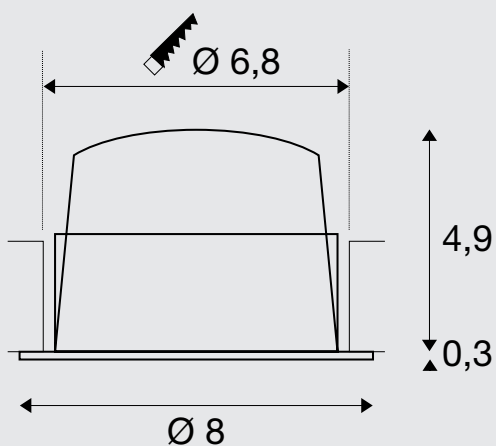

Hinweis:

Niederspannungsstecker

Treiber exkl.

Blattfedern liegen dem Produkt bei und können ausgetauscht werden.

Passende Treiber, Diffusoren und Reduzierringe finden Sie auf den Seiten 58-61.



schwarz

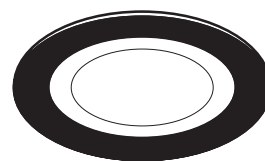

schwarz



weiß



chrom



schwarz

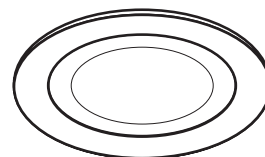

weiß



weiß



chrom

					ART. NR.		
	2700K	670lm	20°	19	1003769		
		670lm	40°	18,5	1003772		
		670lm	55°	22	1003775		
	3000K	690lm	20°	19	1003793		
		690lm	40°	19	1003796		
		690lm	55°	22	1003799		
	4000K	730lm	20°	19	1003817		
		730lm	40°	19	1003820		
		730lm	55°	22	1003823		
	2700K	720lm	20°	18,5	1003770		
		720lm	40°	19	1003773		
		720lm	55°	22	1003776		
	3000K	730lm	20°	19	1003794		
		730lm	40°	19	1003797		
		730lm	55°	22	1003800		
	4000K	790lm	20°	19	1003818		
		790lm	40°	19	1003821		
		790lm	55°	22	1003824		
	2700K	690lm	20°	19	1003771		
		690lm	40°	19	1003774		
		690lm	55°	22	1003777		
	3000K	700lm	20°	19	1003795		
		700lm	40°	19	1003798		
		700lm	55°	19	1003801		
	4000K	750lm	20°	19	1003819		
		750lm	40°	19	1003822		
		750lm	55°	22	1003825		
	2700K	670lm	20°	19	1003781		
		670lm	40°	19	1003784		
		670lm	55°	22	1003787		
	3000K	690lm	20°	19	1003805		
		690lm	40°	19	1003808		
		690lm	55°	22	1003811		
	4000K	730lm	20°	19	1003829		
		730lm	40°	19	1003832		
		730lm	55°	22	1003835		
	2700K	720lm	20°	18,5	1003782		
		720lm	40°	19	1003785		
		720lm	55°	22	1003788		
	3000K	730lm	20°	19	1003806		
		730lm	40°	19	1003809		
		730lm	55°	22	1003812		
	4000K	790lm	20°	19	1003830		
		790lm	40°	19	1003833		
		790lm	55°	22	1003836		
	2700K	690lm	20°	19	1003783		
		690lm	40°	19	1003786		
		690lm	55°	22	1003789		
	3000K	700lm	20°	19	1003807		
		700lm	40°	19	1003810		
		700lm	55°	22	1003813		
	4000K	750lm	20°	19	1003831		
		750lm	40°	19	1003834		
		750lm	55°	22	1003837		

NUMINOS® M



DL

M



Produktangaben:

500mA

Leistungsaufnahme: 17,5W

Material: Aluminium / Polycarbonat (PC)

Einbaumaße: Ø: 9 cm T: 7,5 cm

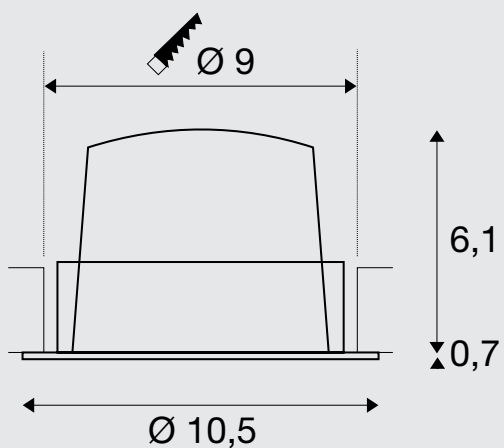
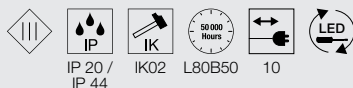

Hinweis:

Niederspannungsstecker

Treiber exkl.

Blattfedern liegen dem Produkt bei und können ausgetauscht werden.

Passende Treiber, Diffusoren und Reduzierringe finden Sie auf den Seiten 58-61.



schwarz

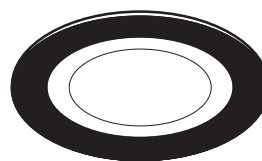

schwarz



weiß



chrom



schwarz

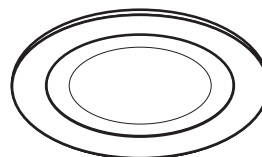

weiß



weiß



chrom

					ART. NR.	
	2700K	1460lm	20°	19	1003841	
		1460lm	40°	22	1003844	
		1460lm	55°	22	1003847	
	3000K	1500lm	20°	19	1003865	
		1500lm	40°	22	1003868	
		1500lm	55°	22	1003871	
	4000K	1600lm	20°	19	1003889	
		1600lm	40°	22	1003892	
		1600lm	55°	22	1003895	
	2700K	1600lm	20°	22	1003842	
		1600lm	40°	19,4	1003845	
		1600lm	55°	22	1003848	
	3000K	1600lm	20°	22	1003866	
		1600lm	40°	22	1003869	
		1600lm	55°	22	1003872	
	4000K	1750lm	20°	22	1003890	
		1750lm	40°	22	1003893	
		1750lm	55°	22	1003896	
	2700K	1550lm	20°	19	1003843	
		1550lm	40°	19	1003846	
		1550lm	55°	19	1003849	
	3000K	1550lm	20°	19	1003867	
		1550lm	40°	19	1003870	
		1550lm	55°	19	1003873	
	4000K	1660lm	20°	19	1003891	
		1660lm	40°	19	1003894	
		1660lm	55°	19	1003897	
	2700K	1460lm	20°	19	1003853	
		1460lm	40°	22	1003856	
		1460lm	55°	22	1003859	
	3000K	1500lm	20°	19	1003877	
		1500lm	40°	22	1003880	
		1500lm	55°	22	1003883	
	4000K	1600lm	20°	19	1003901	
		1600lm	40°	22	1003904	
		1600lm	55°	22	1003907	
	2700K	1600lm	20°	22	1003854	
		1600lm	40°	19	1003857	
		1600lm	55°	22	1003860	
	3000K	1600lm	20°	22	1003878	
		1600lm	40°	22	1003881	
		1600lm	55°	22	1003884	
	4000K	1750lm	20°	22	1003902	
		1750lm	40°	22	1003905	
		1750lm	55°	22	1003908	
	2700K	1550lm	20°	19	1003855	
		1550lm	40°	19	1003858	
		1550lm	55°	19	1003861	
	3000K	1550lm	20°	19	1003879	
		1550lm	40°	19	1003882	
		1550lm	55°	19	1003885	
	4000K	1660lm	20°	19	1003903	
		1660lm	40°	19	1003906	
		1660lm	55°	19	1003909	

NUMINOS® L



DL



Produktangaben:

700mA
 Leistungsaufnahme: 25,4W
 Material: Aluminium / Polycarbonat (PC)
 Einbaumaße: Ø: 11,7 cm T: 9 cm

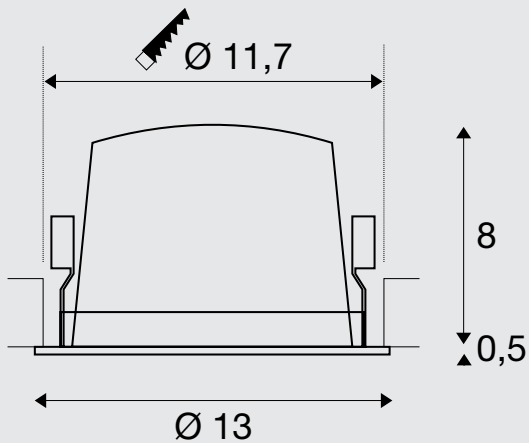

Hinweis:

Niederspannungsstecker
 Treiber exkl.

Passende Treiber, Diffusoren und Reduzierringe finden Sie auf den Seiten 58-61.

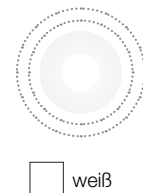
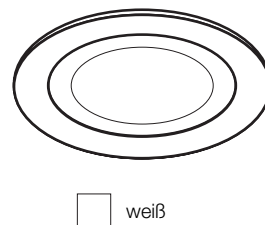
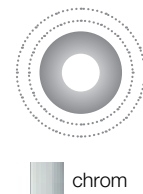
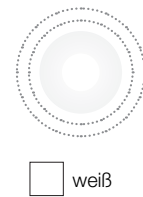
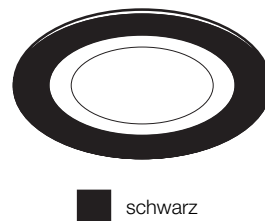

A → G				UGR	ART. NR.		
	2700K	2150lm	20°	22	1003913		
		2150lm	40°	22	1003916		
		2150lm	55°	22	1003919		
	3000K	2150lm	20°	22	1003937		
		2150lm	40°	22	1003940		
		2150lm	55°	25	1003943		
	4000K	2350lm	20°	22	1003961		
		2350lm	40°	22	1003964		
		2350lm	55°	25	1003967		
	2700K	2250lm	20°	19	1003914		
		2250lm	40°	19	1003917		
		2250lm	55°	22	1003920		
	3000K	2300lm	20°	19	1003938		
		2300lm	40°	19	1003941		
		2300lm	55°	20	1003944		
	4000K	2450lm	20°	19	1003962		
		2450lm	40°	19	1003965		
		2450lm	55°	22	1003968		
	2700K	2150lm	20°	19	1003915		
		2150lm	40°	19	1003918		
		2150lm	55°	19	1003921		
	3000K	2200lm	20°	19	1003939		
		2200lm	40°	19	1003942		
		2200lm	55°	19	1003945		
	4000K	2350lm	20°	19	1003963		
		2350lm	40°	19	1003966		
		2350lm	55°	19	1003969		
	2700K	2150lm	20°	22	1003925		
		2150lm	40°	22	1003928		
		2150lm	55°	22	1003931		
	3000K	2150lm	20°	22	1003949		
		2150lm	40°	22	1003952		
		2150lm	55°	25	1003955		
	4000K	2350lm	20°	22	1003973		
		2350lm	40°	22	1003976		
		2350lm	55°	25	1003979		
	2700K	2250lm	20°	19	1003926		
		2250lm	40°	19	1003929		
		2250lm	55°	22	1003932		
	3000K	2300lm	20°	19	1003950		
		2300lm	40°	19	1003953		
		2300lm	55°	22	1003956		
	4000K	2450lm	20°	19	1003974		
		2450lm	40°	19	1003977		
		2450lm	55°	22	1003980		
	2700K	2150lm	20°	19	1003927		
		2150lm	40°	19	1003930		
		2150lm	55°	19	1003933		
	3000K	2200lm	20°	19	1003951		
		2200lm	40°	19	1003954		
		2200lm	55°	19	1003957		
	4000K	2350lm	20°	19	1003975		
		2350lm	40°	19	1003978		
		2350lm	55°	19	1003981		

NUMINOS® XL



DL

XL



Produktangaben:

1050mA
 Leistungsaufnahme: 37,4W
 Material: Aluminium / Polycarbonat (PC)
 Einbaumaße: Ø: 14,5 cm T: 11,5 cm

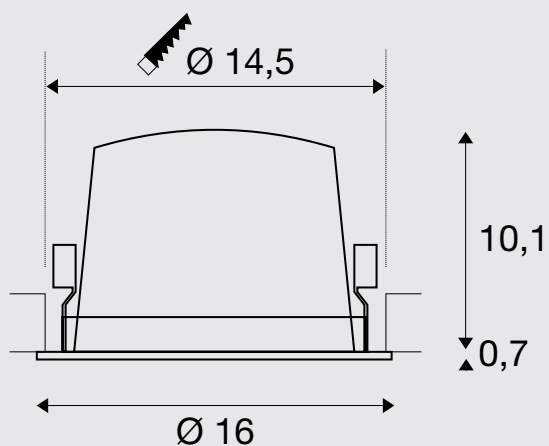
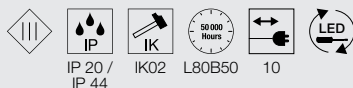

Hinweis:

Niederspannungsstecker
 Treiber exkl.

Passende Treiber, Diffusoren und Reduzierringe finden Sie auf den Seiten 58-61.



schwarz



schwarz



weiß



chrom



schwarz

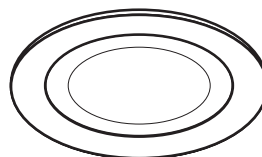

weiß



weiß



chrom



ART. NR.

A to G	Temp	lm	Beam	UGR	ART. NR.		
A to G F	2700K	3300lm	20°	22	1003985		
		3300lm	40°	22	1003988		
		3300lm	55°	22	1003991		
A to G E	3000K	3300lm	20°	22	1004009		
		3300lm	40°	22	1004012		
		3300lm	55°	22	1004015		
A to G E	4000K	3600lm	20°	22	1004033		
		3600lm	40°	22	1004036		
		3600lm	55°	25	1004039		
A to G F	2700K	3500lm	20°	19	1003986		
		3500lm	40°	19	1003989		
		3500lm	55°	19	1003992		
A to G E	3000K	3550lm	20°	19	1004010		
		3550lm	40°	19	1004013		
		3550lm	55°	19	1004016		
A to G E	4000K	3800lm	20°	19	1004034		
		3800lm	40°	19	1004037		
		3800lm	55°	19	1004040		
A to G F	2700K	3400lm	20°	19	1003987		
		3400lm	40°	19	1003990		
		3400lm	55°	19	1003993		
A to G E	3000K	3500lm	20°	19	1004011		
		3500lm	40°	19	1004014		
		3500lm	55°	19	1004017		
A to G E	4000K	3750lm	20°	19	1004035		
		3750lm	40°	19	1004038		
		3750lm	55°	19	1004041		
A to G F	2700K	3300lm	20°	22	1003997		
		3300lm	40°	22	1004000		
		3300lm	55°	22	1004003		
A to G E	3000K	3300lm	20°	22	1004021		
		3300lm	40°	22	1004024		
		3300lm	55°	22	1004027		
A to G E	4000K	3600lm	20°	22	1004045		
		3600lm	40°	22	1004048		
		3600lm	55°	25	1004051		
A to G F	2700K	3500lm	20°	19	1003998		
		3500lm	40°	19	1004001		
		3500lm	55°	19	1004004		
A to G E	3000K	3550lm	20°	19	1004022		
		3550lm	40°	19	1004025		
		3550lm	55°	19	1004028		
A to G E	4000K	3800lm	20°	19	1004046		
		3800lm	40°	19	1004049		
		3800lm	55°	19	1004052		
A to G F	2700K	3400lm	20°	19	1003999		
		3400lm	40°	19	1004002		
		3400lm	55°	19	1004005		
A to G E	3000K	3500lm	20°	19	1004023		
		3500lm	40°	19	1004026		
		3500lm	55°	19	1004029		
A to G E	4000K	3750lm	20°	19	1004047		
		3750lm	40°	19	1004050		
		3750lm	55°	19	1004053		

NUMINOS® MOVE XS

NEW VARIANT



DL

XS



Produktangaben:

200mA

Leistungsaufnahme: 7W

Material: Aluminium / Polycarbonat (PC)

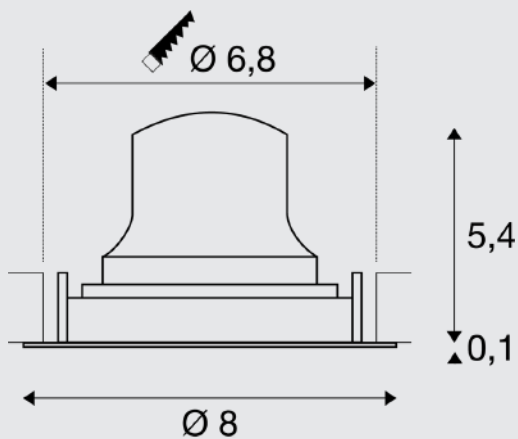

Hinweis:

Niederspannungsstecker
Treiber exkl.

Passende Treiber, Diffusoren und Reduzierringe finden Sie auf den Seiten 58-61.



schwarz

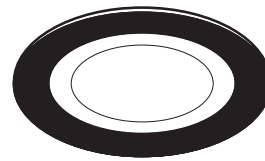

schwarz



weiß



chrom



schwarz

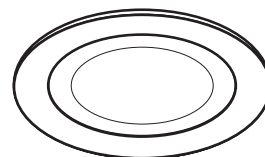

weiß



weiß



chrom

					ART. NR.		
	2700K	640 lm	20°	16	1005553		
		620 lm	40°	22	1005556		
		640 lm	55°	25	1005559		
	3000K	700 lm	20°	16	1005571		
		670 lm	40°	22	1005574		
		690 lm	55°	25	1005577		
	4000K	720 lm	20°	16	1005589		
		700 lm	40°	22	1005592		
		710 lm	55°	25	1005595		
	2700K	670 lm	20°	16	1005554		
		650 lm	40°	22	1005557		
		670 lm	55°	25	1005560		
	3000K	730 lm	20°	16	1005572		
		700 lm	40°	22	1005575		
		720 lm	55°	25	1005578		
	4000K	750 lm	20°	16	1005590		
		730 lm	40°	22	1005593		
		740 lm	55°	25	1005596		
	2700K	670 lm	20°	16	1005555		
		650 lm	40°	22	1005558		
		670 lm	55°	25	1005561		
	3000K	730 lm	20°	16	1005573		
		700 lm	40°	22	1005576		
		720 lm	55°	25	1005579		
	4000K	750 lm	20°	16	1005591		
		730 lm	40°	22	1005594		
		740 lm	55°	25	1005597		
	2700K	640 lm	20°	16	1005562		
		620 lm	40°	22	1005565		
		640 lm	55°	25	1005568		
	3000K	700 lm	20°	16	1005580		
		670 lm	40°	22	1005583		
		690 lm	55°	25	1005586		
	4000K	720 lm	20°	16	1005598		
		700 lm	40°	22	1005603		
		710 lm	55°	25	1005606		
	2700K	670 lm	20°	16	1005563		
		650 lm	40°	22	1005566		
		670 lm	55°	25	1005569		
	3000K	730 lm	20°	16	1005581		
		700 lm	40°	22	1005584		
		720 lm	55°	25	1005587		
	4000K	750 lm	20°	16	1005599		
		730 lm	40°	22	1005604		
		740 lm	55°	25	1005607		
	2700K	670 lm	20°	16	1005564		
		650 lm	40°	22	1005567		
		670 lm	55°	25	1005570		
	3000K	730 lm	20°	16	1005582		
		700 lm	40°	22	1005585		
		720 lm	55°	25	1005588		
	4000K	750 lm	20°	16	1005600		
		730 lm	40°	22	1005605		
		740 lm	55°	25	1005608		

NUMINOS® MOVE S

NEW VARIANT



DL

S



Produktangaben:

250 mA
 Leistungsaufnahme: 8,6W
 Material: Aluminium / Polycarbonat (PC)

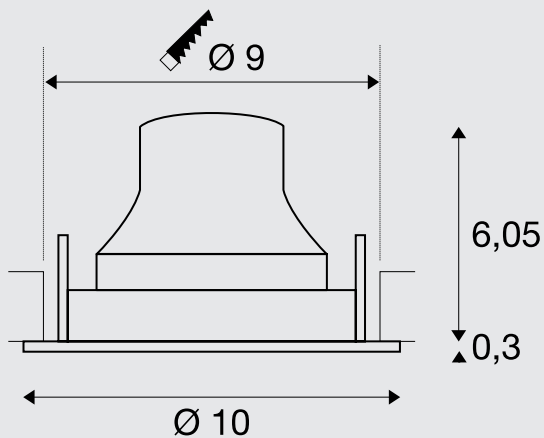

Hinweis:

Niederspannungsstecker
 Treiber exkl.

Passende Treiber, Diffusoren und Reduzierringe finden Sie auf den Seiten 58-61.

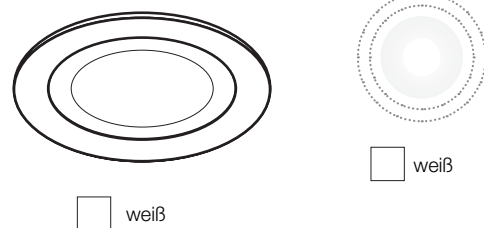
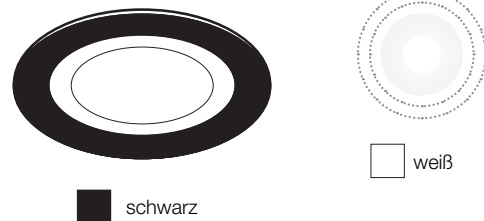

					ART. NR.		
	2700K	670lm	20°	19	1005319		
		670lm	40°	19	1005322		
		670lm	55°	22	1005325		
	3000K	690lm	20°	19	1005337		
		690lm	40°	19	1005340		
		690lm	55°	22	1005343		
	4000K	730lm	20°	19	1005355		
		730lm	40°	19	1005358		
		730lm	55°	22	1005361		
	2700K	720lm	20°	19	1005320		
		720lm	40°	19	1005323		
		720lm	55°	22	1005326		
	3000K	730lm	20°	19	1005338		
		730lm	40°	19	1005341		
		730lm	55°	22	1005344		
	4000K	790lm	20°	19	1005356		
		790lm	40°	19	1005359		
		790lm	55°	22	1005362		
	2700K	690lm	20°	19	1005321		
		690lm	40°	19	1005324		
		690lm	55°	22	1005327		
	3000K	700lm	20°	19	1005339		
		700lm	40°	19	1005342		
		700lm	55°	22	1005345		
	4000K	750lm	20°	19	1005357		
		750lm	40°	19	1005360		
		750lm	55°	22	1005363		
	2700K	670lm	20°	19	1005328		
		670lm	40°	19	1005331		
		670lm	55°	22	1005334		
	3000K	690lm	20°	19	1005346		
		690lm	40°	19	1005349		
		690lm	55°	22	1005352		
	4000K	730lm	20°	19	1005364		
		730lm	40°	19	1005367		
		730lm	55°	22	1005370		
	2700K	720lm	20°	19	1005329		
		720lm	40°	19	1005332		
		720lm	55°	22	1005335		
	3000K	730lm	20°	19	1005347		
		730lm	40°	19	1005350		
		730lm	55°	22	1005353		
	4000K	790lm	20°	19	1005365		
		790lm	40°	19	1005368		
		790lm	55°	22	1005371		
	2700K	690lm	20°	19	1005330		
		690lm	40°	19	1005333		
		690lm	55°	22	1005336		
	3000K	700lm	20°	19	1005348		
		700lm	40°	19	1005351		
		700lm	55°	22	1005354		
	4000K	750lm	20°	19	1005366		
		750lm	40°	19	1005369		
		750lm	55°	22	1005372		

NUMINOS® MOVE M



DL

M



Produktangaben:

500mA

Leistungsaufnahme: 17,5W

Material: Aluminium / Polycarbonat (PC)

Einbaumaße: Ø: 12 cm T: 10 cm

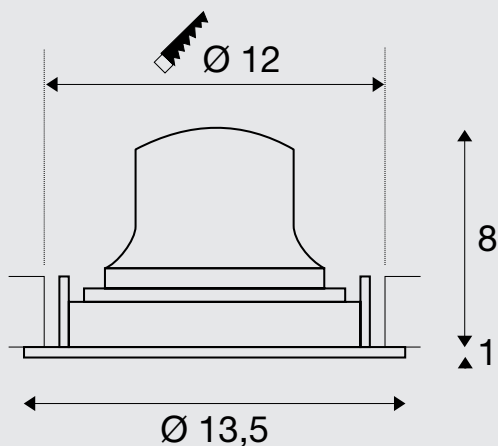

Hinweis:

Niederspannungsstecker

Treiber exkl.

Passende Treiber, Diffusoren und Reduzierringe finden Sie auf den Seiten 58-61.

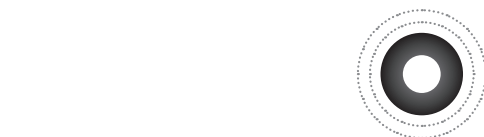

schwarz

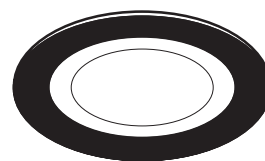

schwarz



weiß



chrom



schwarz

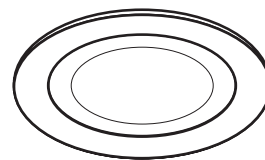

weiß



weiß



chrom

					ART. NR.	
	2700K	1460lm	20°	19	1003553	
		1460lm	40°	22	1003556	
		1460lm	55°	22	1003559	
	3000K	1500lm	20°	19	1003577	
		1500lm	40°	22	1003580	
		1500lm	55°	22	1003583	
	4000K	1600lm	20°	19	1003601	
		1600lm	40°	22	1003604	
		1600lm	55°	22	1003607	
	2700K	1600lm	20°	22	1003554	
		1600lm	40°	19	1003557	
		1600lm	55°	22	1003560	
	3000K	1600lm	20°	22	1003578	
		1600lm	40°	22	1003581	
		1600lm	55°	22	1003584	
	4000K	1750lm	20°	22	1003602	
		1750lm	40°	22	1003605	
		1750lm	55°	22	1003608	
	2700K	1550lm	20°	19	1003555	
		1550lm	40°	19	1003558	
		1550lm	55°	19	1003561	
	3000K	1550lm	20°	19	1003579	
		1550lm	40°	19	1003582	
		1550lm	55°	19	1003585	
	4000K	1660lm	20°	19	1003603	
		1660lm	40°	19	1003606	
		1660lm	55°	19	1003609	
	2700K	1460lm	20°	19	1003565	
		1460lm	40°	22	1003568	
		1460lm	55°	22	1003571	
	3000K	1500lm	20°	19	1003589	
		1500lm	40°	22	1003592	
		1500lm	55°	22	1003595	
	4000K	1600lm	20°	19	1003613	
		1600lm	40°	22	1003616	
		1600lm	55°	22	1003619	
	2700K	1600lm	20°	22	1003566	
		1600lm	40°	22	1003569	
		1600lm	55°	22	1003572	
	3000K	1600lm	20°	22	1003590	
		1600lm	40°	22	1003593	
		1600lm	55°	22	1003596	
	4000K	1750lm	20°	22	1003614	
		1750lm	40°	22	1003617	
		1750lm	55°	22	1003620	
	2700K	1550lm	20°	19	1003567	
		1550lm	40°	19	1003570	
		1550lm	55°	19	1003573	
	3000K	1550lm	20°	19	1003591	
		1550lm	40°	19	1003594	
		1550lm	55°	19	1003597	
	4000K	1660lm	20°	19	1003615	
		1660lm	40°	19	1003618	
		1660lm	55°	19	1003621	

NUMINOS® MOVE L



DL



Produktangaben:

750mA
 Leistungsaufnahme: 25,4W
 Material: Aluminium / Polycarbonat (PC)
 Einbaumaße: Ø: 14,5 cm T: 10,5 cm

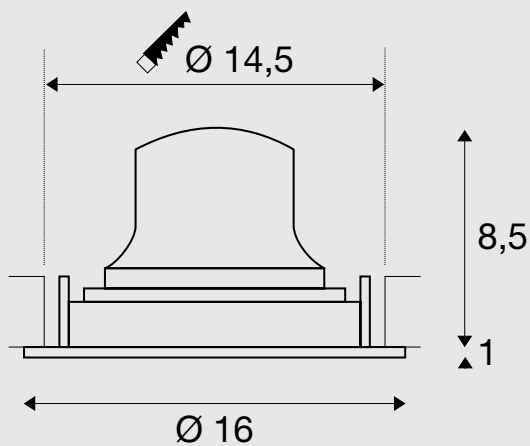

Hinweis:

Niederspannungsstecker
 Treiber exkl.

Passende Treiber, Diffusoren und Reduzierringe finden Sie auf den Seiten 58-61.

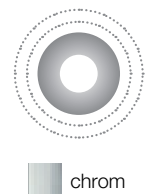
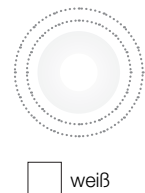
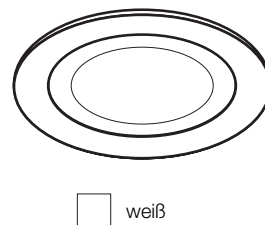
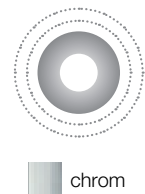
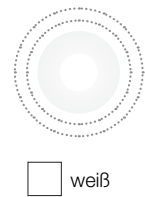
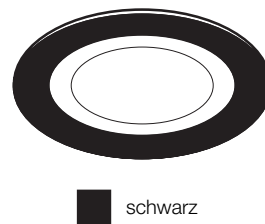

					ART. NR.		
	2700K	2150lm	20°	22	1003625		
		2150lm	40°	22	1003628		
		2150lm	55°	22	1003631		
	3000K	2150lm	20°	22	1003649		
		2150lm	40°	22	1003652		
		2150lm	55°	25	1003655		
	4000K	2350lm	20°	22	1003673		
		2350lm	40°	22	1003676		
		2350lm	55°	25	1003679		
	2700K	2250lm	20°	19	1003626		
		2250lm	40°	19	1003629		
		2250lm	55°	22	1003632		
	3000K	2300lm	20°	19	1003650		
		2300lm	40°	19	1003653		
		2300lm	55°	22	1003656		
	4000K	2450lm	20°	19	1003674		
		2450lm	40°	19	1003677		
		2450lm	55°	22	1003680		
	2700K	2150lm	20°	19	1003627		
		2150lm	40°	19	1003630		
		2150lm	55°	19	1003633		
	3000K	2200lm	20°	19	1003651		
		2200lm	40°	19	1003654		
		2200lm	55°	19	1003657		
	4000K	2350lm	20°	19	1003675		
		2350lm	40°	19	1003678		
		2350lm	55°	19	1003681		
	2700K	2150lm	20°	22	1003637		
		2150lm	40°	22	1003640		
		2150lm	55°	22	1003643		
	3000K	2150lm	20°	22	1003661		
		2150lm	40°	22	1003664		
		2150lm	55°	25	1003667		
	4000K	2350lm	20°	22	1003685		
		2350lm	40°	22	1003688		
		2350lm	55°	25	1003691		
	2700K	2250lm	20°	19	1003638		
		2250lm	40°	19	1003641		
		2250lm	55°	22	1003644		
	3000K	2300lm	20°	19	1003662		
		2300lm	40°	19	1003665		
		2300lm	55°	22	1003668		
	4000K	2450lm	20°	19	1003686		
		2450lm	40°	19	1003689		
		2450lm	55°	22	1003692		
	2700K	2150lm	20°	19	1003639		
		2150lm	40°	19	1003642		
		2150lm	55°	19	1003645		
	3000K	2200lm	20°	19	1003663		
		2200lm	40°	19	1003666		
		2200lm	55°	19	1003669		
	4000K	2350lm	20°	19	1003687		
		2350lm	40°	19	1003690		
		2350lm	55°	19	1003693		

NUMINOS® MOVE XL



DL

XL



Produktangaben:

1050mA
 Leistungsaufnahme: 37,4W
 Material: Aluminium / Polycarbonat (PC)
 Einbaumaße: Ø: 17,5 cm T: 13 cm

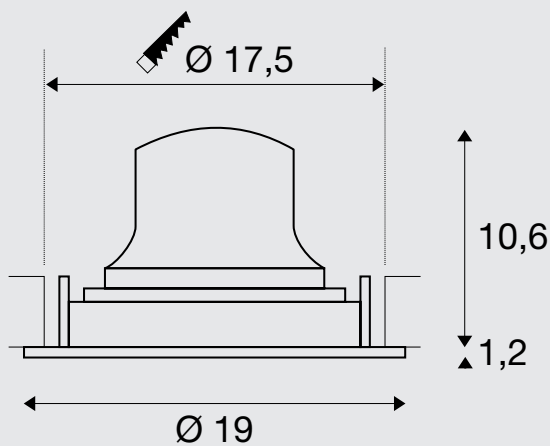

Hinweis:

Niederspannungsstecker
 Treiber exkl.

Passende Treiber, Diffusoren und Reduzierringe finden Sie auf den Seiten 58-61.

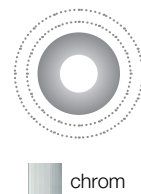
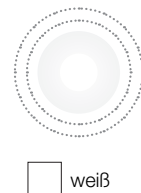
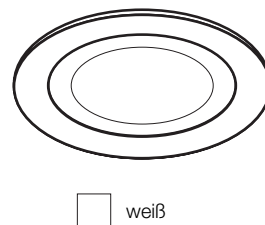
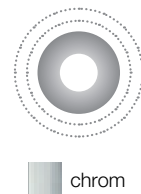
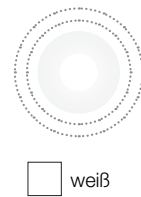
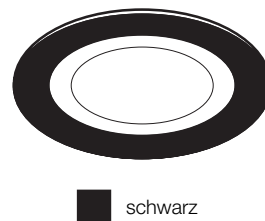

					ART. NR.		
	2700K	3300lm	20°	22	1003697		
		3300lm	40°	22	1003700		
		3300lm	55°	22	1003703		
	3000K	3300lm	20°	22	1003721		
		3300lm	40°	22	1003724		
		3300lm	55°	22	1003727		
	4000K	3600lm	20°	22	1003745		
		3600lm	40°	22	1003748		
		3600lm	55°	25	1003751		
	2700K	3500lm	20°	19	1003698		
		3500lm	40°	19	1003701		
		3500lm	55°	19	1003704		
	3000K	3550lm	20°	19	1003722		
		3550lm	40°	19	1003725		
		3550lm	55°	19	1003728		
	4000K	3800lm	20°	19	1003746		
		3800lm	40°	19	1003749		
		3800lm	55°	19	1003752		
	2700K	3400lm	20°	19	1003699		
		3400lm	40°	19	1003702		
		3400lm	55°	19	1003705		
	3000K	3500lm	20°	19	1003723		
		3500lm	40°	19	1003726		
		3500lm	55°	19	1003729		
	4000K	3750lm	20°	19	1003747		
		3750lm	40°	19	1003750		
		3750lm	55°	19	1003753		
	2700K	3300lm	20°	22	1003709		
		3300lm	40°	22	1003712		
		3300lm	55°	22	1003715		
	3000K	3300lm	20°	22	1003733		
		3300lm	40°	22	1003736		
		3300lm	55°	22	1003739		
	4000K	3600lm	20°	22	1003757		
		3600lm	40°	22	1003760		
		3600lm	55°	25	1003763		
	2700K	3500lm	20°	19	1003710		
		3500lm	40°	19	1003713		
		3500lm	55°	19	1003716		
	3000K	3550lm	20°	19	1003734		
		3550lm	40°	19	1003737		
		3550lm	55°	19	1003740		
	4000K	3800lm	20°	19	1003758		
		3800lm	40°	19	1003761		
		3800lm	55°	19	1003764		
	2700K	3400lm	20°	19	1003711		
		3400lm	40°	19	1003714		
		3400lm	55°	19	1003717		
	3000K	3500lm	20°	19	1003735		
		3500lm	40°	19	1003738		
		3500lm	55°	19	1003741		
	4000K	3750lm	20°	19	1003759		
		3750lm	40°	19	1003762		
		3750lm	55°	19	1003765		

NUMINOS® GIMBLE XS



DL

XS



Produktangaben:

200mA

Leistungsaufnahme: 7W

Material: Aluminium / Polycarbonat (PC)

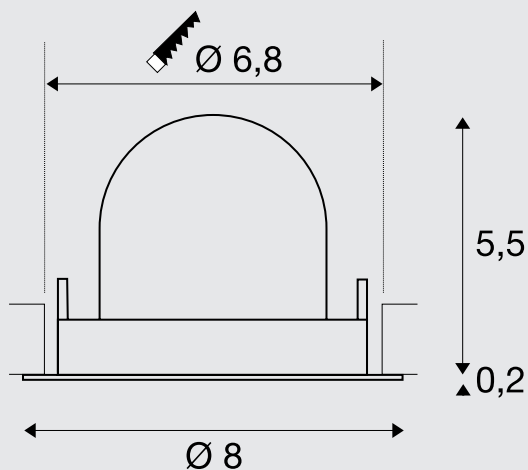
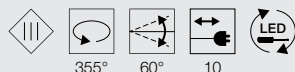

Hinweis:

Niederspannungsstecker
Treiber exkl.

Passende Treiber, Diffusoren und Reduzierringe finden Sie auf den Seiten 58-61.



schwarz

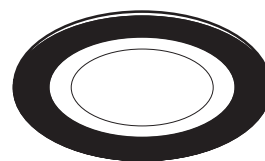

schwarz



weiß



chrom



schwarz

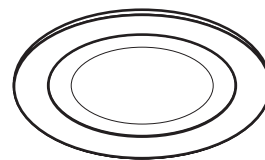

weiß



weiß



chrom

					ART. NR.	
	2700K	640lm	20°	16	1005813	
		620lm	40°	22	1005816	
		640lm	55°	25	1005819	
	3000K	700lm	20°	16	1005831	
		670lm	40°	22	1005834	
		690lm	55°	25	1005837	
	4000K	720lm	20°	16	1005849	
		700lm	40°	22	1005852	
		710lm	55°	25	1005855	
	2700K	670lm	20°	16	1005814	
		650lm	40°	22	1005817	
		670lm	55°	25	1005820	
	3000K	730lm	20°	16	1005832	
		700lm	40°	22	1005835	
		720lm	55°	25	1005838	
	4000K	750lm	20°	16	1005850	
		730lm	40°	22	1005853	
		740lm	55°	25	1005856	
	2700K	670lm	20°	16	1005815	
		650lm	40°	22	1005818	
		670lm	55°	25	1005821	
	3000K	730lm	20°	16	1005833	
		700lm	40°	22	1005836	
		720lm	55°	25	1005839	
	4000K	750lm	20°	16	1005851	
		730lm	40°	22	1005854	
		740lm	55°	25	1005857	
	2700K	640lm	20°	16	1005822	
		620lm	40°	22	1005825	
		640lm	55°	25	1005828	
	3000K	700lm	20°	16	1005840	
		670lm	40°	22	1005843	
		690lm	55°	25	1005846	
	4000K	720lm	20°	16	1005858	
		700lm	40°	22	1005861	
		710lm	55°	25	1005864	
	2700K	670lm	20°	16	1005823	
		650lm	40°	22	1005826	
		670lm	55°	25	1005829	
	3000K	730lm	20°	16	1005841	
		700lm	40°	22	1005844	
		720lm	55°	25	1005847	
	4000K	750lm	20°	16	1005859	
		730lm	40°	22	1005862	
		740lm	55°	25	1005865	
	2700K	670lm	20°	16	1005824	
		650lm	40°	22	1005827	
		670lm	55°	25	1005830	
	3000K	730lm	20°	16	1005842	
		700lm	40°	22	1005845	
		720lm	55°	25	1005848	
	4000K	750lm	20°	16	1005860	
		730lm	40°	22	1005863	
		740lm	55°	25	1005866	

NUMINOS® GIMBLE S

NEW

LED INSIDE



DL

S



Produktangaben:

250mA

Leistungsaufnahme: 8,6 W

Material: Aluminium / Polycarbonat (PC)

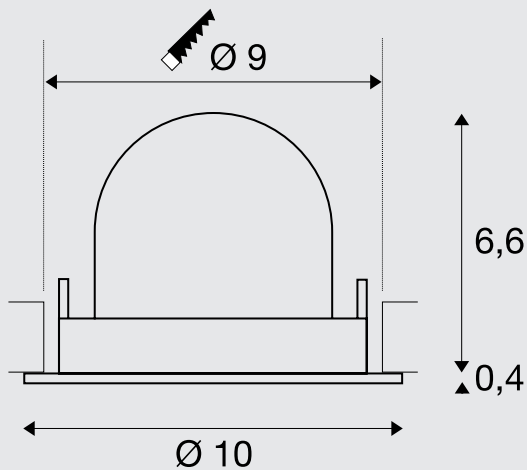
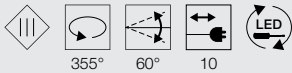

Hinweis:

Niederspannungsstecker
Treiber exkl.

Passende Treiber, Diffusoren und Reduzierringe finden Sie auf den Seiten 58-61.

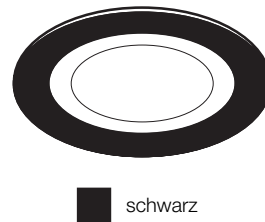

schwarz

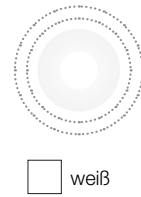

weiß



chrom



schwarz

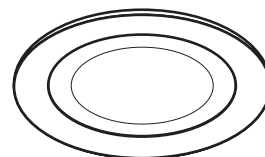

weiß



weiß



chrom

					ART. NR.		
	2700K	670lm	20°	19	1005867		
		670lm	40°	19	1005870		
		670lm	55°	22	1005873		
	3000K	690lm	20°	19	1005885		
		690lm	40°	19	1005888		
		690lm	55°	22	1005891		
	4000K	730lm	20°	19	1005903		
		730lm	40°	19	1005906		
		730lm	55°	22	1005909		
	2700K	720lm	20°	19	1005868		
		720lm	40°	19	1005871		
		720lm	55°	22	1005874		
	3000K	730lm	20°	19	1005886		
		730lm	40°	19	1005889		
		730lm	55°	22	1005892		
	4000K	790lm	20°	19	1005904		
		790lm	40°	19	1005907		
		790lm	55°	22	1005910		
	2700K	690lm	20°	19	1005869		
		690lm	40°	19	1005872		
		690lm	55°	22	1005875		
	3000K	700lm	20°	19	1005887		
		700lm	40°	19	1005890		
		700lm	55°	22	1005893		
	4000K	750lm	20°	19	1005905		
		750lm	40°	19	1005908		
		750lm	55°	22	1005911		
	2700K	670lm	20°	19	1005876		
		670lm	40°	19	1005879		
		670lm	55°	22	1005882		
	3000K	690lm	20°	19	1005894		
		690lm	40°	19	1005897		
		690lm	55°	22	1005900		
	4000K	730lm	20°	19	1005912		
		730lm	40°	19	1005915		
		730lm	55°	22	1005918		
	2700K	720lm	20°	19	1005877		
		720lm	40°	19	1005880		
		720lm	55°	22	1005883		
	3000K	730lm	20°	19	1005895		
		730lm	40°	19	1005898		
		730lm	55°	22	1005901		
	4000K	790lm	20°	19	1005913		
		790lm	40°	19	1005916		
		790lm	55°	22	1005919		
	2700K	690lm	20°	19	1005878		
		690lm	40°	19	1005881		
		690lm	55°	22	1005884		
	3000K	700lm	20°	19	1005896		
		700lm	40°	19	1005899		
		700lm	55°	22	1005902		
	4000K	750lm	20°	19	1005914		
		750lm	40°	19	1005917		
		750lm	55°	22	1005920		

NUMINOS® GIMBLE M



DL

M



Produktangaben:

500mA

Leistungsaufnahme: 17,5W

Material: Aluminium / Polycarbonat (PC)

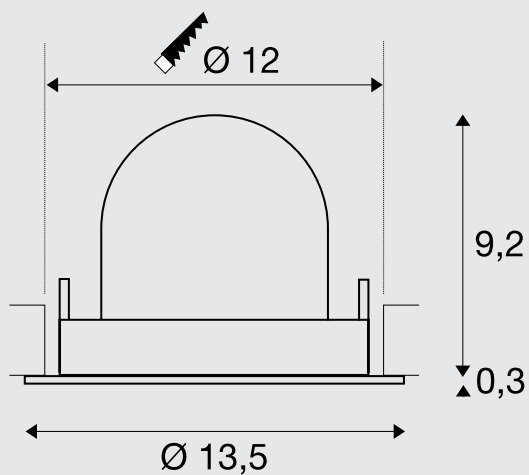
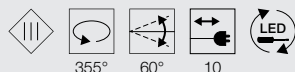

Hinweis:

Niederspannungsstecker
Treiber exkl.

Passende Treiber, Diffusoren und Reduzierringe finden Sie auf den Seiten 58-61.



schwarz

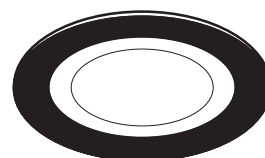

schwarz



weiß



chrom



schwarz

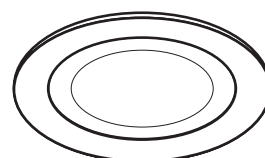

weiß



weiß



chrom

					ART. NR.		
	2700K	1460lm	20°	22	1005921		
		1460lm	40°	22	1005924		
		1460lm	55°	22	1005927		
	3000K	1500lm	20°	22	1005939		
		1500lm	40°	22	1005942		
		1500lm	55°	22	1005945		
	4000K	1600lm	20°	22	1005957		
		1600lm	40°	22	1005960		
		1600lm	55°	22	1005963		
	2700K	1600lm	20°	22	1005922		
		1600lm	40°	22	1005925		
		1600lm	55°	22	1005928		
	3000K	1600lm	20°	22	1005940		
		1600lm	40°	22	1005943		
		1600lm	55°	22	1005946		
	4000K	1750lm	20°	22	1005958		
		1750lm	40°	22	1005961		
		1750lm	55°	22	1005964		
	2700K	1550lm	20°	22	1005923		
		1550lm	40°	22	1005926		
		1550lm	55°	22	1005929		
	3000K	1550lm	20°	22	1005941		
		1550lm	40°	22	1005944		
		1550lm	55°	22	1005947		
	4000K	1660lm	20°	22	1005959		
		1660lm	40°	22	1005962		
		1660lm	55°	22	1005965		
	2700K	1460lm	20°	22	1005930		
		1460lm	40°	22	1005933		
		1460lm	55°	22	1005936		
	3000K	1500lm	20°	22	1005948		
		1500lm	40°	22	1005951		
		1500lm	55°	22	1005954		
	4000K	1600lm	20°	22	1005966		
		1600lm	40°	22	1005969		
		1600lm	55°	22	1005972		
	2700K	1600lm	20°	22	1005931		
		1600lm	40°	22	1005934		
		1600lm	55°	22	1005937		
	3000K	1600lm	20°	22	1005949		
		1600lm	40°	22	1005952		
		1600lm	55°	22	1005955		
	4000K	1750lm	20°	22	1005967		
		1750lm	40°	22	1005970		
		1750lm	55°	22	1005973		
	2700K	1550lm	20°	22	1005932		
		1550lm	40°	22	1005935		
		1550lm	55°	22	1005938		
	3000K	1550lm	20°	22	1005950		
		1550lm	40°	22	1005953		
		1550lm	55°	22	1005956		
	4000K	1660lm	20°	22	1005968		
		1660lm	40°	22	1005971		
		1660lm	55°	22	1005974		

NUMINOS® GIMBLE L

NEW

LED
INSIDE



DL

L



Produktangaben:

700mA

Leistungsaufnahme: 25,4W

Material: Aluminium / Polycarbonat (PC)

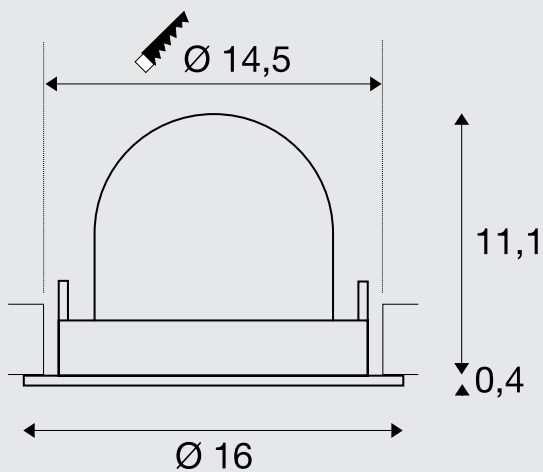
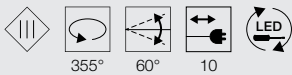

Hinweis:

Niederspannungsstecker
Treiber exkl.

Passende Treiber, Diffusoren und Reduzierringe finden Sie auf den Seiten 58-61.

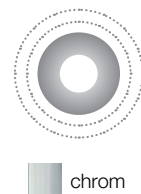
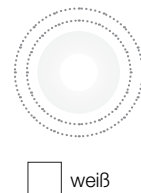
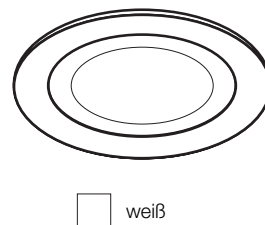
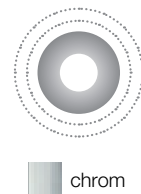
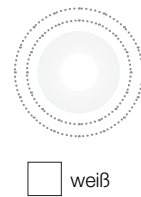
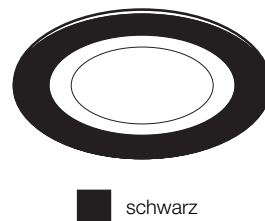

					ART. NR.	
	2700K	2150lm	20°	22	1005975	
		2150lm	40°	22	1005978	
		2150lm	55°	22	1005981	
	3000K	2150lm	20°	22	1005993	
		2150lm	40°	22	1005996	
		2150lm	55°	22	1005999	
	4000K	2350lm	20°	22	1006011	
		2350lm	40°	22	1006014	
		2350lm	55°	22	1006017	
	2700K	2250lm	20°	22	1005976	
		2250lm	40°	22	1005979	
		2250lm	55°	22	1005982	
	3000K	2300lm	20°	22	1005994	
		2300lm	40°	22	1005997	
		2300lm	55°	22	1006000	
	4000K	2450lm	20°	22	1006012	
		2450lm	40°	22	1006015	
		2450lm	55°	22	1006018	
	2700K	2150lm	20°	22	1005977	
		2150lm	40°	22	1005980	
		2150lm	55°	22	1005983	
	3000K	2200lm	20°	22	1005995	
		2200lm	40°	22	1005998	
		2200lm	55°	22	1006001	
	4000K	2350lm	20°	22	1006013	
		2350lm	40°	22	1006016	
		2350lm	55°	22	1006019	
	2700K	2150lm	20°	22	1005984	
		2150lm	40°	22	1005987	
		2150lm	55°	22	1005990	
	3000K	2150lm	20°	22	1006002	
		2150lm	40°	22	1006005	
		2150lm	55°	22	1006008	
	4000K	2350lm	20°	22	1006020	
		2350lm	40°	22	1006023	
		2350lm	55°	22	1006026	
	2700K	2250lm	20°	22	1005985	
		2250lm	40°	22	1005988	
		2250lm	55°	22	1005991	
	3000K	2300lm	20°	22	1006003	
		2300lm	40°	22	1006006	
		2300lm	55°	22	1006009	
	4000K	2450lm	20°	22	1006021	
		2450lm	40°	22	1006024	
		2450lm	55°	22	1006027	
	2700K	2150lm	20°	22	1005986	
		2150lm	40°	22	1005989	
		2150lm	55°	22	1005992	
	3000K	2200lm	20°	22	1006004	
		2200lm	40°	22	1006007	
		2200lm	55°	22	1006010	
	4000K	2350lm	20°	22	1006022	
		2350lm	40°	22	1006025	
		2350lm	55°	22	1006028	

NUMINOS® GIMBLE XL



DL

XL



Produktangaben:

1000/1050mA
 Leistungsaufnahme: 37,4W
 Material: Aluminium / Polycarbonat (PC)

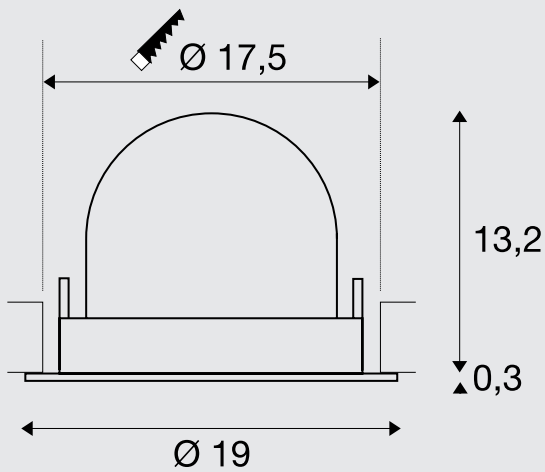
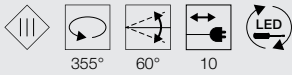

Hinweis:

Niederspannungsstecker
 Treiber exkl.

Passende Treiber, Diffusoren und Reduzierringe finden Sie auf den Seiten 58-61.

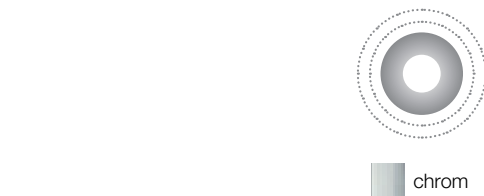
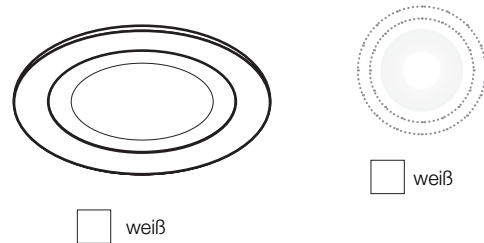
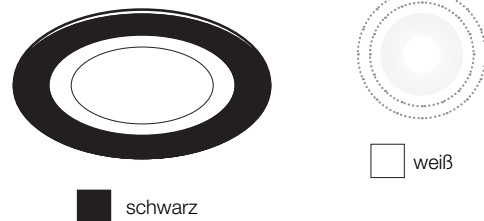

					ART. NR.		
	2700K	3300lm	20°	22	1006029		
		3300lm	40°	22	1006032		
		3300lm	55°	22	1006035		
	3000K	3300lm	20°	22	1006047		
		3300lm	40°	22	1006050		
		3300lm	55°	22	1006053		
	4000K	3600lm	20°	22	1006065		
		3600lm	40°	22	1006068		
		3600lm	55°	22	1006071		
	2700K	3500lm	20°	22	1006030		
		3500lm	40°	22	1006033		
		3500lm	55°	22	1006036		
	3000K	3550lm	20°	22	1006048		
		3550lm	40°	22	1006051		
		3550lm	55°	22	1006054		
	4000K	3800lm	20°	22	1006066		
		3800lm	40°	22	1006069		
		3800lm	55°	22	1006072		
	2700K	3400lm	20°	22	1006031		
		3400lm	40°	22	1006034		
		3400lm	55°	22	1006037		
	3000K	3500lm	20°	22	1006049		
		3500lm	40°	22	1006052		
		3500lm	55°	22	1006055		
	4000K	3750lm	20°	22	1006067		
		3750lm	40°	22	1006070		
		3750lm	55°	22	1006073		
	2700K	3300lm	20°	22	1006038		
		3300lm	40°	22	1006041		
		3300lm	55°	22	1006044		
	3000K	3300lm	20°	22	1006056		
		3300lm	40°	22	1006059		
		3300lm	55°	22	1006062		
	4000K	3600lm	20°	22	1006074		
		3600lm	40°	22	1006077		
		3600lm	55°	22	1006080		
	2700K	3500lm	20°	22	1006039		
		3500lm	40°	22	1006042		
		3500lm	55°	22	1006045		
	3000K	3550lm	20°	22	1006057		
		3550lm	40°	22	1006060		
		3550lm	55°	22	1006063		
	4000K	3800lm	20°	22	1006075		
		3800lm	40°	22	1006078		
		3800lm	55°	22	1006081		
	2700K	3400lm	20°	22	1006040		
		3400lm	40°	22	1006043		
		3400lm	55°	22	1006046		
	3000K	3500lm	20°	22	1006058		
		3500lm	40°	22	1006061		
		3500lm	55°	22	1006064		
	4000K	3750lm	20°	22	1006076		
		3750lm	40°	22	1006079		
		3750lm	55°	22	1006082		



Zubehör





Perfekte Treiberzuordnung

	NEW	NEW	NEW			
	LED Treiber 200mA, 10W QC	LED Treiber 200mA, 10W, PHASE QC	LED Treiber 200mA, 30W, DALI QC	LED Treiber 250mA, 10W	LED Treiber 250mA, 10W, PHASE	LED Treiber 250mA, 20W, DALI
	XS	XS	XS	S	S	S
	200mA	200mA	200mA	250mA	250mA	250/350/500/700mA
Material	Polycarbonat (PC)	Polycarbonat (PC)	Polycarbonat (PC)	Polycarbonat (PC)	Polycarbonat (PC)	Polycarbonat (PC)
Farbe	weiß	weiß	weiß	weiß	weiß	weiß
Spannung prim.	200-240V ~50/60Hz	200-240V ~50/60Hz	200-240V ~50/60Hz	220-240V ~50/60Hz	220-240V ~50/60Hz	220-240V ~50/60Hz
Spannung sek.	29-42V DC	30-42V DC	15-54V DC	26-40V	30-42V	6-60V
Ausgangsstrom	200mA	200mA	200mA	250mA	250mA	250mA
Anzahl Ausgänge sek.	1	1	1	1	1	1
Leistung von	5,8W	6W	3,8W	6,5W	7,5W	1,5W
Leistung bis	8,4W	8,4W	13,5W	10W	10W	15W
Umgebungstemp. min.	-	-	-	-20°C	-20°C	-20°C
Umgebungstemp. max.	-	-	-	45°C	50°C	50°C
Temperaturschutz	110°C	110°C	110°C	110°C	110°C	110°C
IP-Schutzart	IP 20	IP 20	IP 20	IP 20	IP 20	IP 20
Dimmbar	-	PHASE C	DALI	-	PHASE C	DALI
Länge	6,5 cm	8,5 cm	18 cm	6,5 cm	8,5 cm	15 cm
Breite	3,9 cm	4,1 cm	4,5 cm	3,9 cm	3,9 cm	5,2 cm
Höhe	3,5 cm	3 cm	3 cm	2 cm	2,2 cm	2,8 cm
Art. Nr.	1005610	1005609	1005611	1004058	1004055	1004067

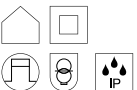
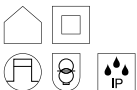
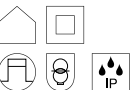
Diffusoren

	XS				S			
	NEW	NEW	NEW	NEW				
	Diffusor elliptisch	Diffusor prismatisch	Diffusor gefrostet	Diffusor Wabe	Diffusor elliptisch	Diffusor prismatisch	Diffusor gefrostet	Diffusor Wabe
Art. Nr.	1005612	1005613	1005614	1005615	1004786	1004787	1004788	1004789

			
	LED Treiber 500mA, 30W	LED Treiber 500mA, 30W, PHASE	LED Treiber 500mA, 40W, DALI
	M	M	M
			
	500/600/700mA	500mA	250/350/500/700mA
Material	Polycarbonat (PC)	Polycarbonat (PC)	Polycarbonat (PC)
Farbe	weiß	weiß	weiß
Spannung prim.	220-240V ~50/60Hz	220-240V ~50/60Hz	220-240V ~50/60Hz
Spannung sek.	30-42V	25-42V	6-58V
Ausgangsstrom	500mA	500mA	500mA
Anzahl Ausgänge sek.	1	1	1
Leistung von	15W	12,5W	1,5W
Leistung bis	29,5W	21W	40,6W
Umgebungstemp. min.	-20°C	-25°C	-25°C
Umgebungstemp. max.	50°C	50°C	50°C
Temperaturschutz	110°C	110°C	110°C
IP-Schutzart	IP 20	IP 20	IP 20
Dimmbar	-	PHASE C	DALI
Länge	14,7 cm	11,5 cm	12,3 cm
Breite	4,3 cm	4,1 cm	7,9 cm
Höhe	3 cm	2,5 cm	2,4 cm
Art. Nr.	1004064	1004054	1004069

	M			
				
	Diffusor elliptisch	Diffusor prismatisch	Diffusor gefrostet	Diffusor Wabe
Art. Nr.	1004790	1004791	1004792	1004793

Zubehör

Perfekte Treiberzuordnung

	LED Treiber 1050mA, 40W	LED Treiber 700mA, 30W, PHASE	LED Treiber 700mA, 40W, DALI	LED Treiber 1050mA, 40W	LED Treiber 1000mA, 40W, PHASE	LED Treiber 1050mA, 50W, DALI
	L	L	L	XL	XL	XL
	500/600/700mA	700mA	700mA	800/900/1050mA	1000mA	1050mA
Material	Polycarbonat (PC)	Polycarbonat (PC)	Polycarbonat (PC)	Polycarbonat (PC)	Polycarbonat (PC)	Polycarbonat (PC)
Farbe	weiß	weiß	weiß	weiß	weiß	weiß
Spannung prim.	220-240V ~50/60Hz	220-240V ~50/60Hz	220-240V ~50/60Hz	220-240V ~50/60Hz	220-240V ~50/60Hz	220-240V ~50/60Hz
Spannung sek.	30-42V	30-42V	6-58V	30-42V	25-40V	6-58V
Ausgangsstrom	700mA	700mA	250/350/500/700mA	1050mA	1050mA	1050mA
Anzahl Ausgänge sek.	1	1	1	1	1	1
Leistung von	15W	21W	1,5W	24W	26,3W	4,2W
Leistung bis	29,5W	29,4W	40,6W	44W	42W	50W
Umgebungstemp. min.	-20°C	-20°C	-25°C	-20°C	-20°C	-25°C
Umgebungstemp. max.	50°C	50°C	50°C	50°C	50°C	50°C
Temperaturschutz	110°C	110°C	110°C	110°C	110°C	110°C
IP-Schutzart	IP 20	IP 20	IP 20	IP 20	IP 20	IP 20
Dimmbar	-	PHASE C	DALI	-	PHASE C	DALI
Länge	14,7 cm	11,5 cm	12,3 cm	9,7 cm	14,5 cm	12,3 cm
Breite	4,3 cm	4,4 cm	7,9 cm	4,3 cm	4 cm	7,9 cm
Höhe	3 cm	3 cm	2,4 cm	3 cm	3 cm	2,4 cm
Art. Nr.	1004062	1004065	1004070	1004059	1004066	1004071

Diffusoren

	L				XL			
	Diffusor elliptisch	Diffusor prismatisch	Diffusor gefrostet	Diffusor Wabe	Diffusor elliptisch	Diffusor prismatisch	Diffusor gefrostet	Diffusor Wabe
Art. Nr.	1004794	1004795	1004796	1004797	1004798	1004799	1004800	1004801

NEW

ZEIT FÜR VERÄNDERUNG. ZEIT FÜR EIN UPDATE.

Eine veraltete, oft noch mit konventionellen Leuchtmitteln ausgestattete Deckeneinbauleuchte soll einer energieeffizienten und kostensparenden Alternative weichen. Bei der Demontage finden Sie dabei häufig einen größeren Deckenausschnitt vor als benötigt.

Hier bietet SLV die passende Lösung – unsere neuen Reduzierringe.

Die Reduzierringe decken den größeren Deckenausschnitt komplett ab und geben gleichzeitig Ihrer neuen, kompakten Deckeneinbauleuchte perfekten Halt.

Sauber, zeitsparend, unkompliziert.

Und dabei perfekt abgestimmt auf das NUMINOS® Down – und Spotlightsystem.



1. Alte Deckeneinbauleuchte mit größerem Deckenausschnitt.



2. Deinstallation der alten Deckeneinbauleuchte.



3. Einsetzen des Reduzierrings.



4. Reduzierring eingebaut. Größerer Deckenausschnitt gänzlich abgedeckt.



5. Elektrischer Anschluss und Installation der neuen Deckeneinbauleuchte.



6. Neue Deckeneinbauleuchte in Reduzierring platziert.

Reduzierring rund



Material	Stahl	Stahl	Stahl	Stahl	Stahl
Außen-Ø	16 cm	16 cm	24 cm	24 cm	24 cm
Höhe	5,3 cm	5,3 cm	5,3 cm	5,3 cm	5,3 cm
Innen-Ø	7 cm	9 cm	12 cm	15 cm	18 cm
Deckenausschnitt	8,5 - 13 cm	12 - 15 cm	14 - 18 cm	17 - 20 cm	20 - 22 cm
Materialdicke	3 cm	3 cm	3 cm	3 cm	3 cm
Art. Nr. schwarz	1006135	1006139	1006143	1006147	1006151
Art. Nr. weiß	1006136	1006140	1006144	1006148	1006152

Reduzierring eckig



Material	Stahl	Stahl	Stahl	Stahl	Stahl
Länge	16 cm	16 cm	24 cm	24 cm	24 cm
Breite	16 cm	16 cm	24 cm	24 cm	24 cm
Höhe	5,3 cm	5,3 cm	5,3 cm	5,3 cm	5,3 cm
Innen-Ø	7 cm	9 cm	12 cm	15 cm	18 cm
Deckenausschnitt	8,5 - 13 cm	12 - 15 cm	14 - 18 cm	17 - 20 cm	20 - 22 cm
Materialdicke	3 cm	3 cm	3 cm	3 cm	3 cm
Art. Nr. schwarz	1006137	1006141	1006145	1006149	1006153
Art. Nr. weiß	1006138	1006142	1006146	1006150	1006154

NUMINOS® S



3Ph.

Produktangaben:

220-240V ~50/60Hz | 250mA

Systemleistung: 11W

Material: Aluminium / Polycarbonat (PC)



L80B50

350°

90°

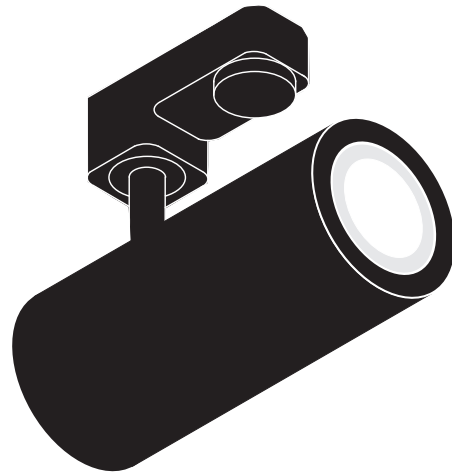
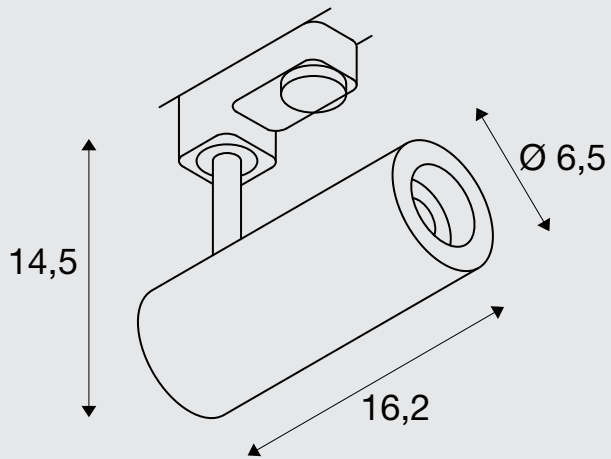

■ schwarz

Hinweis:

Zierring auch in weiß erhältlich



Zierring S

□ weiß

Art. Nr. 1006167

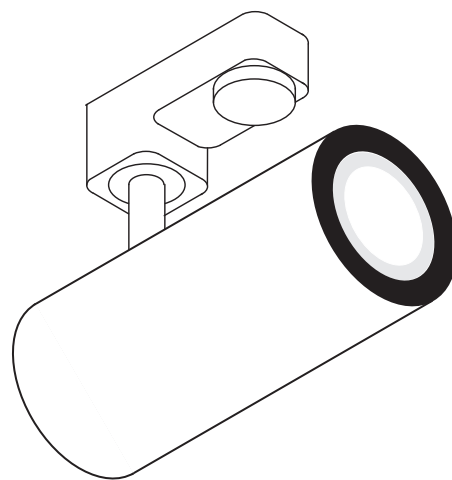

□ weiß



ART. NR.



			985lm	24°	16	1004074
A F	2700K		985lm	36°	16	1004075
			980lm	60°	19	1004076
A E	3000K		1020lm	24°	13	1004082
			1020lm	36°	13	1004083
			1020lm	60°	19	1004084
A E	4000K		1100lm	24°	16	1004090
			1100lm	36°	16	1004091
			1100lm	60°	19	1004092



			985lm	24°	16	1004362
A F	2700K		985lm	36°	16	1004363
			980lm	60°	19	1004364
A E	3000K		1020lm	24°	13	1004370
			1020lm	36°	13	1004371
			1020lm	60°	19	1004372
A E	4000K		1100lm	24°	16	1004378
			1100lm	36°	16	1004379
			1100lm	60°	19	1004380



			985lm	24°	16	1004078
A F	2700K		985lm	36°	16	1004079
			980lm	60°	19	1004080
A E	3000K		1020lm	24°	13	1004086
			1020lm	36°	13	1004087
			1020lm	60°	19	1004088
A E	4000K		1100lm	24°	16	1004094
			1100lm	36°	16	1004095
			1100lm	60°	19	1004096



			985lm	24°	16	1004366
A F	2700K		985lm	36°	16	1004367
			980lm	60°	19	1004368
A E	3000K		1020lm	24°	13	1004374
			1020lm	36°	13	1004375
			1020lm	60°	19	1004376
A E	4000K		1100lm	24°	16	1004382
			1100lm	36°	16	1004383
			1100lm	60°	19	1004384



NUMINOS® M



3Ph.

Produktangaben:

220-240V ~50/60Hz | 500mA

Systemleistung: 20W

Material: Aluminium / Polycarbonat (PC)

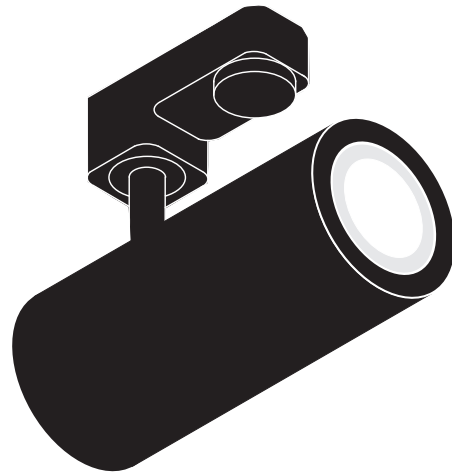
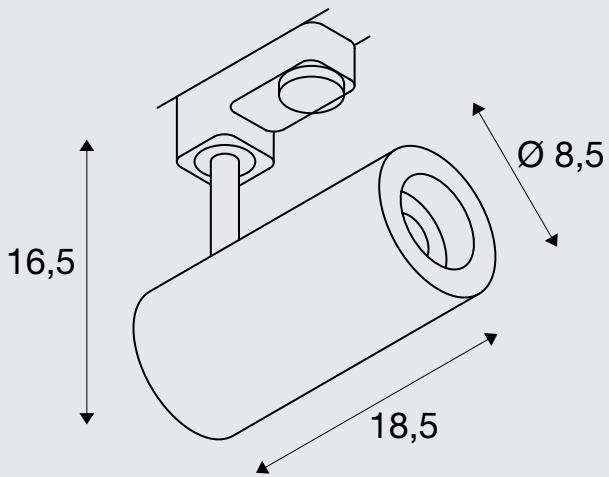

■ schwarz

Hinweis:

Zierring auch in weiß erhältlich



Zierring M weiß Art. Nr. 1006168

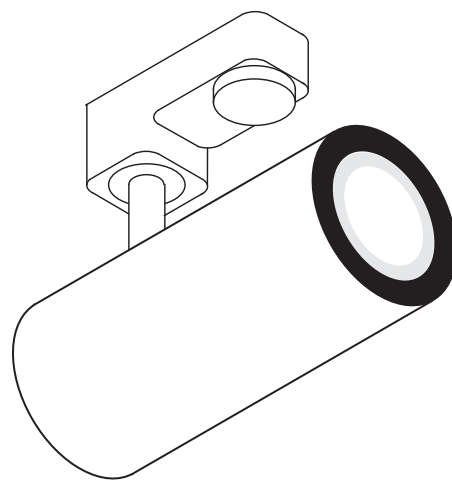

□ weiß



ART. NR.



			1925lm	24°	16	1004170
	2700K		1935lm	36°	16	1004171
			1885lm	60°	22	1004172
	3000K		1955lm	24°	16	1004178
			1970lm	36°	13	1004179
	4000K		1880lm	60°	22	1004180
			2125lm	24°	19	1004186
			2120lm	36°	16	1004187
			2060lm	60°	25	1004188



			1925lm	24°	16	1004458
	2700K		1935lm	36°	16	1004459
			1885lm	60°	22	1004460
	3000K		1955lm	24°	16	1004466
			1970lm	36°	13	1004467
	4000K		1880lm	60°	22	1004468
			2125lm	24°	19	1004474
			2120lm	36°	16	1004475
			2060lm	60°	25	1004476



			1925lm	24°	16	1004174
	2700K		1935lm	36°	16	1004175
			1885lm	60°	22	1004176
	3000K		1955lm	24°	16	1004182
			1970lm	36°	13	1004183
	4000K		1880lm	60°	22	1004184
			2125lm	24°	19	1004190
			2120lm	36°	16	1004191
			2060lm	60°	25	1004192



			1925lm	24°	16	1004462
	2700K		1935lm	36°	16	1004463
			1885lm	60°	22	1004464
	3000K		1955lm	24°	16	1004470
			1970lm	36°	13	1004471
	4000K		1880lm	60°	22	1004472
			2125lm	24°	19	1004478
			2120lm	36°	16	1004479
			2060lm	60°	25	1004480



NUMINOS® L



3Ph.

Produktangaben:

220-240V ~50/60Hz | 700mA

Systemleistung: 28W

Material: Aluminium / Polycarbonat (PC)

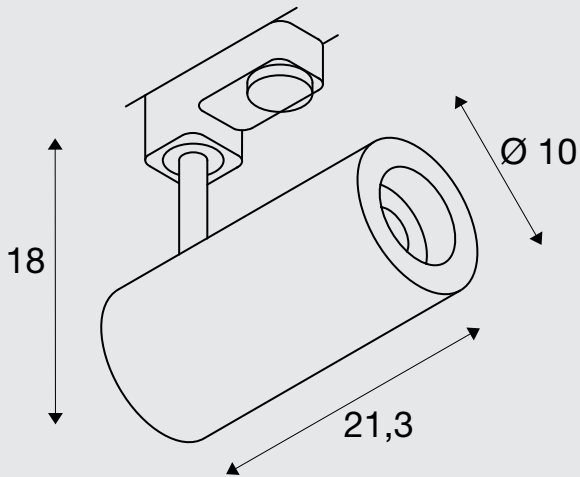

Hinweis:

Zierring auch in weiß erhältlich

Zierring L weiß Art. Nr. 1006169

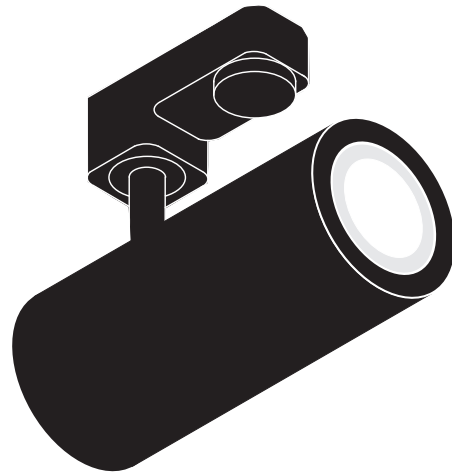

schwarz

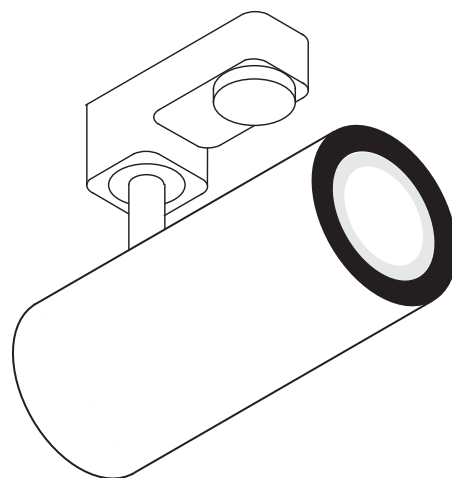

weiß



ART. NR.



			2440lm	24°	19	1004266
	2700K		2400lm	36°	19	1004267
			2475lm	60°	22	1004268
	3000K		2430lm	24°	13	1004274
			2340lm	36°	13	1004275
			2400lm	60°	22	1004276
	4000K		2675lm	24°	19	1004282
			2620lm	36°	19	1004283
			2715lm	60°	22	1004284



			2440lm	24°	19	1004554
	2700K		2400lm	36°	19	1004555
			2475lm	60°	22	1004556
	3000K		2430lm	24°	13	1004562
			2340lm	36°	13	1004563
			2400lm	60°	22	1004564
	4000K		2675lm	24°	19	1004570
			2620lm	36°	19	1004571
			2715lm	60°	22	1004572



			2440lm	24°	19	1004270
	2700K		2400lm	36°	19	1004271
			2475lm	60°	22	1004272
	3000K		2430lm	24°	13	1004278
			2340lm	36°	13	1004279
			2400lm	60°	22	1004280
	4000K		2675lm	24°	19	1004286
			2620lm	36°	19	1004287
			2715lm	60°	22	1004288

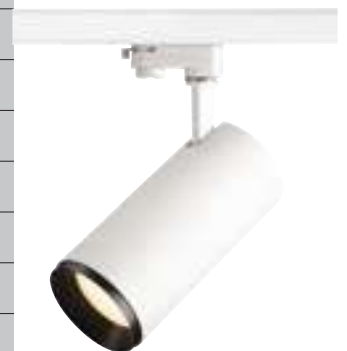

			2440lm	24°	19	1004558
	2700K		2400lm	36°	19	1004559
			2475lm	60°	22	1004560
	3000K		2430lm	24°	13	1004566
			2340lm	36°	13	1004567
			2400lm	60°	22	1004568
	4000K		2675lm	24°	19	1004574
			2620lm	36°	19	1004575
			2715lm	60°	22	1004576



NUMINOS® XL

NEW VARIANT



3Ph.

Produktangaben:

220-240V ~50/60Hz | 900mA

Systemleistung: 36W

Material: Aluminium / Polycarbonat (PC)

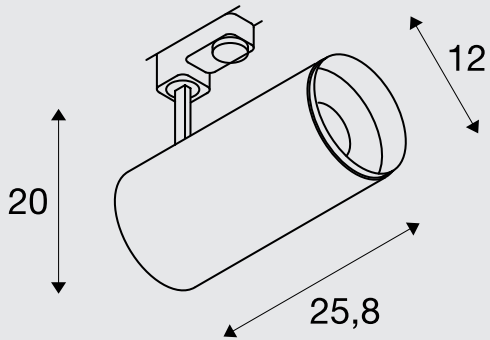

Hinweis:

Zierring auch in weiß erhältlich

Zierring XL

weiß

Art. Nr. 1006170

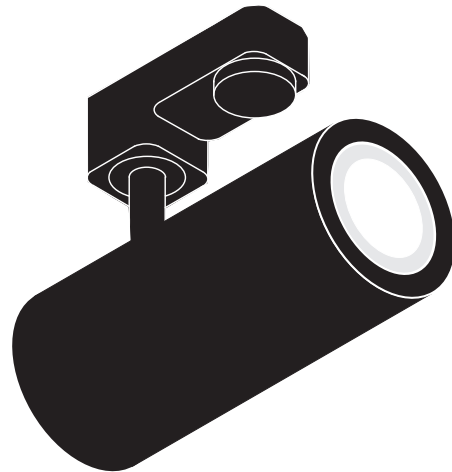

schwarz

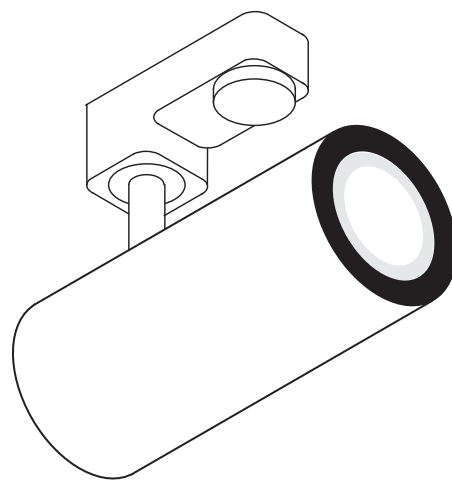

weiß



A → G



UGR

ART. NR.



			3290lm	24°	19	1005723
	2700K		3250lm	36°	19	1005724
			2980lm	60°	25	1005725
	3000K		3530lm	24°	19	1005729
			3490lm	36°	19	1005730
			3210lm	60°	25	1005731
	4000K		3800lm	24°	19	1005735
			3760lm	36°	19	1005736
			3460lm	60°	25	1005737



			3290lm	24°	19	1005795
	2700K		3250lm	36°	19	1005796
			2980lm	60°	25	1005797
	3000K		3530lm	24°	19	1005801
			3490lm	36°	19	1005802
			3210lm	60°	25	1005803
	4000K		3800lm	24°	19	1005807
			3760lm	36°	19	1005808
			3460lm	60°	25	1005809



			3290lm	24°	19	1005726
	2700K		3250lm	36°	19	1005727
			2980lm	60°	25	1005728
	3000K		3530lm	24°	19	1005732
			3490lm	36°	19	1005733
			3210lm	60°	25	1005734
	4000K		3800lm	24°	19	1005738
			3760lm	36°	19	1005739
			3460lm	60°	25	1005740



			3290lm	24°	19	1005798
	2700K		3250lm	36°	19	1005799
			2980lm	60°	25	1005800
	3000K		3530lm	24°	19	1005804
			3490lm	36°	19	1005805
			3210lm	60°	25	1005806
	4000K		3800lm	24°	19	1005810
			3760lm	36°	19	1005811
			3460lm	60°	25	1005812



NUMINOS® ZOOM M



3Ph.

Produktangaben:

220-240V ~50/60Hz | 500mA

Systemleistung: 20W

Material: Aluminium / Polycarbonat (PC)

- Halbstreuwinkel einstellbar von 15°-60°.

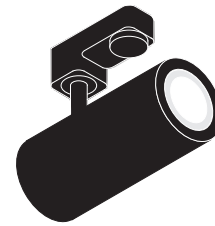
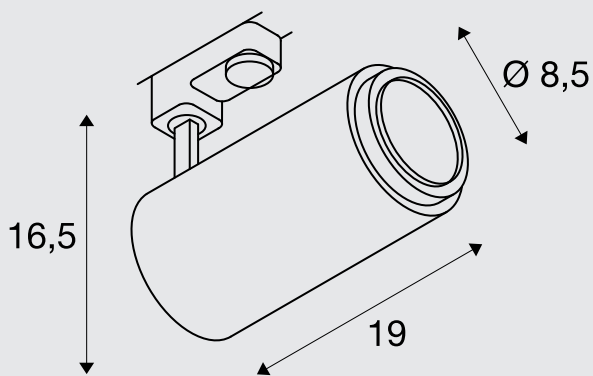
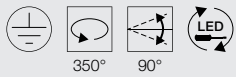

■ schwarz

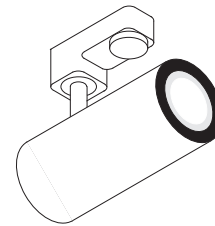

□ weiß





A → G



UGR

ART. NR.



A → G E

2700K 680-1650lm 15°-60° 25 **1006108**

3000K 750-1800lm 15°-60° 25 **1006110**

4000K 780-1900lm 15°-60° 25 **1006112**



A → G E

2700K 680-1650lm 15°-60° 25 **1006114**

3000K 750-1800lm 15°-60° 25 **1006116**

4000K 780-1900lm 15°-60° 25 **1006118**



A → G E

2700K 680-1650lm 15°-60° 25 **1006109**

3000K 750-1800lm 15°-60° 25 **1006111**

4000K 780-1900lm 15°-60° 25 **1006113**



A → G E

2700K 680-1650lm 15°-60° 25 **1006115**

3000K 750-1800lm 15°-60° 25 **1006117**

4000K 780-1900lm 15°-60° 25 **1006119**



NUMINOS® S



CW

Produktangaben:

220-240V ~50/60Hz | 250mA

Systemleistung: 11W

Material: Aluminium / Polycarbonat (PC)

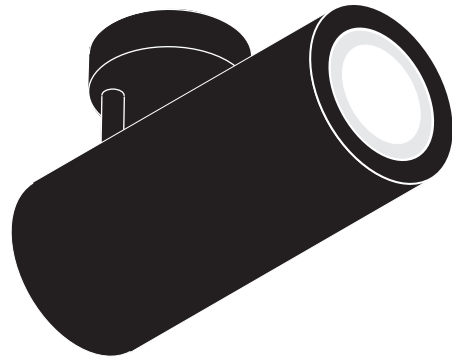
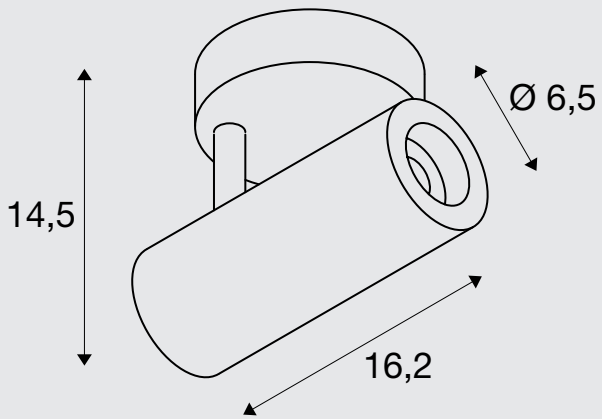

■ schwarz

Hinweis:

Zierring auch in weiß erhältlich



Zierring S □ weiß Art. Nr. 1006167

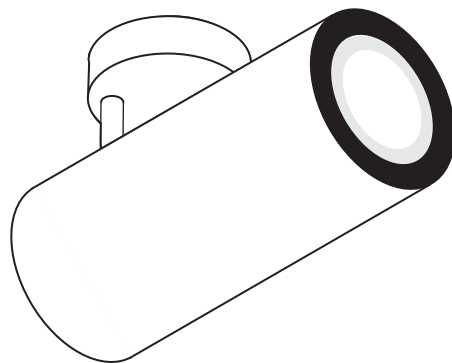

□ weiß



ART. NR.



		985lm	24°	16	1004098
	2700K	985lm	36°	16	1004099
		980lm	60°	19	1004100
	3000K	1020lm	24°	13	1004106
		1020lm	36°	13	1004107
		1020lm	60°	19	1004108
	4000K	1100lm	24°	16	1004114
		1100lm	36°	16	1004115
		1100lm	60°	19	1004116



		985lm	24°	16	1004386
	2700K	985lm	36°	16	1004387
		980lm	60°	19	1004388
	3000K	1020lm	24°	13	1004394
		1020lm	36°	13	1004395
		1020lm	60°	19	1004396
	4000K	1100lm	24°	16	1004402
		1100lm	36°	16	1004403
		1100lm	60°	19	1004404



		985lm	24°	16	1004102
	2700K	985lm	36°	16	1004103
		980lm	60°	19	1004104
	3000K	1020lm	24°	13	1004110
		1020lm	36°	13	1004111
		1020lm	60°	19	1004112
	4000K	1100lm	24°	16	1004118
		1100lm	36°	16	1004119
		1100lm	60°	19	1004120



		985lm	24°	16	1004390
	2700K	985lm	36°	16	1004391
		980lm	60°	19	1004392
	3000K	1020lm	24°	13	1004398
		1020lm	36°	13	1004399
		1020lm	60°	19	1004400
	4000K	1100lm	24°	16	1004406
		1100lm	36°	16	1004407
		1100lm	60°	19	1004408



NUMINOS® M



CL

Produktangaben:

220-240V ~50/60Hz | 500mA

Systemleistung: 20W

Material: Aluminium / Polycarbonat (PC)

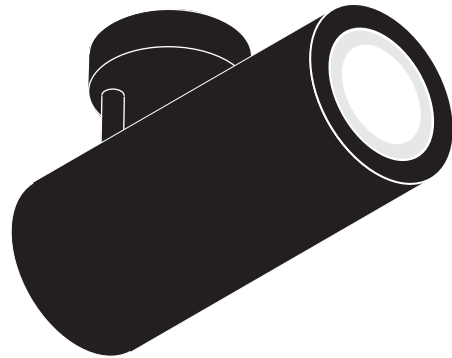
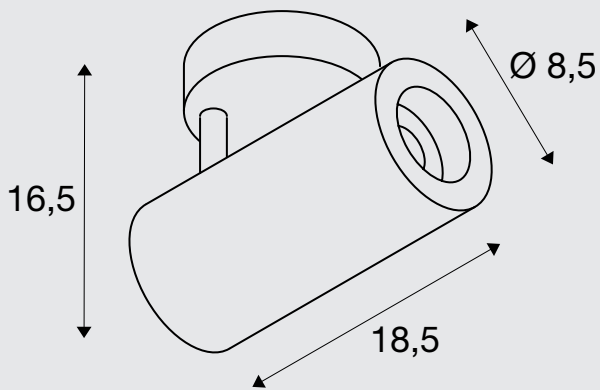

■ schwarz

Hinweis:

Zierring auch in weiß erhältlich



Zierring M □ weiß Art. Nr. 1006168

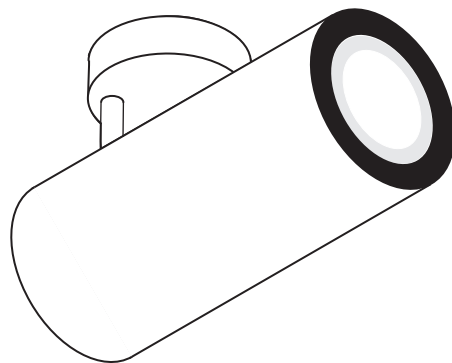

□ weiß



ART. NR.



			1925lm	24°	16	1004194
	2700K		1935lm	36°	16	1004195
			1885lm	60°	22	1004196
	3000K		1955lm	24°	16	1004202
			1970lm	36°	13	1004203
			1880lm	60°	22	1004204
	4000K		2125lm	24°	19	1004210
			2120lm	36°	16	1004211
			2060lm	60°	25	1004212



			1925lm	24°	16	1004482
	2700K		1935lm	36°	16	1004483
			1885lm	60°	22	1004484
	3000K		1955lm	24°	16	1004490
			1970lm	36°	13	1004491
			1880lm	60°	22	1004492
	4000K		2125lm	24°	19	1004498
			2120lm	36°	16	1004499
			2060lm	60°	25	1004500



			1925lm	24°	16	1004198
	2700K		1935lm	36°	16	1004199
			1885lm	60°	22	1004200
	3000K		1955lm	24°	16	1004206
			1970lm	36°	13	1004207
			1880lm	60°	22	1004208
	4000K		2125lm	24°	19	1004214
			2120lm	36°	16	1004215
			2060lm	60°	25	1004216



			1925lm	24°	16	1004486
	2700K		1935lm	36°	16	1004487
			1885lm	60°	22	1004488
	3000K		1955lm	24°	16	1004494
			1970lm	36°	13	1004495
			1880lm	60°	22	1004496
	4000K		2125lm	24°	19	1004502
			2120lm	36°	16	1004503
			2060lm	60°	25	1004504



NUMINOS® L



CL

Produktangaben:

220-240V ~50/60Hz | 700mA

Systemleistung: 28W

Material: Aluminium / Polycarbonat (PC)

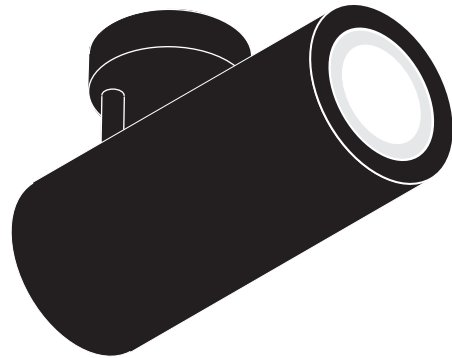
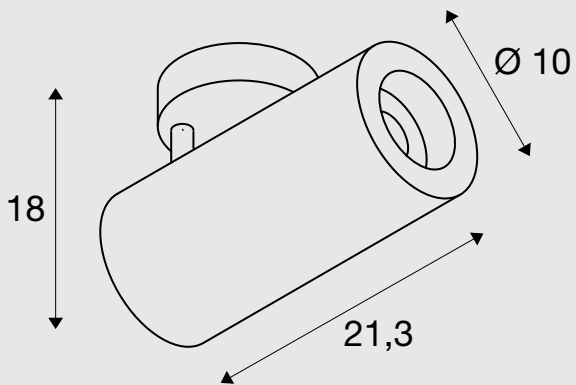

■ schwarz

Hinweis:

Zierring auch in weiß erhältlich



Zierring L □ weiß Art. Nr. 1006169

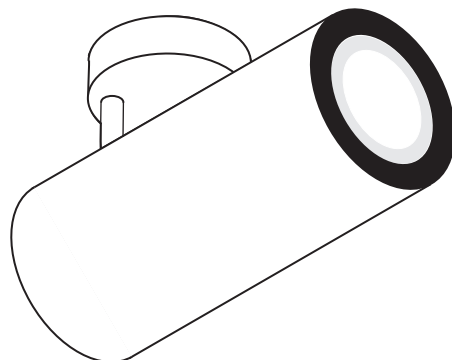

□ weiß



ART. NR.



			2440lm	24°	19	1004290
	2700K		2400lm	36°	19	1004291
			2475lm	60°	22	1004292
	3000K		2430lm	24°	13	1004298
			2340lm	36°	13	1004299
			2400lm	60°	22	1004300
	4000K		2675lm	24°	19	1004306
			2620lm	36°	19	1004307
			2715lm	60°	22	1004308



			2440lm	24°	19	1004578
	2700K		2400lm	36°	19	1004579
			2475lm	60°	22	1004580
	3000K		2430lm	24°	13	1004586
			2340lm	36°	13	1004587
			2400lm	60°	22	1004588
	4000K		2675lm	24°	19	1004594
			2620lm	36°	19	1004595
			2715lm	60°	22	1004596



			2440lm	24°	19	1004294
	2700K		2400lm	36°	19	1004295
			2475lm	60°	22	1004296
	3000K		2430lm	24°	13	1004302
			2340lm	36°	13	1004303
			2400lm	60°	22	1004304
	4000K		2675lm	24°	19	1004310
			2620lm	36°	19	1004311
			2715lm	60°	22	1004312



			2440lm	24°	19	1004582
	2700K		2400lm	36°	19	1004583
			2475lm	60°	22	1004584
	3000K		2430lm	24°	13	1004590
			2340lm	36°	13	1004591
			2400lm	60°	22	1004592
	4000K		2675lm	24°	19	1004598
			2620lm	36°	19	1004599
			2715lm	60°	22	1004600



NUMINOS® XL

NEW VARIANT



CL

Produktangaben:

220-240V ~50/60Hz | 900mA

Systemleistung: 36W

Material: Aluminium / Polycarbonat (PC)

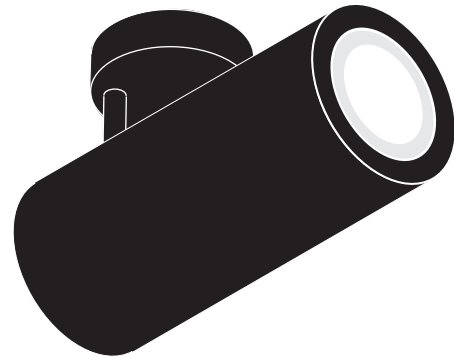
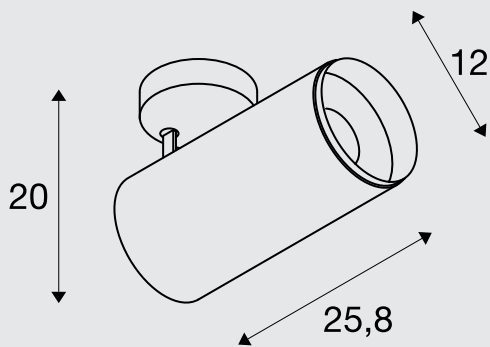

■ schwarz

Hinweis:

Zierring auch in weiß erhältlich



Zierring XL □ weiß Art. Nr. 1006170

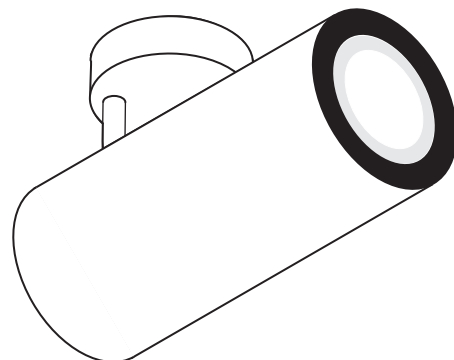

□ weiß



ART. NR.



			3290lm	24°	19	1006083
	2700K		3250lm	36°	19	1006084
			2980lm	60°	25	1006085
	3000K		3530lm	24°	19	1006089
			3490lm	36°	19	1006090
			3210lm	60°	25	1006091
	4000K		3800lm	24°	19	1006095
			3760lm	36°	19	1006096
			3460lm	60°	25	1006097



			3290lm	24°	19	1005741
	2700K		3250lm	36°	19	1005742
			2980lm	60°	25	1005743
	3000K		3530lm	24°	19	1005747
			3490lm	36°	19	1005748
			3210lm	60°	25	1005749
	4000K		3800lm	24°	19	1005753
			3760lm	36°	19	1005754
			3460lm	60°	25	1005755



			3290lm	24°	19	1006086
	2700K		3250lm	36°	19	1006087
			2980lm	60°	25	1006088
	3000K		3530lm	24°	19	1006092
			3490lm	36°	19	1006093
			3210lm	60°	25	1006094
	4000K		3800lm	24°	19	1006098
			3760lm	36°	19	1006099
			3460lm	60°	25	1006100



			3290lm	24°	19	1005744
	2700K		3250lm	36°	19	1005745
			2980lm	60°	25	1005746
	3000K		3530lm	24°	19	1005750
			3490lm	36°	19	1005751
			3210lm	60°	25	1005752
	4000K		3800lm	24°	19	1005756
			3760lm	36°	19	1005757
			3460lm	60°	25	1005758



NUMINOS® S



CL

Produktangaben:

220-240V ~50/60Hz | 250mA

Systemleistung: 11W

Material: Aluminium / Polycarbonat (PC)



L80B50

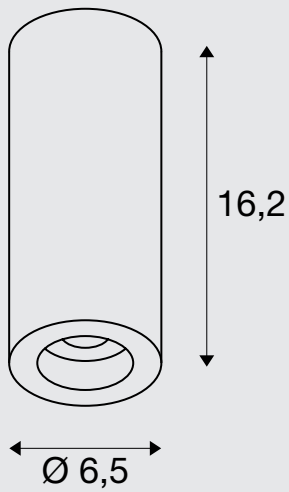

16,2

Ø 6,5



Hinweis:

Zierring auch in weiß erhältlich

Zierring S

□ weiß

Art. Nr. 1006167



■ schwarz

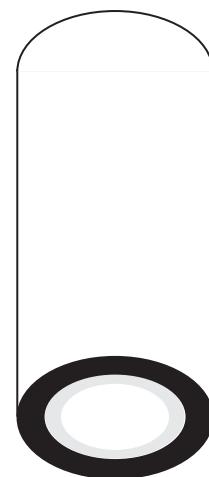

□ weiß



ART. NR.



			985lm	24°	16	1004122
	2700K		985lm	36°	16	1004123
			980lm	60°	19	1004124
	3000K		1020lm	24°	13	1004130
			1020lm	36°	13	1004131
			1020lm	60°	19	1004132
	4000K		1100lm	24°	16	1004138
			1100lm	36°	16	1004139
			1100lm	60°	19	1004140



			985lm	24°	16	1004410
	2700K		985lm	36°	16	1004411
			980lm	60°	19	1004412
	3000K		1020lm	24°	13	1004418
			1020lm	36°	13	1004419
			1020lm	60°	19	1004420
	4000K		1100lm	24°	16	1004426
			1100lm	36°	16	1004427
			1100lm	60°	19	1004428



			985lm	24°	16	1004126
	2700K		985lm	36°	16	1004127
			980lm	60°	19	1004128
	3000K		1020lm	24°	13	1004134
			1020lm	36°	13	1004135
			1020lm	60°	19	1004136
	4000K		1100lm	24°	16	1004142
			1100lm	36°	16	1004143
			1100lm	60°	19	1004144



			985lm	24°	16	1004414
	2700K		985lm	36°	16	1004415
			980lm	60°	19	1004416
	3000K		1020lm	24°	13	1004422
			1020lm	36°	13	1004423
			1020lm	60°	19	1004424
	4000K		1100lm	24°	16	1004430
			1100lm	36°	16	1004431
			1100lm	60°	19	1004432



NUMINOS® M



CL

Produktangaben:

220-240V ~50/60Hz | 500mA

Systemleistung: 20W

Material: Aluminium / Polycarbonat (PC)

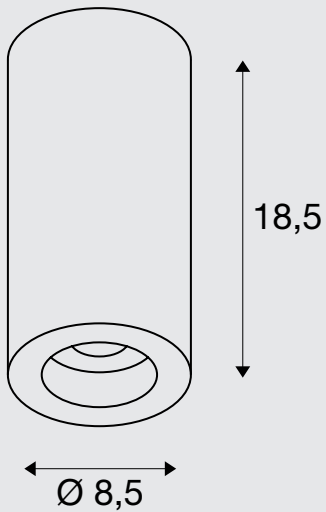

18,5

Ø 8,5



Hinweis:

Zierring auch in weiß erhältlich

Zierring M

weiß

Art. Nr. 1006168



schwarz



weiß



ART. NR.



			1925lm	24°	16	1004218
	2700K		1935lm	36°	16	1004219
			1885lm	60°	22	1004220
	3000K		1955lm	24°	16	1004226
			1970lm	36°	13	1004227
	4000K		1880lm	60°	22	1004228
			2125lm	24°	19	1004234
	4000K		2120lm	36°	16	1004235
			2060lm	60°	25	1004236



			1925lm	24°	16	1004506
	2700K		1935lm	36°	16	1004507
			1885lm	60°	22	1004508
	3000K		1955lm	24°	16	1004514
			1970lm	36°	13	1004515
	4000K		1880lm	60°	22	1004516
			2125lm	24°	19	1004522
	4000K		2120lm	36°	16	1004523
			2060lm	60°	25	1004524



			1925lm	24°	16	1004222
	2700K		1935lm	36°	16	1004223
			1885lm	60°	22	1004224
	3000K		1955lm	24°	16	1004230
			1970lm	36°	13	1004231
	4000K		1880lm	60°	22	1004232
			2125lm	24°	19	1004238
	4000K		2120lm	36°	16	1004239
			2060lm	60°	25	1004240



			1925lm	24°	16	1004510
	2700K		1935lm	36°	16	1004511
			1885lm	60°	22	1004512
	3000K		1955lm	24°	16	1004518
			1970lm	36°	13	1004519
	4000K		1880lm	60°	22	1004520
			2125lm	24°	19	1004526
	4000K		2120lm	36°	16	1004527
			2060lm	60°	25	1004528



NUMINOS® L



CL

Produktangaben:

220-240V ~50/60Hz | 700mA

Systemleistung: 28W

Material: Aluminium / Polycarbonat (PC)



L80B50

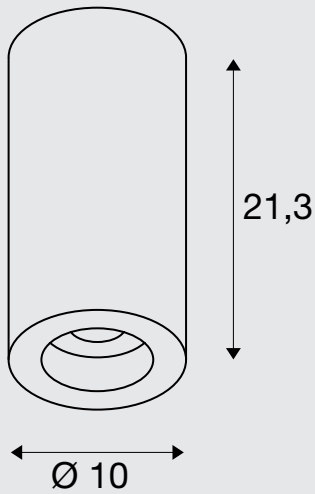

21,3

Ø 10



Hinweis:

Zierring auch in weiß erhältlich

Zierring L

weiß

Art. Nr. 1006169



schwarz

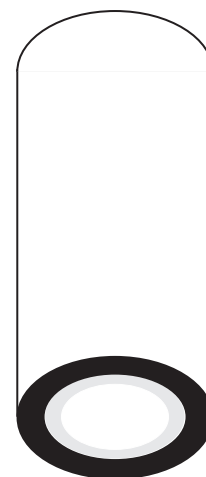

weiß



ART. NR.

		2700K	2440lm	24°	19	1004314	
			2400lm	36°	19	1004315	
			2475lm	60°	22	1004316	
		3000K	2430lm	24°	13	1004322	
			2340lm	36°	13	1004323	
			2400lm	60°	22	1004324	
		4000K	2675lm	24°	19	1004330	
			2620lm	36°	19	1004331	
		2715lm	60°	22	1004332		
		2700K	2440lm	24°	19	1004602	
			2400lm	36°	19	1004603	
			2475lm	60°	22	1004604	
		3000K	2430lm	24°	13	1004610	
			2340lm	36°	13	1004611	
			2400lm	60°	22	1004612	
		4000K	2675lm	24°	19	1004618	
			2620lm	36°	19	1004619	
		2715lm	60°	22	1004620		
		2700K	2440lm	24°	19	1004318	
			2400lm	36°	19	1004319	
			2475lm	60°	22	1004320	
		3000K	2430lm	24°	13	1004326	
			2340lm	36°	13	1004327	
			2400lm	60°	22	1004328	
		4000K	2675lm	24°	19	1004334	
			2620lm	36°	19	1004335	
		2715lm	60°	22	1004336		
		2700K	2440lm	24°	19	1004606	
			2400lm	36°	19	1004607	
			2475lm	60°	22	1004608	
		3000K	2430lm	24°	13	1004614	
			2340lm	36°	13	1004615	
			2400lm	60°	22	1004616	
		4000K	2675lm	24°	19	1004622	
			2620lm	36°	19	1004623	
		2715lm	60°	22	1004624		

NUMINOS® XL

NEW VARIANT



CL

Produktangaben:

220-240V ~50/60Hz | 900mA

Systemleistung: 36W

Material: Aluminium / Polycarbonat (PC)

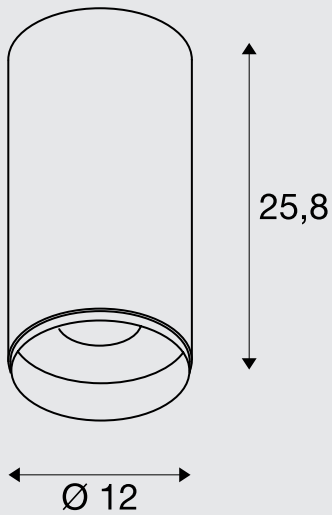

Hinweis:

Zierring auch in weiß erhältlich

Zierring XL

weiß

Art. Nr. 1006170



schwarz

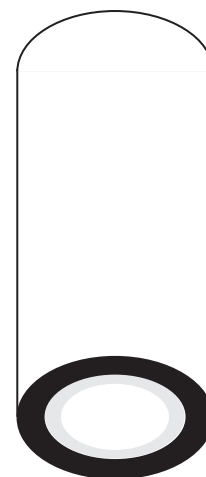

weiß



ART. NR.



Energy Class	Temp (K)	Flux (lm)	Beam (°)	UGR	Art. No.
		3290lm	24°	19	1005687
A F	2700K	3250lm	36°	19	1005688
		2980lm	60°	25	1005689
		3530lm	24°	19	1005693
A E	3000K	3490lm	36°	19	1005694
		3210lm	60°	25	1005695
		3800lm	24°	19	1005699
A E	4000K	3760lm	36°	19	1005700
		3460lm	60°	25	1005701



		3290lm	24°	19	1005759
A F	2700K	3250lm	36°	19	1005760
		2980lm	60°	25	1005761
		3530lm	24°	19	1005765
A E	3000K	3490lm	36°	19	1005766
		3210lm	60°	25	1005767
		3800lm	24°	19	1005771
A E	4000K	3760lm	36°	19	1005772
		3460lm	60°	25	1005773



		3290lm	24°	19	1005690
A F	2700K	3250lm	36°	19	1005691
		2980lm	60°	25	1005692
		3530lm	24°	19	1005696
A E	3000K	3490lm	36°	19	1005697
		3210lm	60°	25	1005698
		3800lm	24°	19	1005702
A E	4000K	3760lm	36°	19	1005703
		3460lm	60°	25	1005704



		3290lm	24°	19	1005762
A F	2700K	3250lm	36°	19	1005763
		2980lm	60°	25	1005764
		3530lm	24°	19	1005768
A E	3000K	3490lm	36°	19	1005769
		3210lm	60°	25	1005770
		3800lm	24°	19	1005774
A E	4000K	3760lm	36°	19	1005775
		3460lm	60°	25	1005776



NUMINOS® S



PD

Produktangaben:

220-240V ~50/60Hz | 250mA

Systemleistung: 11W

Material: Aluminium / Polycarbonat (PC)

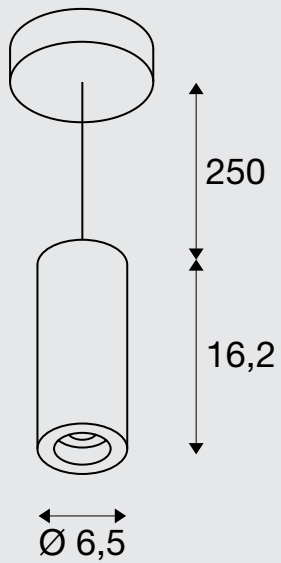
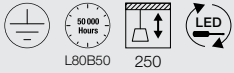

Hinweis:

Zierring auch in weiß erhältlich

Zierring S

□ weiß

Art. Nr. 1006167



■ schwarz

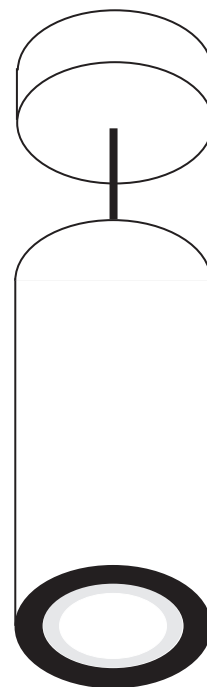

□ weiß



ART. NR.



			985lm	24°	16	1004146
	2700K		985lm	36°	16	1004147
			980lm	60°	19	1004148
	3000K		1020lm	24°	13	1004154
			1020lm	36°	13	1004155
			1020lm	60°	19	1004156
	4000K		1100lm	24°	16	1004162
			1100lm	36°	16	1004163
			1100lm	60°	19	1004164



			985lm	24°	16	1004434
	2700K		985lm	36°	16	1004435
			980lm	60°	19	1004436
	3000K		1020lm	24°	13	1004442
			1020lm	36°	13	1004443
			1020lm	60°	19	1004444
	4000K		1100lm	24°	16	1004450
			1100lm	36°	16	1004451
			1100lm	60°	19	1004452



			985lm	24°	16	1004150
	2700K		985lm	36°	16	1004151
			980lm	60°	19	1004152
	3000K		1020lm	24°	13	1004158
			1020lm	36°	13	1004159
			1020lm	60°	19	1004160
	4000K		1100lm	24°	16	1004166
			1100lm	36°	16	1004167
			1100lm	60°	19	1004168



			985lm	24°	16	1004438
	2700K		985lm	36°	16	1004439
			980lm	60°	19	1004440
	3000K		1020lm	24°	13	1004446
			1020lm	36°	13	1004447
			1020lm	60°	19	1004448
	4000K		1100lm	24°	16	1004454
			1100lm	36°	16	1004455
			1100lm	60°	19	1004456



NUMINOS® M



PD

Produktangaben:

220-240V ~50/60Hz | 500mA

Systemleistung: 20W

Material: Aluminium / Polycarbonat (PC)

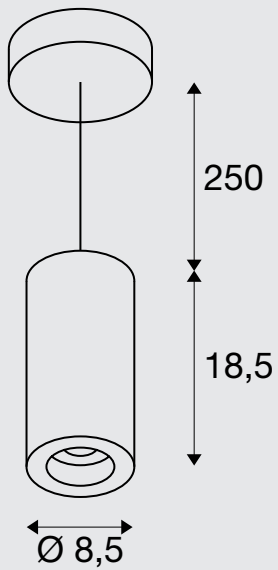
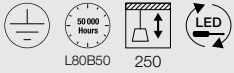

Hinweis:

Zierring auch in weiß erhältlich

Zierring M weiß Art. Nr. 1006168



schwarz

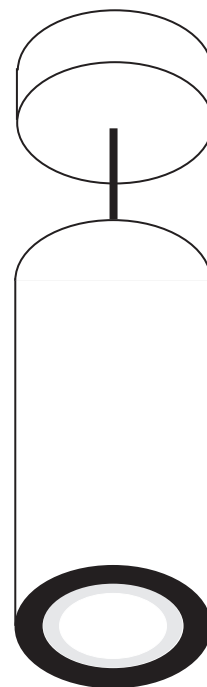

weiß



ART. NR.



	2700K	1925lm	24°	16	1004242
		1935lm	36°	16	1004243
		1885lm	60°	22	1004244
	3000K	1955lm	24°	16	1004250
		1970lm	36°	13	1004251
		1880lm	60°	22	1004252
	4000K	2125lm	24°	19	1004258
		2120lm	36°	16	1004259
		2060lm	60°	25	1004260



	2700K	1925lm	24°	16	1004530
		1935lm	36°	16	1004531
		1885lm	60°	22	1004532
	3000K	1955lm	24°	16	1004538
		1970lm	36°	13	1004539
		1880lm	60°	22	1004540
	4000K	2125lm	24°	19	1004546
		2120lm	36°	16	1004547
		2060lm	60°	25	1004548



	2700K	1925lm	24°	16	1004246
		1935lm	36°	16	1004247
		1885lm	60°	22	1004248
	3000K	1955lm	24°	16	1004254
		1970lm	36°	13	1004255
		1880lm	60°	22	1004256
	4000K	2125lm	24°	19	1004262
		2120lm	36°	16	1004263
		2060lm	60°	25	1004264



	2700K	1925lm	24°	16	1004534
		1935lm	36°	16	1004535
		1885lm	60°	22	1004536
	3000K	1955lm	24°	16	1004542
		1970lm	36°	13	1004543
		1880lm	60°	22	1004544
	4000K	2125lm	24°	19	1004550
		2120lm	36°	16	1004551
		2060lm	60°	25	1004552



NUMINOS® L



PD

Produktangaben:

220-240V ~50/60Hz | 700mA

Systemleistung: 28W

Material: Aluminium / Polycarbonat (PC)

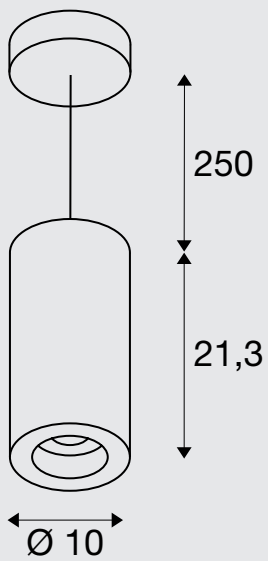
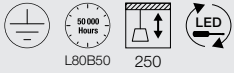

Hinweis:

Zierring auch in weiß erhältlich

Zierring L

weiß

Art. Nr. 1006169



schwarz

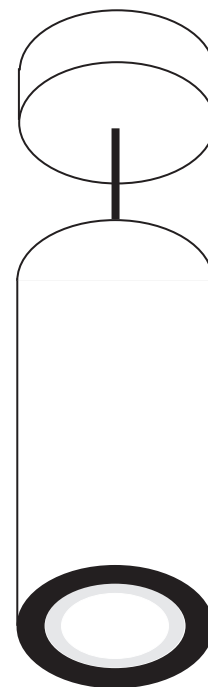

weiß



ART. NR.



			2440lm	24°	19	1004338
	2700K		2400lm	36°	19	1004339
			2475lm	60°	22	1004340
	3000K		2430lm	24°	13	1004346
			2340lm	36°	13	1004347
			2400lm	60°	22	1004348
	4000K		2675lm	24°	19	1004354
			2620lm	36°	19	1004355
			2715lm	60°	22	1004356



			2440lm	24°	19	1004626
	2700K		2400lm	36°	19	1004627
			2475lm	60°	22	1004628
	3000K		2430lm	24°	13	1004634
			2340lm	36°	13	1004635
			2400lm	60°	22	1004636
	4000K		2675lm	24°	19	1004642
			2620lm	36°	19	1004643
			2715lm	60°	22	1004644



			2440lm	24°	19	1004342
	2700K		2400lm	36°	19	1004343
			2475lm	60°	22	1004344
	3000K		2430lm	24°	13	1004350
			2340lm	36°	13	1004351
			2400lm	60°	22	1004352
	4000K		2675lm	24°	19	1004358
			2620lm	36°	19	1004359
			2715lm	60°	22	1004360



			2440lm	24°	19	1004630
	2700K		2400lm	36°	19	1004631
			2475lm	60°	22	1004632
	3000K		2430lm	24°	13	1004638
			2340lm	36°	13	1004639
			2400lm	60°	22	1004640
	4000K		2675lm	24°	19	1004646
			2620lm	36°	19	1004647
			2715lm	60°	22	1004648



NUMINOS® XL

NEW VARIANT



PD

Produktangaben:

220-240V ~50/60Hz | 900mA

Systemleistung: 36W

Material: Aluminium / Polycarbonat (PC)

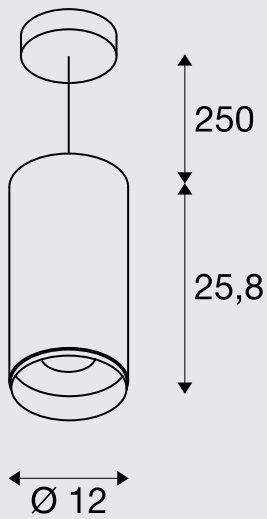
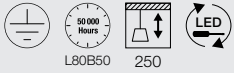

Hinweis:

Zierring auch in weiß erhältlich

Zierring XL

weiß

Art. Nr. 1006170



schwarz

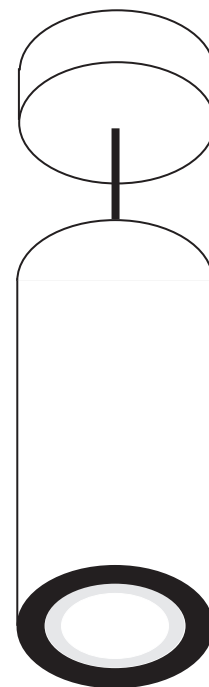

weiß



ART. NR.



			3290lm	24°	19	1005705
	2700K		3250lm	36°	19	1005706
			2980lm	60°	25	1005707
			3530lm	24°	19	1005711
	3000K		3490lm	36°	19	1005712
			3210lm	60°	25	1005713
			3800lm	24°	19	1005717
	4000K		3760lm	36°	19	1005718
			3460lm	60°	25	1005719
			3290lm	24°	19	1005777
	2700K		3250lm	36°	19	1005778
			2980lm	60°	25	1005779
			3530lm	24°	19	1005783
	3000K		3490lm	36°	19	1005784
			3210lm	60°	25	1005785
			3800lm	24°	19	1005789
	4000K		3760lm	36°	19	1005790
			3460lm	60°	25	1005791
			3290lm	24°	19	1005708
	2700K		3250lm	36°	19	1005709
			2980lm	60°	25	1005710
			3530lm	24°	19	1005714
	3000K		3490lm	36°	19	1005715
			3210lm	60°	25	1005716
			3800lm	24°	19	1005720
	4000K		3760lm	36°	19	1005721
			3460lm	60°	25	1005722
			3290lm	24°	19	1005780
	2700K		3250lm	36°	19	1005781
			2980lm	60°	25	1005782
			3530lm	24°	19	1005786
	3000K		3490lm	36°	19	1005787
			3210lm	60°	25	1005788
			3800lm	24°	19	1005792
	4000K		3760lm	36°	19	1005793
			3460lm	60°	25	1005794





ZEITLOSE KLASSIKER

PASSENDE TISCH- UND STANDLEUCHTEN
FÜR JEDEN RAUM.

Die Klassiker unter den Leuchten: Unsere Tisch- und Standleuchten fügen sich dank ihres schlichten und schlanken Designs in jedes Interieur ein und machen so im Büro, Wohnraum oder Ladengeschäft einfach immer eine gute Figur.





155540 + 155592 105 + 107



1002146 109



1003029 + 1000764 99 + 107

TISCH- UND STANDLEUCHTEN



Weitere Leuchten und Varianten finden Sie online unter www.slv.com
 Herstellerangaben unserer Leuchtmittlempfehlungen finden Sie Im Kapitel Leuchtmittel ab Seite 808

WORKLIGHT
TL



WORKLIGHT
TL



NEW



NEW

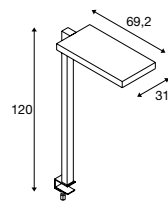
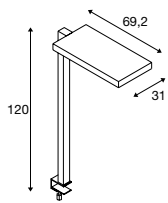
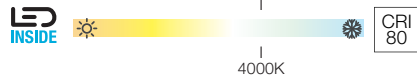
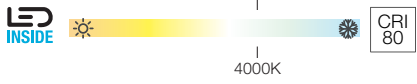

200-240V ~50/60Hz | 2000mA
Systemleistung: 79W
Material: Aluminium

200-240V ~50/60Hz | 2000mA
Systemleistung: 79W
Material: Aluminium

- Eurostecker
- Klemmbereich: 6-40 mm

- Eurostecker
- Klemmbereich: 6-40 mm

Up/Down	3800lm 4000K	

Up/Down	3800lm 4000K	

Variante	Art. Nr.
Up: 3800lm 4000K CRI80 Down: 3800lm 4000K CRI80	1005392
■ schwarz	■

Variante	Art. Nr.
Up: 3800lm 4000K CRI80 Down: 3800lm 4000K CRI80	1005394
□ weiß	■





1005392 100



1005390 101

WORKLIGHT
FL



NEW

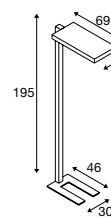
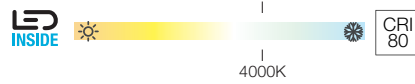

200-240V ~50/60Hz | 2000mA
Systemleistung: 79W
Material: Aluminium

- Eurostecker



Up/Down	3800lm 4000K	

Variante Art. Nr.

Up: 3800lm | 4000K | CRI80
Down: 3800lm | 4000K | CRI80

■ schwarz 1005392 ■

WORKLIGHT
FL



NEW

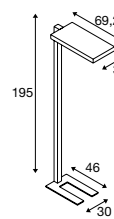
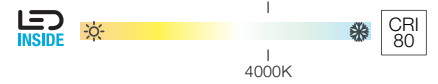

200-240V ~50/60Hz | 2000mA
Systemleistung: 79W
Material: Aluminium

- Eurostecker



Up/Down	3800lm 4000K	

Variante Art. Nr.

Up: 3800lm | 4000K | CRI80
Down: 3800lm | 4000K | CRI80

□ weiß 1005391 ■



SLV FENDA. MIX & MATCH.

MIX & MATCH Video

bit.ly/slv-mix-match



1003031 + 1004775 104 + 107



1003029 + 100763 99 + 106



1004773 + 155780 155 + 104

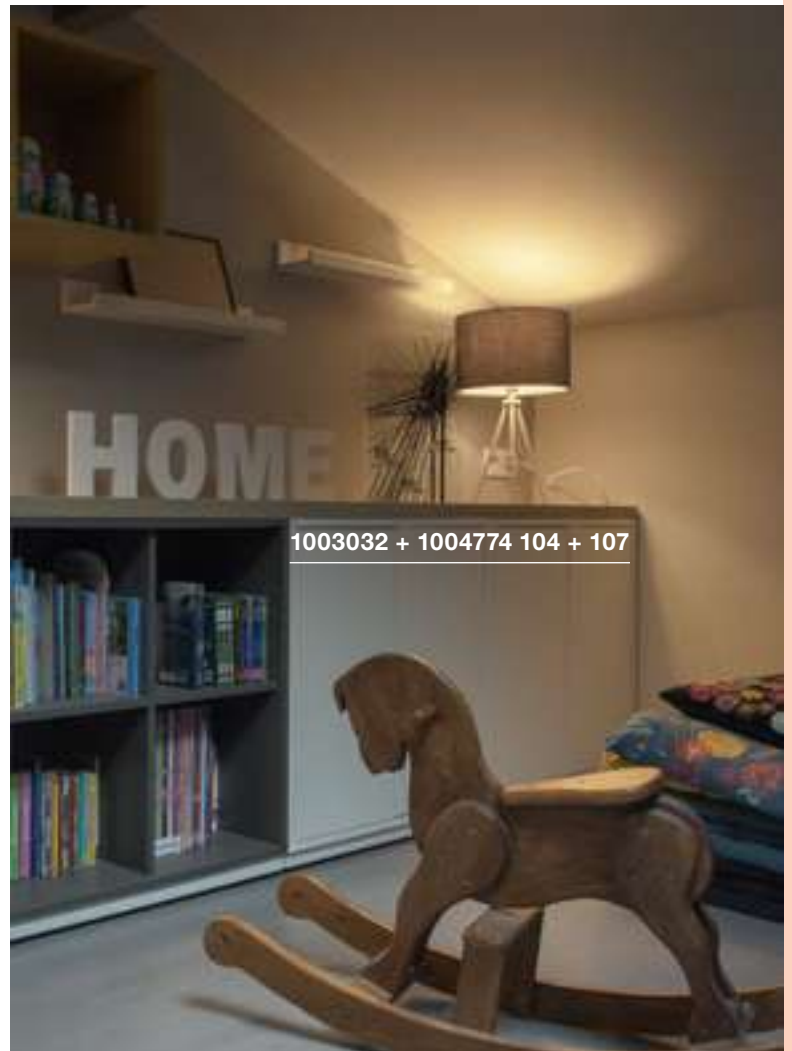

1003032 + 1004774 104 + 107

FENDA
TL, E27

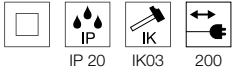
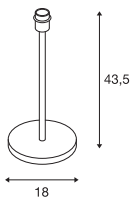

220-240V ~50/60Hz
Material: Stahl

- Eurostecker und Schalter



E27 <60W



LED E27 | 7,5W | 320°
2700K | 700lm | EEK=F
8kWh/1000h



Art. Nr. 1005304

Variante	Art. Nr.
1xE27 ■ schwarz	155780
1xE27 □ weiß	1003030 ▼
1xE27 ■ metall	155785

FENDA
FL, E27

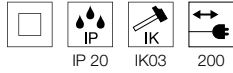
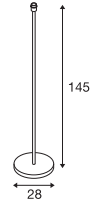

220-240V ~50/60Hz
Material: Stahl

- Eurostecker und Schalter



E27 <60W



LED E27 | 9W | 220°
2700K | 800lm | EEK=F
9kWh/1000h



Art. Nr. 1005301

Variante	Art. Nr.
1xE27 ■ schwarz	155790
1xE27 □ weiß	1003031 ▼
1xE27 ■ metall	155795

1003030 + 1004773 104 + 107



155790 + 156110 104 + 107





155540 + 155592 105 + 107

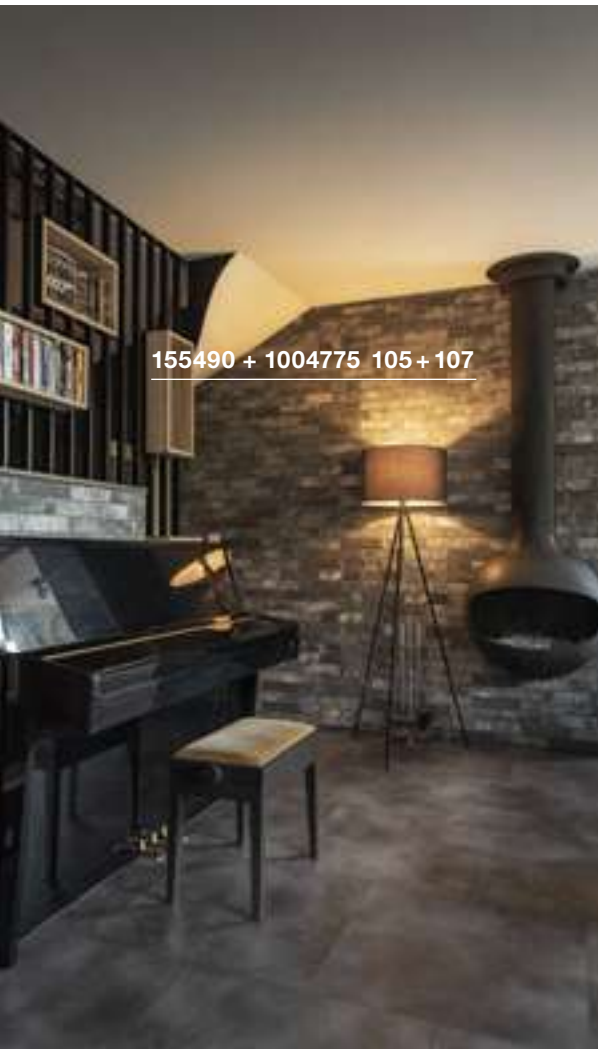

155490 + 1004775 105 + 107

FENDA
TL, E27

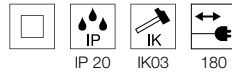
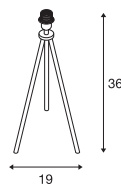

220-240V ~50/60Hz
Material: Aluminium

- Eurostecker



E27 <40W



LED E27 | 7,5W | 320°
2500K | 700lm | EEK=F
8kWh/1000h



Art. Nr. 1005265

Variante	Art. Nr.
1xE27	
■ schwarz	155540
1xE27	
□ weiß	1003032 ▼

FENDA
FL, E27

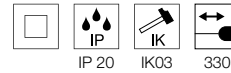
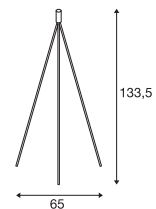

220-240V ~50/60Hz
Material: Aluminium

- Eurostecker



E27 <40W



LED E27 | 13,2W | 220°
2700K | 1300lm | EEK=F
13kWh/1000h



Art. Nr. 1005302

Variante	Art. Nr.
1xE27	
■ schwarz	155490
1xE27	
□ weiß	1003033 ▼
1xE27	
■ chrom	155492 ▼

FENDA BOW BASIS
FL, E27



SOCKET INSIDE <25 W

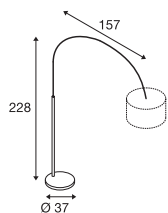

220-240V ~50/60Hz
Material: Stahl

- max. zulässiges Schirmgewicht 900g
- Eurostecker und Schalter



E27 <25W L: 17,5 cm



LED E27 | 7,5W | 320°
2700K | 700lm | EEK=F
8kWh/1000h



Art. Nr. 1005304

Variante	Art. Nr.
1xE27	
■ schwarz	1003029
1xE27	
□ weiß	1003028 ▼
1xE27	
■ chrom	1000763



1003028 + 156111 106 + 107

FENDA
15 cm, rund

NEW VARIANT

H: 40 cm
Ø: 15 cm
Material: Textil / Stahl

Variante	Art. Nr.
■ schwarz / kupfer	156152
□ weiß	156141
■ beige	156143
■ grau	1004773

FENDA
30 cm, rund

NEW VARIANT

H: 20 cm
Ø: 30 cm
Material: Textil / Stahl

Variante	Art. Nr.
■ schwarz / kupfer	155592
□ weiß	155582
■ beige	155583
■ grau	1004774

FENDA
45 cm, rund

NEW VARIANT

H: 28 cm
Ø: 45,5 cm
Material: Textil / Stahl

Variante	Art. Nr.
■ schwarz / kupfer	156122
□ weiß	156111
■ beige	156113
■ grau	1004775

FENDA
Ø 70 cm, rund

IP 20

H: 36 cm
Ø: 70 cm
Material: Textil / Stahl

- max. 20W

Variante	Art. Nr.
■ schwarz / kupfer	1000580
□ weiß	1000579

FENDA
Ø 40 cm, rund

IP 20

H: 30 cm
Ø: 40 cm
Material: Polymethylacrylat (PMMA)

- max. 40W

Variante	Art. Nr.
□ weiß	1000764



KARPO TL



KARPO FL

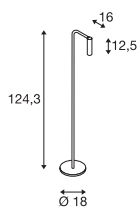
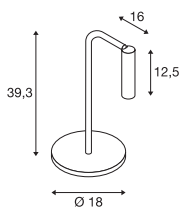
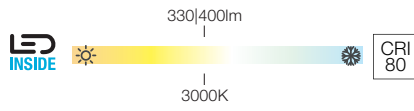
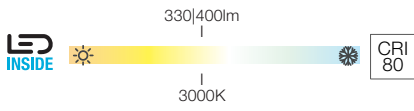

230

230

100-240V ~50/60Hz | 500mA
Systemleistung: 6,5W
Material: Aluminium

100-240V ~50/60Hz | 500mA
Systemleistung: 6,5W
Material: Aluminium

- Steckernetzteil

- Steckernetzteil

1001461, 1001460	330lm/400lm 3000K	

1001463, 1001462	330lm/400lm 3000K	

Variante	Art. Nr.
330lm 3000K CRI80	
■ schwarz	1001461
400lm 3000K CRI90	
□ weiß	1001460

Variante	Art. Nr.
330lm 3000K CRI80	
■ schwarz	1001463
400lm 3000K CRI90	
□ weiß	1001462



1001461 108



1001463 108



1001676 109



1002146 109

FITU
TL, E27



FITU
FL, E27

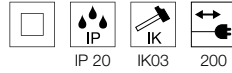
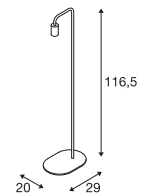
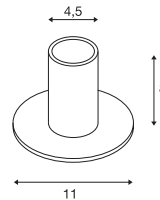
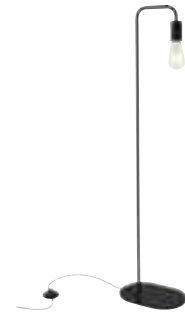

220-240V ~50/60Hz
Material: Aluminium

- Eurostecker und Schalter

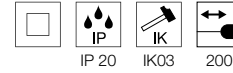

220-240V ~50/60Hz
Material: Aluminium / Stahl

- Eurostecker und Schalter



E27 <10W



LED E27 | 7,5W | 320°
2500K | 700lm | EEK=F
8kWh/1000h



Art. Nr. 1005265

Variante	Art. Nr.
1xE27 ■ schwarz	1001676

Variante	Art. Nr.
1xE27 ■ schwarz	1002146



PHELIA
TL, QPAR51

PHELIA
FL, E27

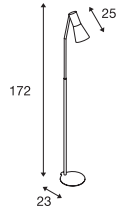
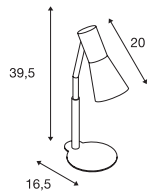

230V ~50/60Hz
Material: Aluminium / Stahl

- Schutzkontaktstecker und Schalter

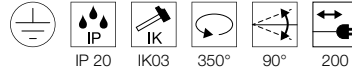

230V ~50/60Hz
Material: Aluminium / Stahl

- Schutzkontaktstecker und Schalter



GU10 <35W
Ø: 5 cm L: 10,5 cm



LED GU10 | 3,2W
2700K | 270lm | EEK=G
4kWh/1000h



Art. Nr. 1003101

Variante	Art. Nr.
1xGU10 ■ schwarz	146000

Variante	Art. Nr.
1xE27 ■ schwarz	146010



146000 110



146010 110



1002404 111



1002405 111

MECANICA PLUS TL



MECANICA PLUS FL

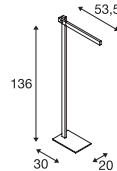
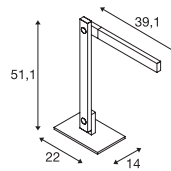
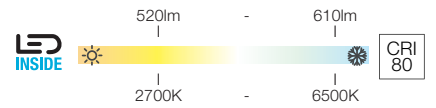
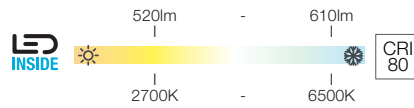
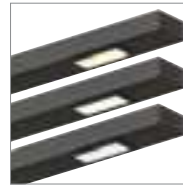

220-240V ~50/60Hz | 12V
 Systemleistung: 7,9W
 Material: Aluminium

- Steckernetzteil



220-240V ~50/60Hz | 12V
 Systemleistung: 7,9W
 Material: Aluminium

- Steckernetzteil



1002404	520-610lm 2700-6500K	



1002405	520-610lm 2700-6500K	

Variante	Art. Nr.
520-610lm 2700-6500K CRI80	
■ schwarz	1002404

Variante	Art. Nr.
520-610lm 2700-6500K CRI80	
■ schwarz	1002405

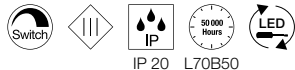
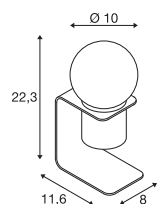
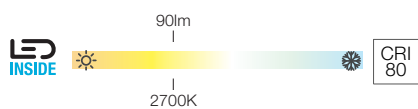
TONILA
TL

5V Batteriebetrieb
Systemleistung: 1,6W
Material: Aluminium / Kunststoff

- Batterie 3.6V 2000mAh inkl.
- Netzteil exkl. USB Ladegerät 5V DC/1-2A benötigt
- Für MINI-USB Ladekabel
- Durch Taster in 3 Stufen dimmbar



1002583	90lm 2700K	

Variante	Art. Nr.
90lm 2700K CRI80 ■ schwarz	1002583

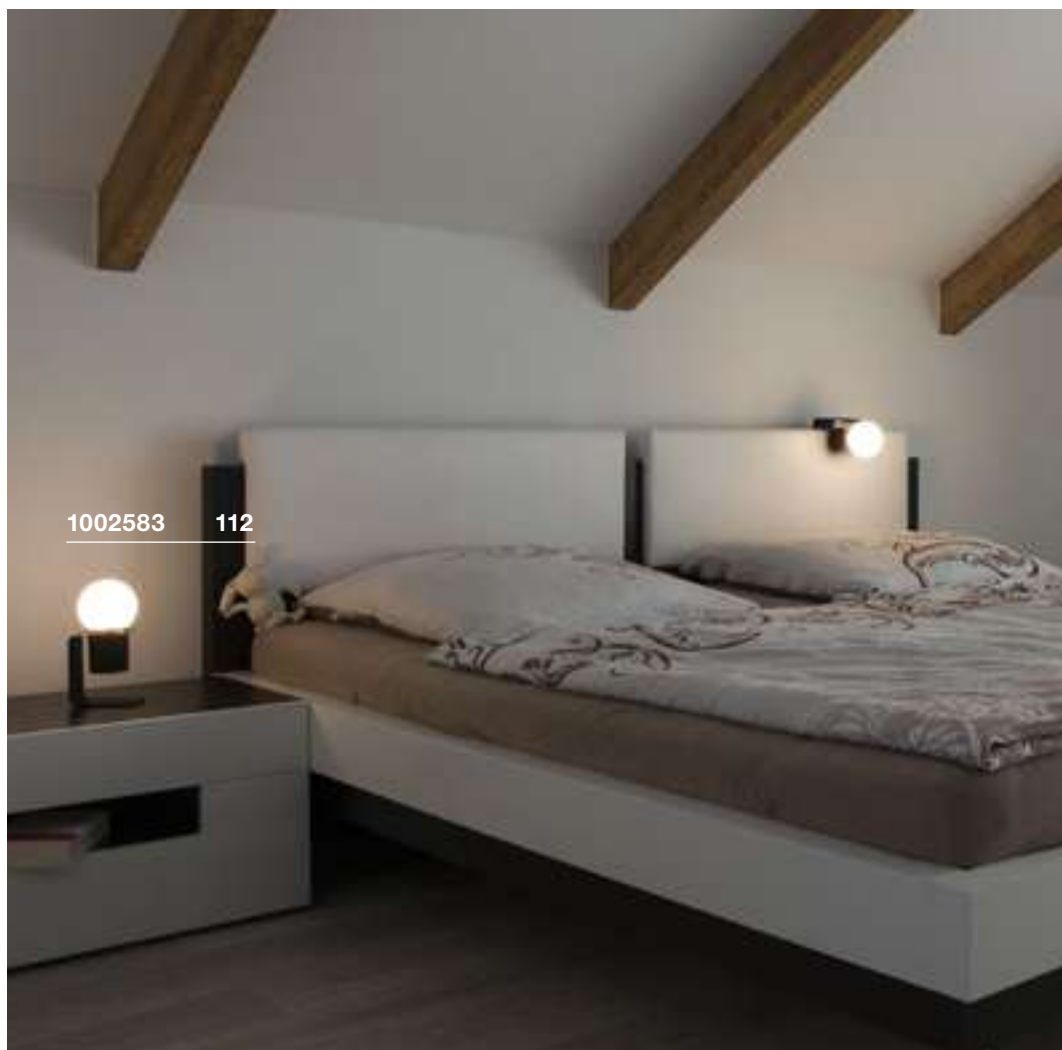



1004970 113

MAGANDA
TL

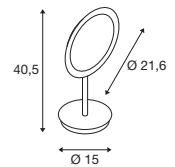
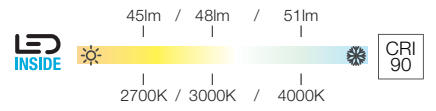

	IP 44	IK02	L70B50	340°	90°	200

100-240V ~50/60Hz | 12V
Systemleistung: 4,8W
Material: Stahl / Glas

- Schutzkontaktstecker
- Farbtemperatur durch Taster in 3 Stufen wählbar



1004970	45/48/51lm 2700/3000/4000K	

Variante	Art. Nr.
45/48/51lm 2700/3000/4000K CRI90 ■ chrom / gefrosted	1004970

DA BLEIBEN BLICKE HÄNGEN.

PENDELLEUCHTEN SETZEN AKZENTE.

Geben Sie jedem Raum eine individuelle Note: Mit Pendelleuchten tauchen Sie ausgewählte Bereiche in atmosphärisches Licht und setzen, dank verschiedenster Stilrichtungen, optische Highlights. Ob in Restaurants, Cafés, Bars oder zuhause – die Leuchten schaffen Orte der Gemütlichkeit und setzen geschmackvolle Statements.





135120

131

Pendelleuchten aus dem NUMINOS® Down- und Spotlightsystem finden Sie auf den Seiten 88 bis 95. Oder ganz einfach online konfigurieren unter: www.numinos.slv.com

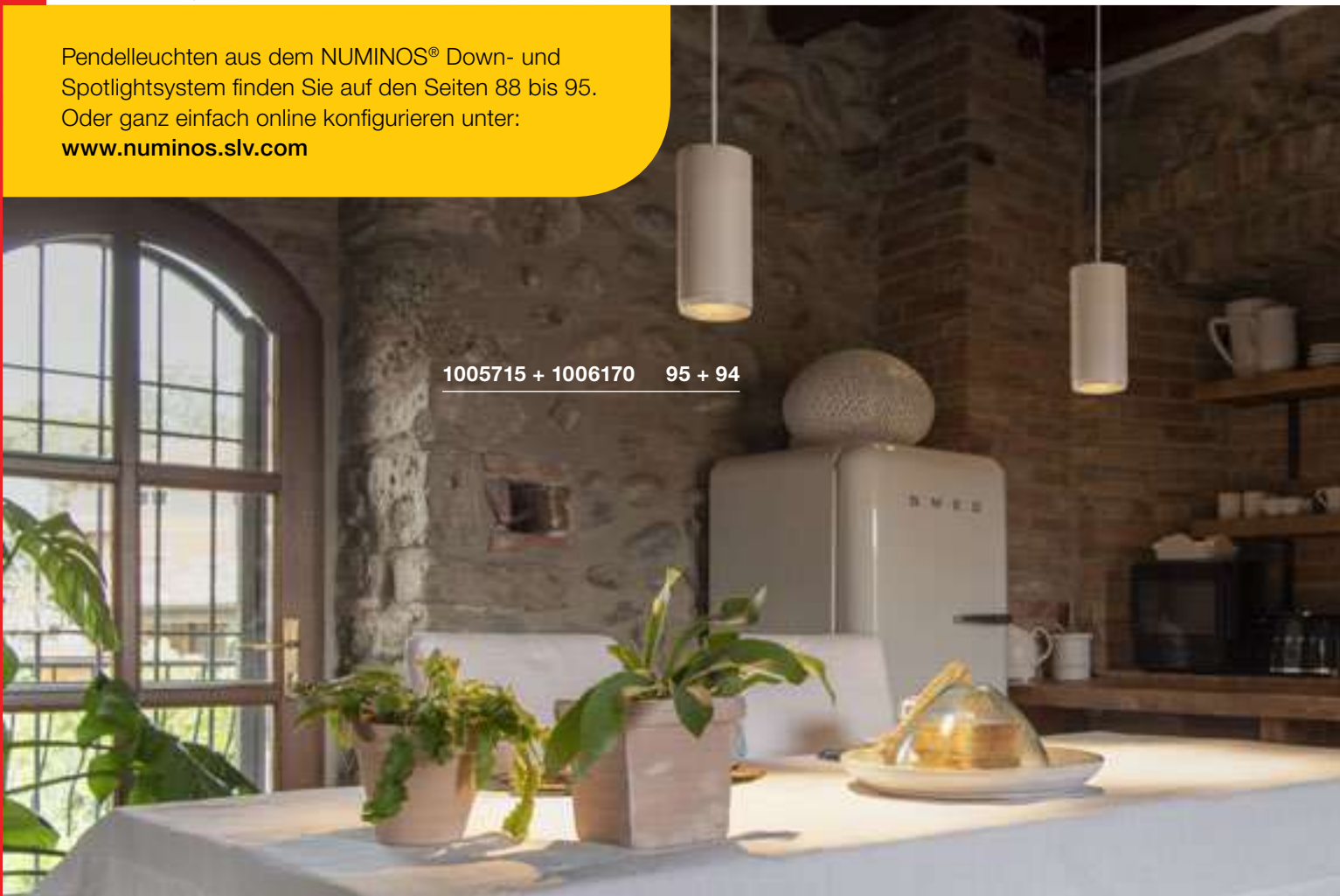

1005715 + 1006170 95 + 94

PENDELLEUCHTEN

NEW 118	NEW 118	 119	 120	 120	 121	NEW VARIANT 121	 122
 123	NEW VARIANT 123	 128	 128	 129	 130	 131	 131
 131	 132	 133	 133	 134	 134	 134	 135
 136	 136	 136	 137	 138	 139	 140	 140
 141	 141	 142	 143	 143	 144	 144	 145

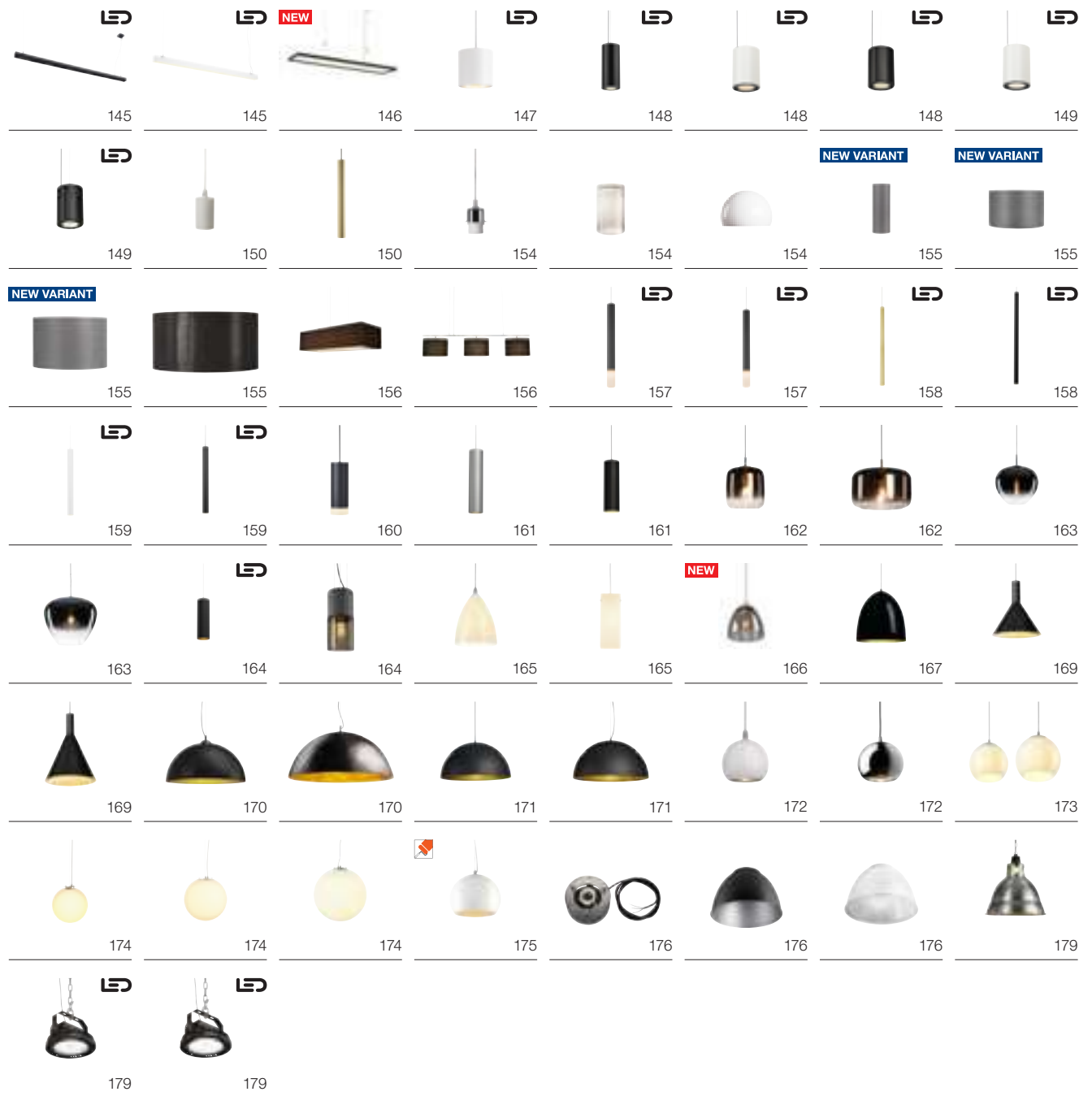

Weitere Leuchten und Varianten finden Sie online unter www.slv.com
 Herstellerangaben unserer Leuchtmittlempfehlungen finden Sie im Kapitel Leuchtmittel ab Seite 808

ONE LINEAR 100
PD, PHASE, up/down



NEW

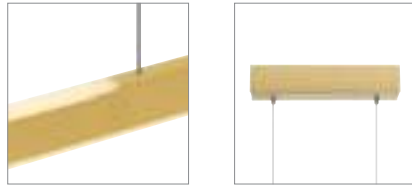
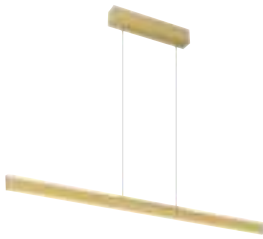

1250lm / 1950lm

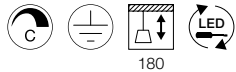
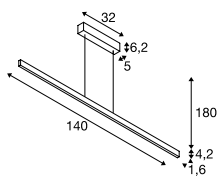
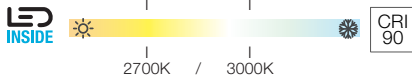

180

220-240V ~50/60Hz | 600mA
Systemleistung: 24W
Material: Aluminium / Stahl

ONE LINEAR 140
PD, PHASE, up/down



NEW

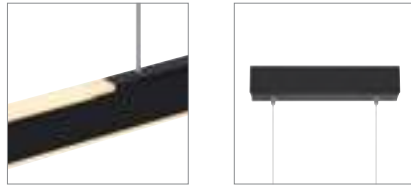

1810lm / 2855lm

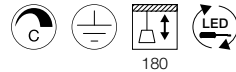
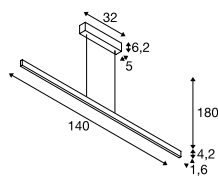
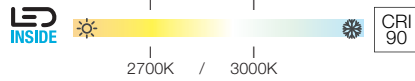

180

220-240V ~50/60Hz | 900mA
Systemleistung: 35W
Material: Aluminium / Stahl



1006187 118



	Light Spectrum	A → G
Up	550/580lm 2700/3000K	A ↑ G ↓ F
Down	670/700lm 2700/3000K	A ↑ G ↓ F

Variante	Art. Nr.
Up: 550/580lm 2700/3000K CRI90 Down: 700/670lm 2700/3000K CRI90	■ schwarz 1006185
Up: 550/580lm 2700/3000K CRI90 Down: 700/670lm 2700/3000K CRI90	□ weiß 1006186
Up: 550/580lm 2700/3000K CRI90 Down: 700/670lm 2700/3000K CRI90	■ messing 1006187



	Light Spectrum	A → G
Up	830/860lm 2700/3000K	A ↑ G ↓ F
Down	980/1015lm 2700/3000K	A ↑ G ↓ F

Variante	Art. Nr.
Up: 830/860lm 2700/3000K CRI90 Down: 980/1015lm 2700/3000K CRI90	■ schwarz 1006188
Up: 830/860lm 2700/3000K CRI90 Down: 980/1015lm 2700/3000K CRI90	□ weiß 1006189
Up: 830/860lm 2700/3000K CRI90 Down: 980/1015lm 2700/3000K CRI90	■ messing 1006190

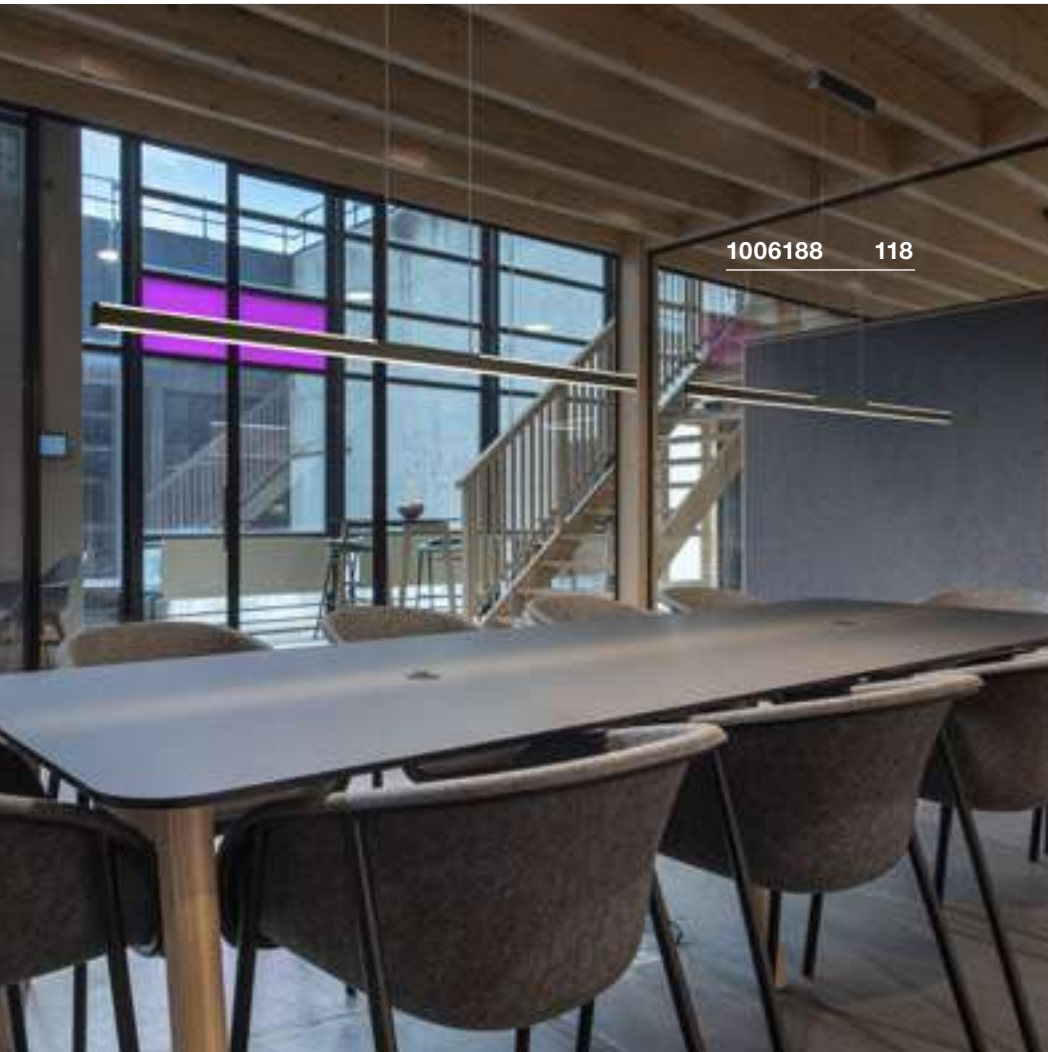

1006188 118

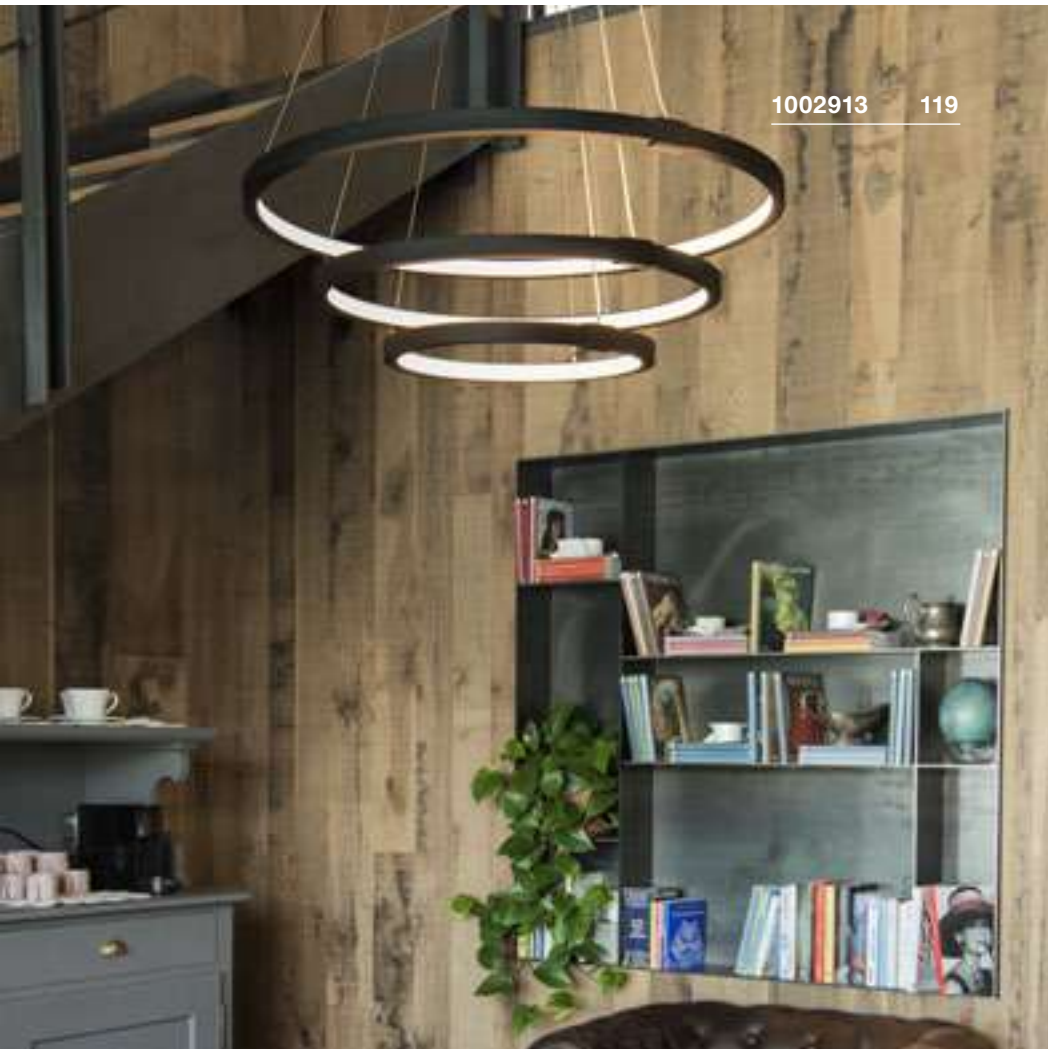

1002913 119

ONE TRIPLE
PD, DALI

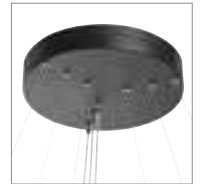

4040lm / 4200lm

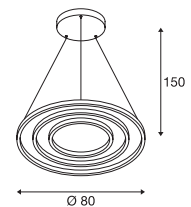

IP 20 L70B50 3000

220-240V ~50/60Hz | 1700mA
Systemleistung: 64W
Material: Aluminium / Stahl



1002913, 1002914	4040/4200lm 3000/4000K	

Variante	Art. Nr.
4040/4200lm 3000/4000K CRI90	
■ schwarz	1002913
4040/4200lm 3000/4000K CRI90	
□ weiß	1002914

ONE 60
PD, DALI

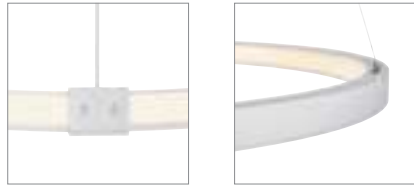

1480lm / 1550lm

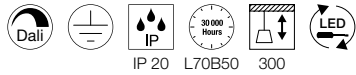
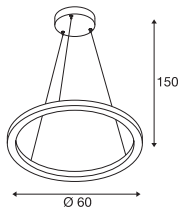
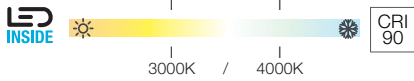

220-240V ~50/60Hz | 600mA
Systemleistung: 24W
Material: Aluminium / Stahl

ONE 80
PD, DALI

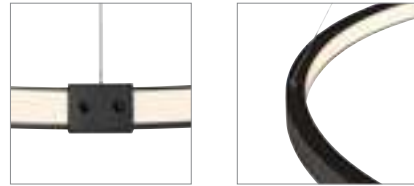

1930lm / 2140lm

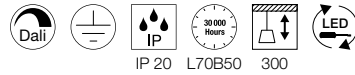
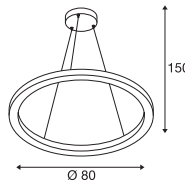

220-240V ~50/60Hz | 800mA
Systemleistung: 32W
Material: Aluminium / Stahl



1002911 120



1002912 120



1002909, 1002910	1480/1550lm 3000/4000K	

Variante	Art. Nr.
1480/1550lm 3000/4000K CRI90	
■ schwarz	1002909
1480/1550lm 3000/4000K CRI90	
□ weiß	1002910



1002911, 1002912	1930/2140lm 3000/4000K	

Variante	Art. Nr.
1930/2140lm 3000/4000K CRI90	
■ schwarz	1002911
1930/2140lm 3000/4000K CRI90	
□ weiß	1002912



1004759 121

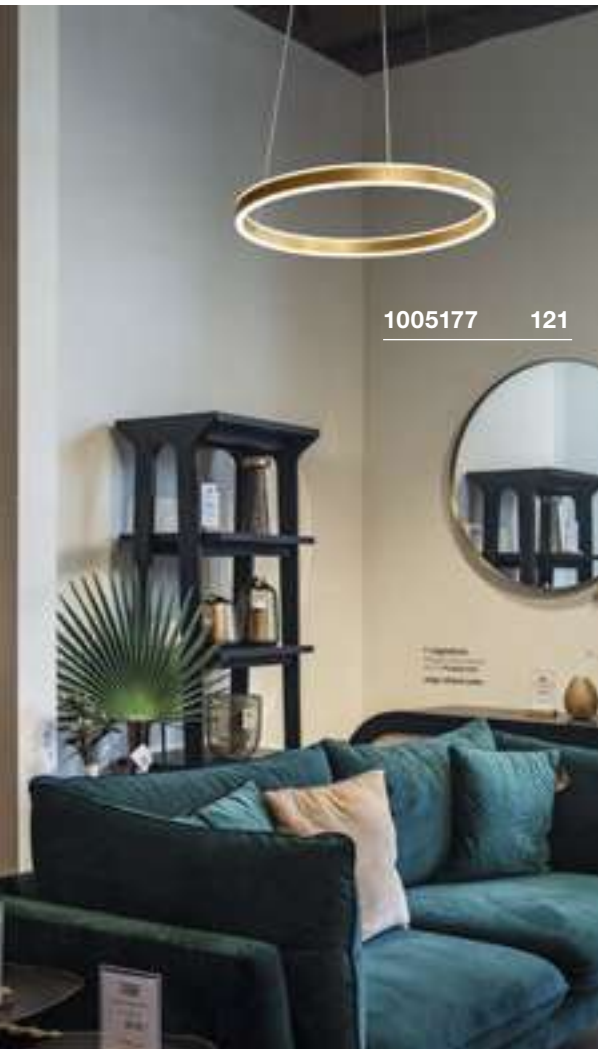

1005177 121

ONE 60
PD, DALI, up/down

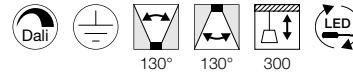
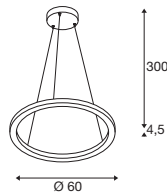
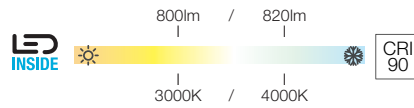

220-240V ~50/60Hz | 600mA
Systemleistung: 25W
Material: Aluminium / Stahl



Up/Down	400/410lm 3000/4000K	

Variante	Art. Nr.
Up: 400/410lm 3000/4000K CRI90 Down: 400/410lm 3000/4000K CRI90	
■ schwarz	1004761
Up: 400/410lm 3000/4000K CRI90 Down: 400/410lm 3000/4000K CRI90	
□ weiß	1004762

ONE 60
PD, PHASE, up/down



NEW VARIANT

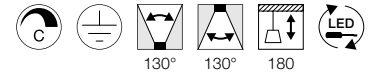
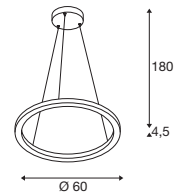
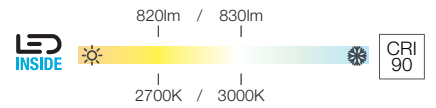

220-240V ~50/60Hz | 600mA
Systemleistung: 24W
Material: Aluminium / Stahl



Up/Down	410/415lm 2700/3000K	

Variante	Art. Nr.
Up: 410/415lm 2700/3000K CRI90 Down: 410/415lm 2700/3000K CRI90	
■ schwarz	1004759
Up: 410/415lm 2700/3000K CRI90 Down: 410/415lm 2700/3000K CRI90	
□ weiß	1004760
Up: 410/415lm 2700/3000K CRI90 Down: 410/415lm 2700/3000K CRI90	
■ messing	1005177

ONE 80
PD, DALI, up/down



1230lm / 1270lm

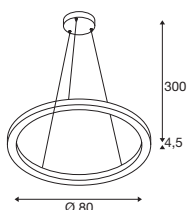

220-240V ~50/60Hz | 800mA
Systemleistung: 34W
Material: Aluminium / Stahl



Up/Down	615/635lm 3000/4000K	

Variante	Art. Nr.
Up: 615/635lm 3000/4000K CRI90 Down: 615/635lm 3000/4000K CRI90	
■ schwarz	1004763
Up: 615/635lm 3000/4000K CRI90 Down: 615/635lm 3000/4000K CRI90	
□ weiß	1004764



1004764 122



1004767 123

ONE DOUBLE PD, DALI, up/down

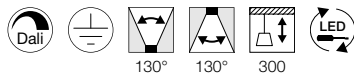
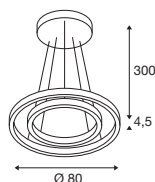
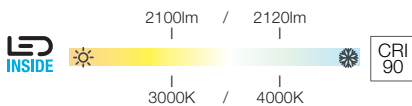

220-240V ~50/60Hz | 1400mA
Systemleistung: 55W
Material: Aluminium / Stahl

ONE DOUBLE PD, PHASE, up/down



NEW VARIANT

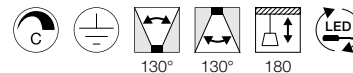
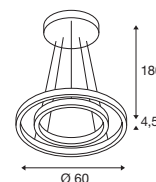
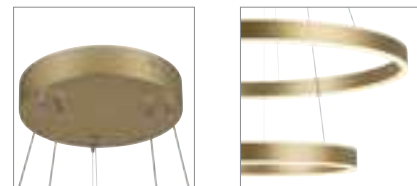

220-240V ~50/60Hz | 900mA
Systemleistung: 35W
Material: Aluminium / Stahl



1005178 123



Up/Down	1050/1060lm 3000/4000K	

Variante	Art. Nr.
Up: 1050/1060lm 3000/4000K CRI90 Down: 1050/1060lm 3000/4000K CRI90	
■ schwarz	1004767
Up: 1050/1060lm 3000/4000K CRI90 Down: 1050/1060lm 3000/4000K CRI90	
□ weiß	1004768



Up/Down	615/635lm 2700/3000K	

Variante	Art. Nr.
Up: 615/635lm 2700/3000K CRI90 Down: 615/635lm 2700/3000K CRI90	
■ schwarz	1004765
Up: 615/635lm 2700/3000K CRI90 Down: 615/635lm 2700/3000K CRI90	
□ weiß	1004766
Up: 615/635lm 2700/3000K CRI90 Down: 615/635lm 2700/3000K CRI90	
■ messing	1005178







MEDO LEUCHTENFAMILIE.

PENDEL- ODER DECKENLEUCHE.

	MEDO 30 CL, 1-10V	MEDO 40 CL, 1-10V	MEDO 60 CL, 1-10V	MEDO 90 CL, 1-10V
Beispiel				
Leuchtmittel				
Größe	Ø: 30 cm	Ø: 40 cm	Ø: 60 cm	Ø: 90 cm
Lichtstärke	1000lm	2000lm	3500lm	11000lm
UGR	25	25	22	25
Dimmbar	1-10V	1-10V	1-10V	1-10V
Abhängeset (exkl.)	1,5 m 5 m	1,5 m 5 m	1,5 m 5 m	1,5 m 5 m

	MEDO 30 CL, PHASE	MEDO 40 CL, PHASE	
Beispiel			
Leuchtmittel			
Größe-Ø	Ø: 30 cm	Ø: 40 cm	
Lichtstärke	1200lm	2125lm	
UGR	25	25	
Dimmbar	C, L	C, L	
Abhängeset (exkl.)	1,5 m 5 m	1,5 m 5 m	





















	MEDO 60 CL, quadratisch, 1-10V	MEDO 60 CL, quadratisch, DALI	
Beispiel			
Leuchtmittel			
Größe	B L: 60 cm	B L: 60 cm	
Lichtstärke	3300 lm	3300 lm	
UGR	22	22	
Dimmbar	1-10V		
Abhängeset (exkl.)	1,5 m 5 m	1,5 m 5 m	

	MEDO RING 60 PD, 1-10V	MEDO RING 90 PD, 1-10V	MEDO RING 60 PD, DALI
Beispiel			
Leuchtmittel			
Größe	Ø: 60 cm	Ø: 90 cm	Ø: 60 cm
Lichtstärke	2000lm	3945lm	2000lm
UGR	-	-	22
Dimmbar	1-10V	1-10V	
Abhängeset	nicht nötig, (inkl.) – reine Pendelleuchte	nicht nötig, (inkl.) – reine Pendelleuchte	nicht nötig, (inkl.) – reine Pendelleuchte

MEDO LEUCHTENFAMILIE.

PENDEL- ODER DECKENLEUCHE.

	MEDO 30 AMBIENT CW, PHASE	MEDO 40 AMBIENT CW, PHASE	MEDO 60 AMBIENT CW, PHASE	MEDO 90 AMBIENT CL, PHASE
Beispiel				
Leuchtmittel				
Größe	Ø: 30 cm	Ø: 40 cm	Ø: 60 cm	Ø: 90 cm
Lichtstärke	Down: 1230/1280lm Up: 20lm	Down: 2750/2900lm Up: 50lm	Down: 4350/4750lm Up: 120lm	Down: 9500/10100lm Up: 125lm
UGR	25	25	25	25
Dimmbar	C	C	C	C
Abhängeset (exkl.)	1,5 m 5 m	1,5 m 5 m	1,5 m 5 m	1,5 m 5 m

	MEDO 30 AMBIENT CW, DALI	MEDO 40 AMBIENT CW, DALI	MEDO 60 AMBIENT CW, DALI	MEDO 90 AMBIENT CL, DALI
Beispiel				
Leuchtmittel				
Größe	Ø: 30 cm	Ø: 40 cm	Ø: 60 cm	Ø: 90 cm
Lichtstärke	Down: 1230/1280lm Up: 20lm	Down: 2750/2900lm Up: 50lm	Down: 4350/4750lm Up: 120lm	Down: 9500/10100lm Up: 125lm
UGR	25	25	25	25
Dimmbar				
Abhängeset (exkl.)	1,5 m 5 m	1,5 m 5 m	1,5 m 5 m	1,5 m 5 m

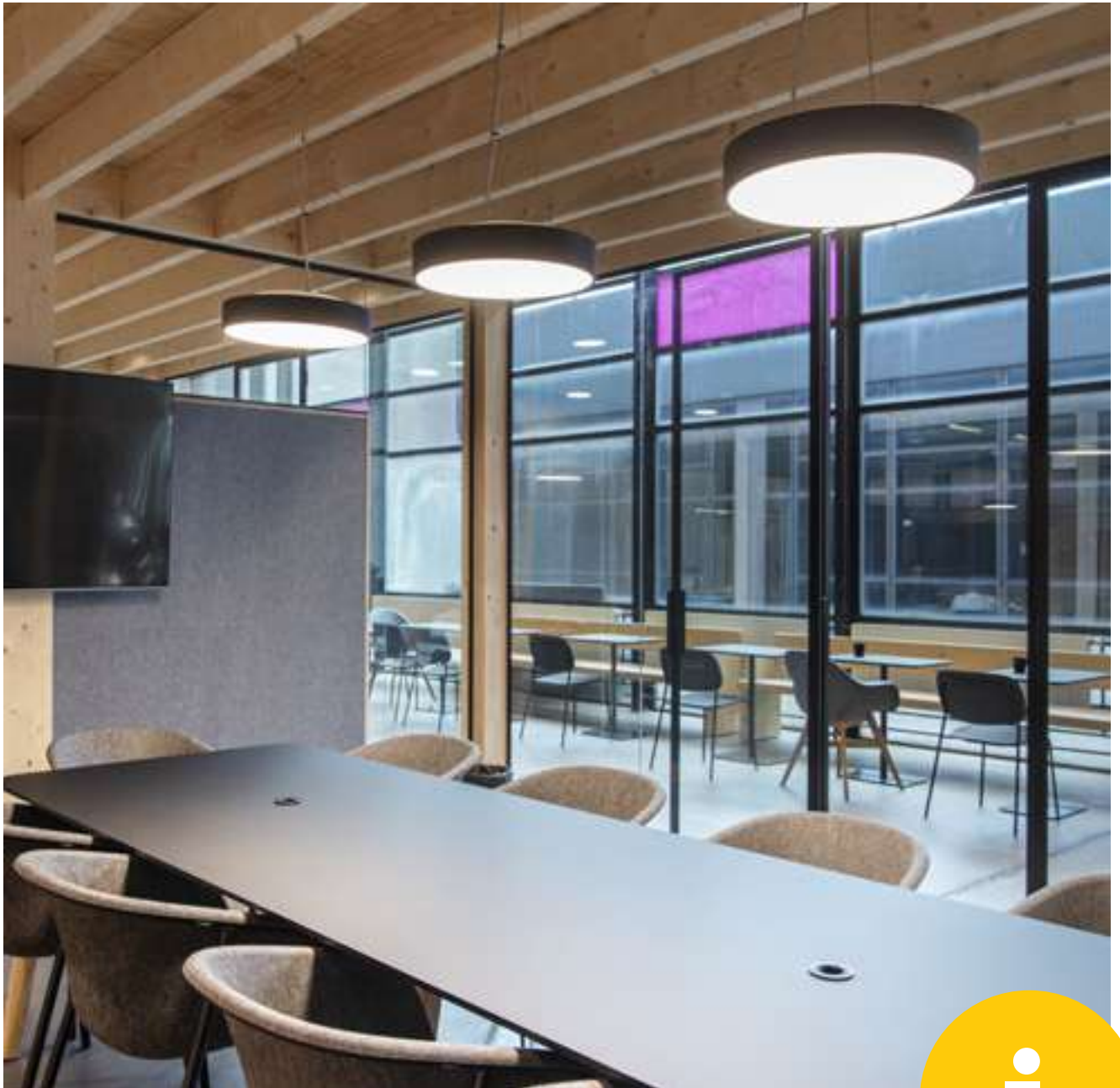

Ambient Effekt – Diese MEDO Varianten verfügen über einen homogenen indirekten Lichtaustritt nach oben.



Farbtemperatur – Bei dieser MEDO Variante können Sie die Farbtemperatur selber wählen. Durch den Schalter auf der Rückseite kann zwischen 3000K und 4000K gewählt werden.



MEDO RING 60
PD, 1-10V



MEDO RING 90
PD, 1-10V

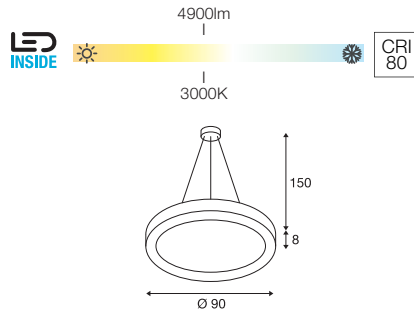
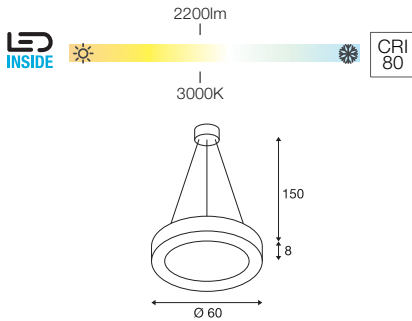

220-240V ~50/60Hz | 700mA
Systemleistung: 33W
Material: Aluminium / Polymethylacrylat (PMMA)

120-277V ~50/60Hz | 1200mA
Systemleistung: 56W
Material: Aluminium / Polymethylacrylat (PMMA)

133840, 133841	2200lm 3000K	

133850, 133851	4900lm 3000K	

1-10V Dimming
Art. Nr. 470505

1-10V Dimming
Art. Nr. 470505

Variante	Art. Nr.
2200lm 3000K CRI80	
<input checked="" type="checkbox"/> schwarz	133840
2200lm 3000K CRI80	
<input type="checkbox"/> weiß	133841

Variante	Art. Nr.
4900lm 3000K CRI80	
<input checked="" type="checkbox"/> schwarz	133850
4900lm 3000K CRI80	
<input type="checkbox"/> weiß	133851



133840 128



133850 128



1002890 129

MEDO RING 60
PD, DALI

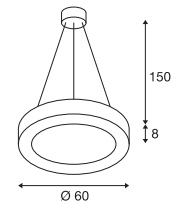
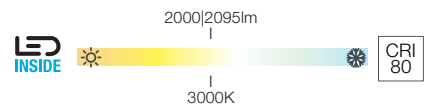

220-240V ~50/60Hz | 700mA
Systemleistung: 34W
Material: Aluminium / Polymethylacrylat (PMMA)



		A → G
1002890, 1002891	2000lm 2095lm 3000K	A + G E

Variante	Art. Nr.
2000lm 3000K CRI80	
■ schwarz	1002890
2095lm 3000K CRI80	
□ weiß	1002891



MEDO 30
CL, 1-10V

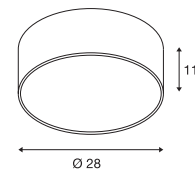
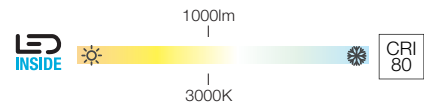

220-240V ~50/60Hz | 350mA
 Systemleistung: 15W
 Material: Aluminium / Polymethylacrylat (PMMA)
 • Abhängeset exkl.



1000855, 1000856, 1000857	1000lm 3000K	



- Abhängeset 1,5m
Art. Nr. **135250**
- Abhängeset 1,5m
Art. Nr. **135251**
- Abhängeset 1,5m
Art. Nr. **135254**
- 1-10V Dimming
Art. Nr. **470505**
- Abhängeset 5m
Art. Nr. **1001950**
- Abhängeset 5m
Art. Nr. **1001951**
- Abhängeset 5m
Art. Nr. **1001952**

Variante	Art. Nr.
1000lm 3000K CRI80	
<input checked="" type="checkbox"/> schwarz	1000855
1000lm 3000K CRI80	
<input type="checkbox"/> weiß	1000856
1000lm 3000K CRI80	
<input checked="" type="checkbox"/> grau	1000857

MEDO 40
CL, 1-10V

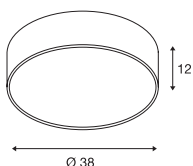
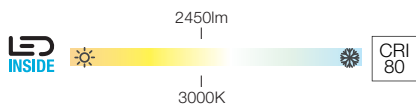

220-240V ~50/60Hz | 700mA
Systemleistung: 28W
Material: Aluminium / Polymethylacrylat (PMMA)
• Abhängeset exkl.

1000864, 1000865, 1000866	2450lm 3000K	

- +**
- Abhängeset 1,5m
Art. Nr. 135250
 - Abhängeset 1,5m
Art. Nr. 135251
 - Abhängeset 1,5m
Art. Nr. 135254
 - 1-10V Dimming
Art. Nr. 470505
 - Abhängeset 5m
Art. Nr. 1001950
 - Abhängeset 5m
Art. Nr. 1001951
 - Abhängeset 5m
Art. Nr. 1001952

Variante	Art. Nr.
2450lm 3000K CRI80	
■ schwarz	1000864
2450lm 3000K CRI80	
□ weiß	1000865
2450lm 3000K CRI80	
■ grau	1000866

MEDO 60
CL, 1-10V

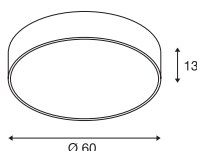
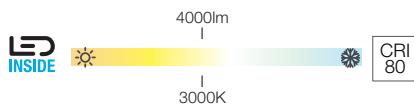
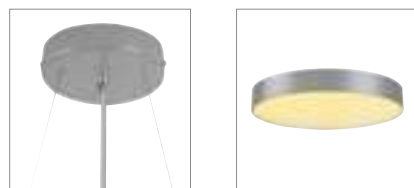

220-240V ~50/60Hz | 1000mA
Systemleistung: 38W
Material: Aluminium / Polymethylacrylat (PMMA)
• Abhängeset exkl.

135120, 135121, 135124	4000lm 3000K	

- +**
- Abhängeset 1,5m
Art. Nr. 135250
 - Abhängeset 1,5m
Art. Nr. 135251
 - Abhängeset 1,5m
Art. Nr. 135254
 - 1-10V Dimming
Art. Nr. 470505
 - Abhängeset 5m
Art. Nr. 1001950
 - Abhängeset 5m
Art. Nr. 1001951
 - Abhängeset 5m
Art. Nr. 1001952

Variante	Art. Nr.
4000lm 3000K CRI80	
■ schwarz	135120
4000lm 3000K CRI80	
□ weiß	135121
4000lm 3000K CRI80	
■ grau	135124

MEDO 90
CL, 1-10V

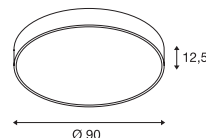
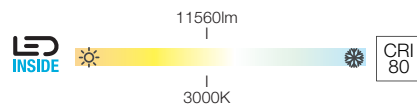

220-240V ~50/60Hz | 2900mA
Systemleistung: 109W
Material: Aluminium / Polymethylacrylat (PMMA)
• Abhängeset exkl.

135170, 135171, 135174	11560lm 3000K	

- +**
- Abhängeset 1,5m
Art. Nr. 135250
 - Abhängeset 1,5m
Art. Nr. 135251
 - Abhängeset 1,5m
Art. Nr. 135254
 - 1-10V Dimming
Art. Nr. 470505
 - Abhängeset 5m
Art. Nr. 1001950
 - Abhängeset 5m
Art. Nr. 1001951
 - Abhängeset 5m
Art. Nr. 1001952

Variante	Art. Nr.
11560lm 3000K CRI80	
■ schwarz	135170
11560lm 3000K CRI80	
□ weiß	135171
11560lm 3000K CRI80	
■ grau	135174

MEDO 60
CL, quadratisch, 1-10V



3800lm
3000K

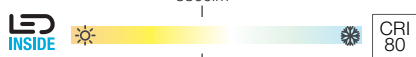

CRI 80

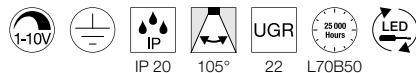
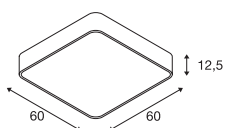

220-240V ~50/60Hz | 1000mA
Systemleistung: 39W
Material: Aluminium / Acryl
• Abhängeset exkl.



1000725, 1000726, 1000727	3800lm 3000K	



- Abhängeset 1,5m
Art. Nr. 135250
- Abhängeset 1,5m
Art. Nr. 135251
- Abhängeset 1,5m
Art. Nr. 135254
- 1-10V Dimming
Art. Nr. 470505
- Abhängeset 5m
Art. Nr. 1001950
- Abhängeset 5m
Art. Nr. 1001951
- Abhängeset 5m
Art. Nr. 1001952

Variante	Art. Nr.
3800lm 3000K CRI80	
<input checked="" type="checkbox"/> schwarz	1000725
3800lm 3000K CRI80	
<input type="checkbox"/> weiß	1000726
3800lm 3000K CRI80	
<input type="checkbox"/> grau	1000727





135074 133

MEDO 30
CL, PHASE

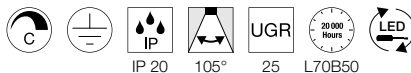
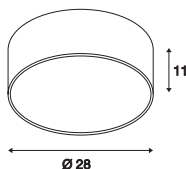
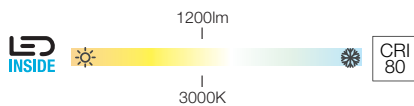

220-240V ~50/60Hz | 350mA
Systemleistung: 16W
Material: Aluminium / Polymethylacrylat (PMMA)
• Abhängeset exkl.



135020, 135021, 135024	1200lm 3000K	



- Abhängeset 1,5m
Art. Nr. 135250
- Abhängeset 1,5m
Art. Nr. 135251
- Abhängeset 1,5m
Art. Nr. 135254
- Abhängeset 5m
Art. Nr. 1001950
- Abhängeset 5m
Art. Nr. 1001951
- Abhängeset 5m
Art. Nr. 1001952

Variante	Art. Nr.
1200lm 3000K CRI80	
■ schwarz	135020
1200lm 3000K CRI80	
□ weiß	135021
1200lm 3000K CRI80	
■ grau	135024

MEDO 40
CL, PHASE

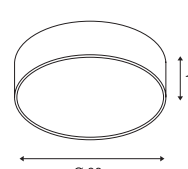
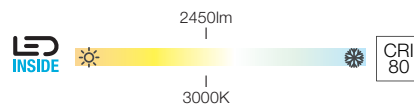

220-240V ~50/60Hz | 700mA
Systemleistung: 28W
Material: Aluminium / Polymethylacrylat (PMMA)
• Abhängeset exkl.



135070, 135071, 135074	2450lm 3000K	



- Abhängeset 1,5m
Art. Nr. 135250
- Abhängeset 1,5m
Art. Nr. 135251
- Abhängeset 1,5m
Art. Nr. 135254
- Abhängeset 5m
Art. Nr. 1001950
- Abhängeset 5m
Art. Nr. 1001951
- Abhängeset 5m
Art. Nr. 1001952

Variante	Art. Nr.
2450lm 3000K CRI80	
■ schwarz	135070
2450lm 3000K CRI80	
□ weiß	135071
2450lm 3000K CRI80	
■ grau	135074

MEDO 30 AMBIENT
CW, PHASE

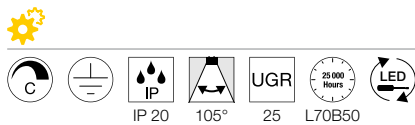
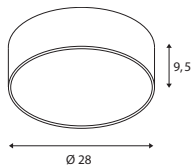
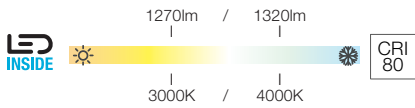

220-240V ~50/60Hz | 350mA
Systemleistung: 15W
Material: Aluminium / Polycarbonat (PC)
• Abhängeset exkl.

Up/Down	1270/1320lm 3000/4000K	

- Abhängeset 1,5m
Art. Nr. 135250
- Abhängeset 1,5m
Art. Nr. 135251
- Abhängeset 1,5m
Art. Nr. 135254
- Abhängeset 5m
Art. Nr. 1001950
- Abhängeset 5m
Art. Nr. 1001951
- Abhängeset 5m
Art. Nr. 1001952

Variante	Art. Nr.
Up: 20/20lm 3000/4000K CRI80 Down: 1250/1300lm 3000/4000K CRI80	■ schwarz 1001877
Up: 20/20lm 3000/4000K CRI80 Down: 1250/1300lm 3000/4000K CRI80	□ weiß 1001881
Up: 20/20lm 3000/4000K CRI80 Down: 1250/1300lm 3000/4000K CRI80	■ grau 1001882

MEDO 40 AMBIENT
CW, PHASE

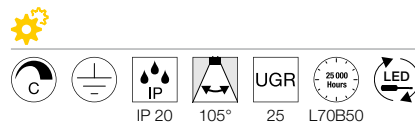
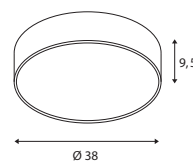
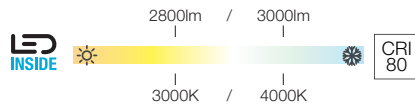

220-240V ~50/60Hz | 700mA
Systemleistung: 30W
Material: Aluminium / Polycarbonat (PC)
• Abhängeset exkl.

Up/Down	2750/3000lm 3000/4000K	

- Abhängeset 1,5m
Art. Nr. 135250
- Abhängeset 1,5m
Art. Nr. 135251
- Abhängeset 1,5m
Art. Nr. 135254
- Abhängeset 5m
Art. Nr. 1001950
- Abhängeset 5m
Art. Nr. 1001951
- Abhängeset 5m
Art. Nr. 1001952

Variante	Art. Nr.
Up: 50/50lm 3000/4000K CRI80 Down: 2750/2950lm 3000/4000K CRI80	■ schwarz 1001883
Up: 50/50lm 3000/4000K CRI80 Down: 2750/2950lm 3000/4000K CRI80	□ weiß 1001884
Up: 50/50lm 3000/4000K CRI80 Down: 2750/2950lm 3000/4000K CRI80	■ grau 1001885

MEDO 60 AMBIENT
CW, PHASE

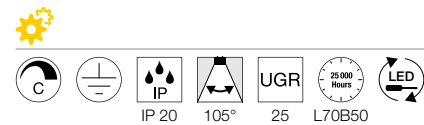
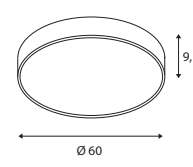
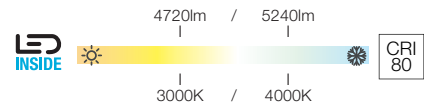

220-240V ~50/60Hz | 1050mA
Systemleistung: 40W
Material: Aluminium / Polycarbonat (PC)
• Abhängeset exkl.

Up/Down	4720/5240lm 3000/4000K	

- Abhängeset 1,5m
Art. Nr. 135250
- Abhängeset 1,5m
Art. Nr. 135251
- Abhängeset 1,5m
Art. Nr. 135254
- Abhängeset 5m
Art. Nr. 1001950
- Abhängeset 5m
Art. Nr. 1001951
- Abhängeset 5m
Art. Nr. 1001952

Variante	Art. Nr.
Up: 120/120lm 3000/4000K CRI80 Down: 4600/5120lm 3000/4000K CRI80	■ schwarz 1001886
Up: 120/120lm 3000/4000K CRI80 Down: 4600/5120lm 3000/4000K CRI80	□ weiß 1001887
Up: 120/120lm 3000/4000K CRI80 Down: 4600/5120lm 3000/4000K CRI80	■ grau 1001888

MEDO 90 AMBIENT
CL, PHASE

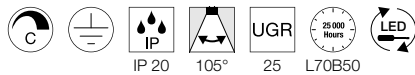
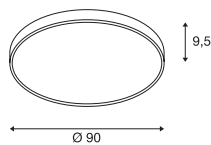
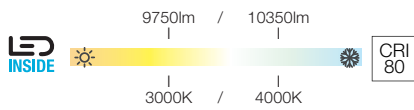

220-240V ~50/60Hz | 1050mA
Systemleistung: 78W
Material: Aluminium / Polycarbonat (PC)
• Abhängeset exkl.



		A → G
Up/Down	9750/10350lm 3000/4000K	A G D



■ Abhängeset 1,5m Art. Nr. 135250	
□ Abhängeset 1,5m Art. Nr. 135251	
■ Abhängeset 1,5m Art. Nr. 135254	
□ Abhängeset 5m Art. Nr. 1001950	
■ Abhängeset 5m Art. Nr. 1001951	
■ Abhängeset 5m Art. Nr. 1001952	

Variante	Art. Nr.
Up: 125/125lm 3000/4000K CRI80 Down: 9625/10225lm 3000/4000K CRI80	
■ schwarz	1001878
Up: 125/125lm 3000/4000K CRI80 Down: 9625/10225lm 3000/4000K CRI80	
□ weiß	1001879
Up: 125/125lm 3000/4000K CRI80 Down: 9625/10225lm 3000/4000K CRI80	
■ grau	1001880



1001886 135

MEDO 30 AMBIENT
CW, DALI

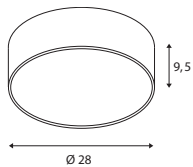
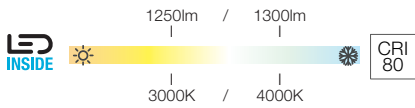

220-240V ~50/60Hz | 350mA
Systemleistung: 15W
Material: Aluminium / Polycarbonat (PC)
• Abhängeset exkl.

Up/Down	1230/1280lm 3000/4000K	

- Abhängeset 1,5m
Art. Nr. 135250
- Abhängeset 1,5m
Art. Nr. 135251
- Abhängeset 1,5m
Art. Nr. 135254
- Abhängeset 5m
Art. Nr. 1001950
- Abhängeset 5m
Art. Nr. 1001951
- Abhängeset 5m
Art. Nr. 1001952

Variante	Art. Nr.
Up: 20/20lm 3000/4000K CRI80 Down: 1230/1280lm 3000/4000K CRI80	
schwarz	1001889
Up: 20/20lm 3000/4000K CRI80 Down: 1230/1280lm 3000/4000K CRI80	
weiß	1001893
Up: 20/20lm 3000/4000K CRI80 Down: 1230/1280lm 3000/4000K CRI80	
grau	1001894

MEDO 40 AMBIENT
CW, DALI

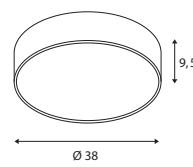
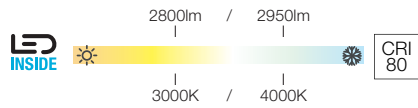

220-240V ~50/60Hz | 700mA
Systemleistung: 30W
Material: Aluminium / Polycarbonat (PC)
• Abhängeset exkl.

Up/Down	2800/2950lm 3000/4000K	

- Abhängeset 1,5m
Art. Nr. 135250
- Abhängeset 1,5m
Art. Nr. 135251
- Abhängeset 1,5m
Art. Nr. 135254
- Abhängeset 5m
Art. Nr. 1001950
- Abhängeset 5m
Art. Nr. 1001951
- Abhängeset 5m
Art. Nr. 1001952

Variante	Art. Nr.
Up: 50/50lm 3000/4000K CRI80 Down: 2750/2900lm 3000/4000K CRI80	
schwarz	1001895
Up: 50/50lm 3000/4000K CRI80 Down: 2750/2900lm 3000/4000K CRI80	
weiß	1001896
Up: 50/50lm 3000/4000K CRI80 Down: 2750/2900lm 3000/4000K CRI80	
grau	1001897

MEDO 60 AMBIENT
CW, DALI

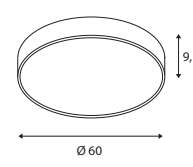
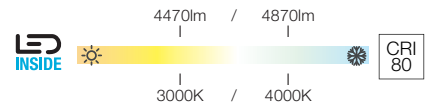

220-240V ~50/60Hz | 1000mA
Systemleistung: 37W
Material: Aluminium / Polycarbonat (PC)
• Abhängeset exkl.

Up/Down	4470/4870lm 3000/4000K	

- Abhängeset 1,5m
Art. Nr. 135250
- Abhängeset 1,5m
Art. Nr. 135251
- Abhängeset 1,5m
Art. Nr. 135254
- Abhängeset 5m
Art. Nr. 1001950
- Abhängeset 5m
Art. Nr. 1001951
- Abhängeset 5m
Art. Nr. 1001952

Variante	Art. Nr.
Up: 120/120lm 3000/4000K CRI80 Down: 4350/4750lm 3000/4000K CRI80	
schwarz	1001898
Up: 120/120lm 3000/4000K CRI80 Down: 4350/4750lm 3000/4000K CRI80	
weiß	1001900
Up: 120/120lm 3000/4000K CRI80 Down: 4350/4750lm 3000/4000K CRI80	
grau	1001899



1001898 136

MEDO 90 AMBIENT
CL, DALI

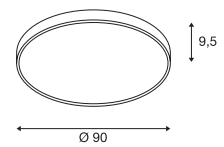
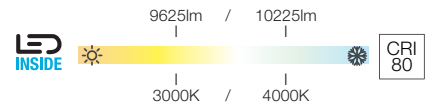
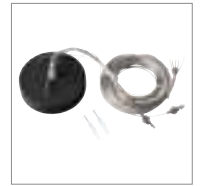

220-240V ~50/60Hz | 1000mA
Systemleistung: 78W
Material: Aluminium / Polycarbonat (PC)
• Abhängeset exkl.



Up/Down	9625/10225lm 3000/4000K	



<input checked="" type="checkbox"/> Abhängeset 1,5m Art. Nr. 135250	
<input type="checkbox"/> Abhängeset 1,5m Art. Nr. 135251	
<input checked="" type="checkbox"/> Abhängeset 1,5m Art. Nr. 135254	
<input type="checkbox"/> Abhängeset 5m Art. Nr. 1001950	
<input checked="" type="checkbox"/> Abhängeset 5m Art. Nr. 1001951	
<input type="checkbox"/> Abhängeset 5m Art. Nr. 1001952	

Variante	Art. Nr.
Up: 125/125lm 3000/4000K CRI80 Down: 9500/10100lm 3000/4000K CRI80	
<input checked="" type="checkbox"/> schwarz	1001890
Up: 125/125lm 3000/4000K CRI80 Down: 9500/10100lm 3000/4000K CRI80	
<input type="checkbox"/> weiß	1001891
Up: 125/125lm 3000/4000K CRI80 Down: 9500/10100lm 3000/4000K CRI80	
<input checked="" type="checkbox"/> grau	1001892

MEDO 60
CL, quadratisch, DALI

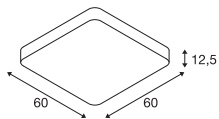
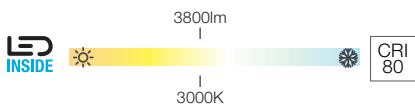

220-240V ~50/60Hz | 1000mA
Systemleistung: 39W
Material: Aluminium / Acryl



1002882	3800lm 3000K	



- Abhängeset 1,5m
Art. Nr. 135250
- Abhängeset 1,5m
Art. Nr. 135251
- Abhängeset 1,5m
Art. Nr. 135254
- Abhängeset 5m
Art. Nr. 1001950
- Abhängeset 5m
Art. Nr. 1001951
- Abhängeset 5m
Art. Nr. 1001952

Variante	Art. Nr.
3800lm 3000K CRI80 <input type="checkbox"/> weiß	1002882

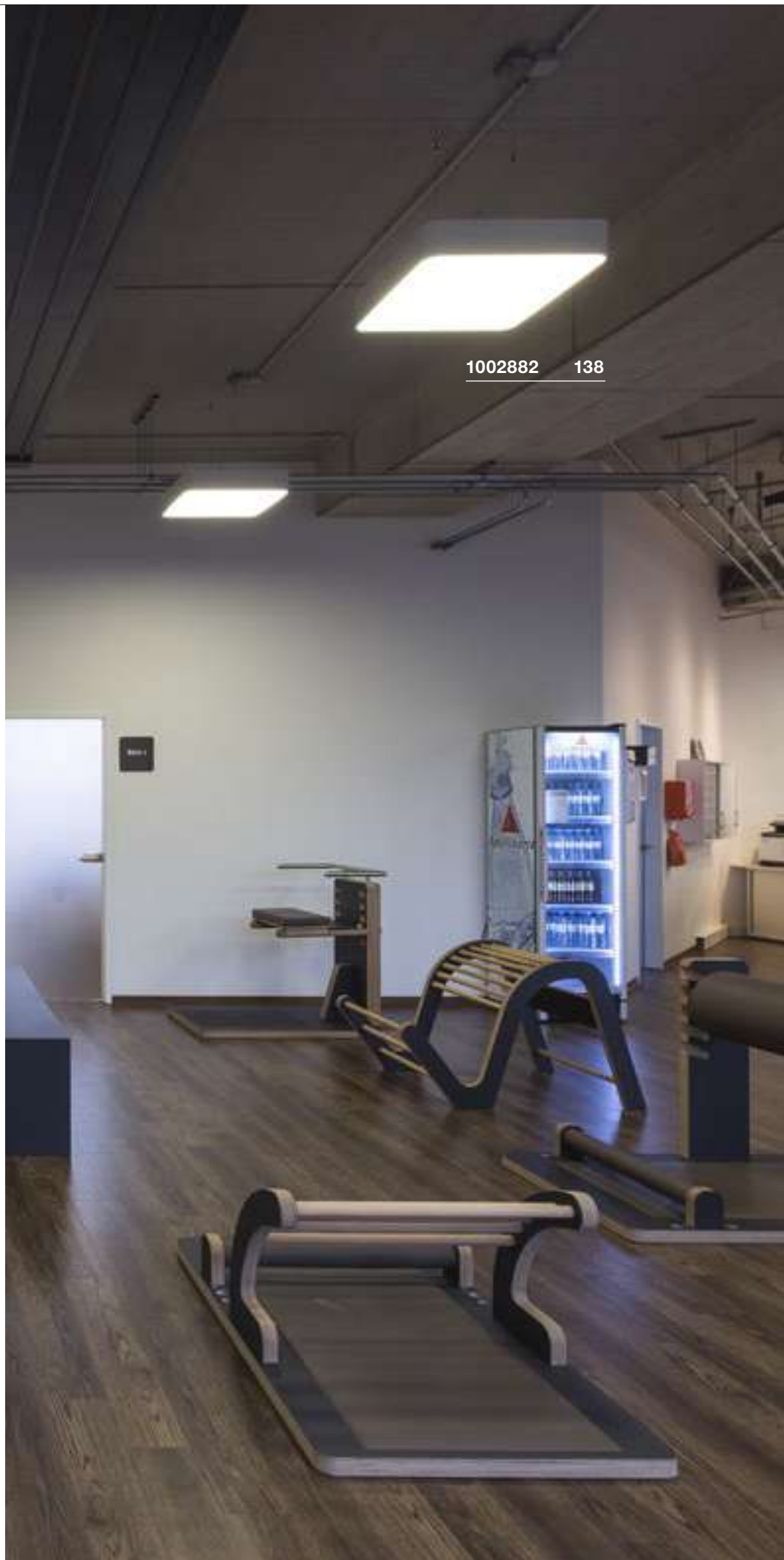

1002882 138



1002858 139



1002858 139

MALANG
CW

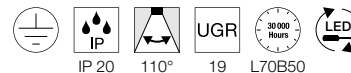
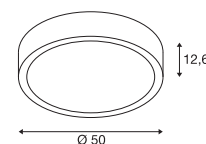
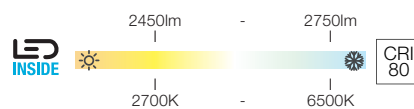

100-240V ~50/60Hz | 24V
Systemleistung: 39W
Material: Aluminium / Polyethylen (PE)

- Steuerbar und dimmbar mit SLV Valetto Fernbedienung 1002994 oder Gateway 1002411
- Ringlicht und Panel sind getrennt steuerbar (Zigbee 3.0)



Die Informationen zur Energieeffizienzklasse für dieses Produkt lagen bei Druck noch nicht vor. Die aktuellsten Produktdaten finden Sie jederzeit unter www.slv.com



■ Abhängeset 1,5m	
Art. Nr. 135250	
□ Abhängeset 1,5m	
Art. Nr. 135251	
■ Abhängeset 1,5m	
Art. Nr. 135254	
□ Abhängeset 5m	
Art. Nr. 1001950	
■ Abhängeset 5m	
Art. Nr. 1001951	
■ Abhängeset 5m	
Art. Nr. 1001952	
□ SLV VALETO® Fernbedienung, CCT/RGBW	
Art. Nr. 1002994	

Variante	Art. Nr.
Ring: 350lm RGB+W (3000K) CRI80	
Panel: 2100-2400lm 2700-6500K CRI80	
□ weiß	1002858

I-PENDANT PRO
PD, 1195x295mm, DALI

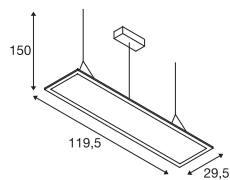
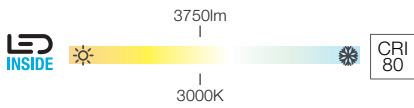
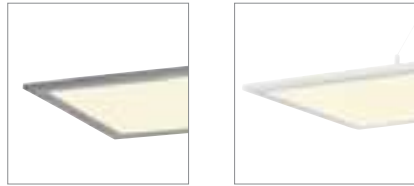
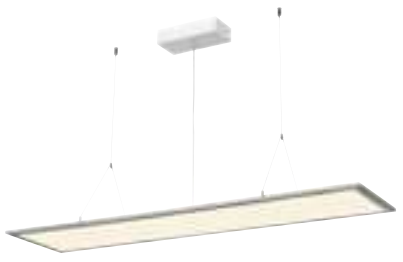

100-277V ~50/60Hz | 1000mA
Systemleistung: 43W
Material: Aluminium / Polymethylacrylat (PMMA)

I-PENDANT PRO
PD, 1195x295mm, DALI

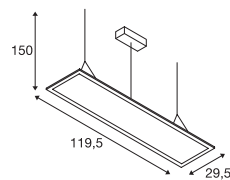
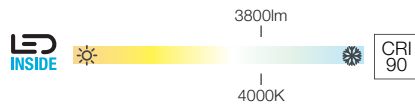
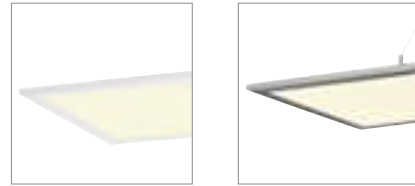

100-240V ~50/60Hz | 1000mA
Systemleistung: 43W
Material: Aluminium / Polymethylacrylat (PMMA)

1003048, 1003050	3750lm 3000K	

Variante	Art. Nr.
3750lm 3000K CRI80 □ weiß	1003048
3750lm 3000K CRI80 ■ grau	1003050

1003049, 1003051	3800lm 4000K	

Variante	Art. Nr.
3800lm 4000K CRI90 □ weiß	1003049
3800lm 4000K CRI80 ■ grau	1003051



1001447 140

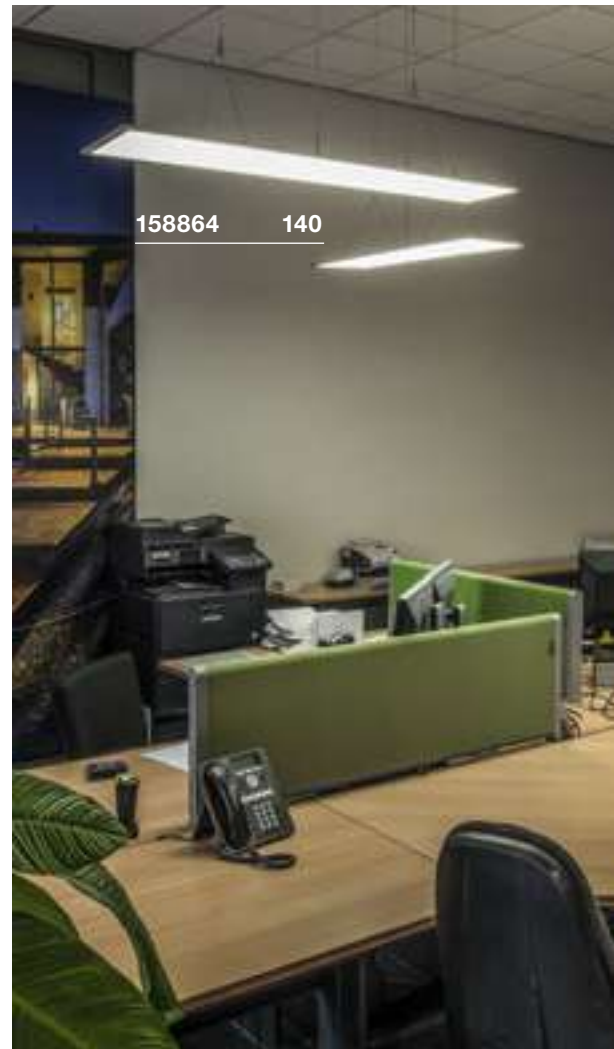

158864 140



1003047 141



1003044 141

PANEL 60
PD, rund, DALI

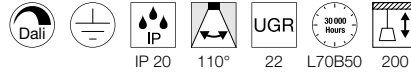
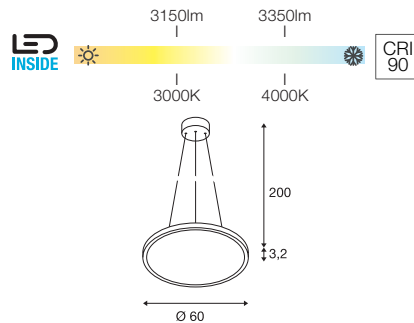

100-277V ~50/60Hz | 1000mA
Systemleistung: 43W
Material: Aluminium / Polymethylacrylat (PMMA)

PANEL 60
PD, rund, DALI

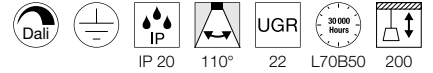
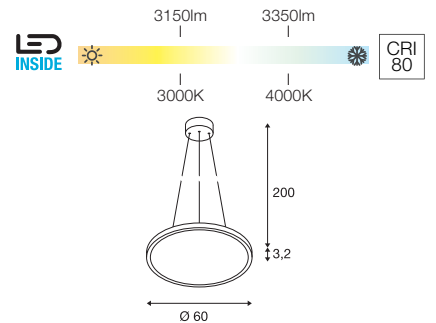

100-277V ~50/60Hz | 1000mA
Systemleistung: 43W
Material: Aluminium / Polymethylacrylat (PMMA)



1003046, 1003047	3150lm 3350lm 3000K 4000K	

Variante	Art. Nr.
3150lm 3000K CRI90 ■ grau	1003046
3350lm 4000K CRI90 ■ grau	1003047



1003044, 1003045	3150lm 3350lm 3000K 4000K	

Variante	Art. Nr.
3150lm 3000K CRI80 □ weiß	1003044
3350lm 4000K CRI80 □ weiß	1003045

NOYA
PD, PHASE

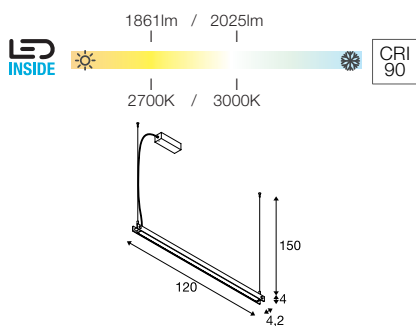
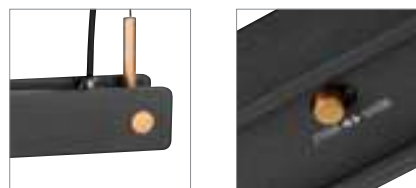

220-240V ~50/60Hz | 700mA
 Systemleistung: 32W
 Material: Aluminium / Polycarbonat (PC)

1003530, 1003532	1861/2025lm 2700/3000K	

Variante	Art. Nr.
1861/2025lm 2700/3000K CRI90	
■ schwarz	1003530
1861/2025lm 2700/3000K CRI90	
□ weiß	1003532



1003532 142



1003530 142

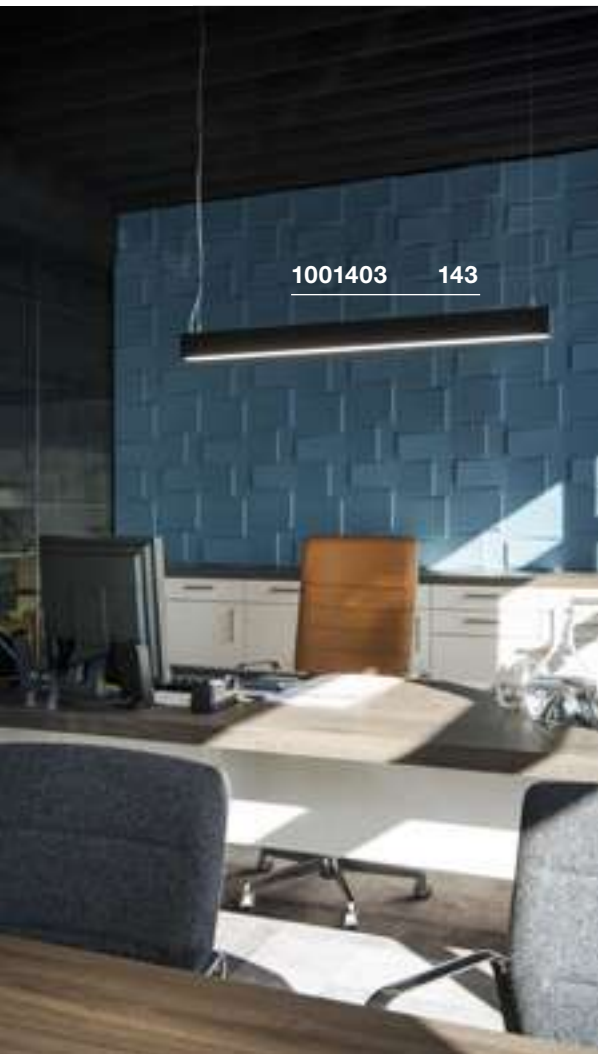

1001403 143



1001406 143

GLENOS
PD, 1m, 1-10V



GLENOS
PD, 2m, 1-10V

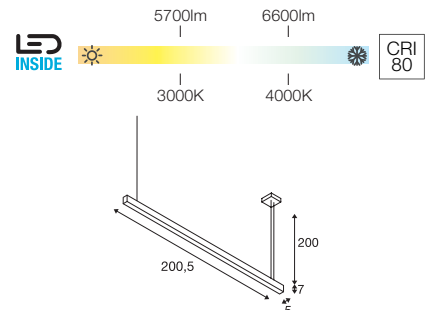
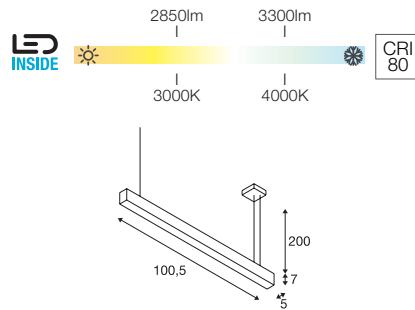

220-240V ~50/60Hz | 1000mA
Systemleistung: 43W
Material: Aluminium / Kunststoff

220-240V ~50/60Hz | 1000mA
Systemleistung: 85W
Material: Aluminium / Kunststoff

1001400, 1001403	2850lm 3300lm 3000 4000K	

1001406, 1001409	5700lm 6600lm 3000 4000K	

1-10V Dimming
Art. Nr. 470505

1-10V Dimming
Art. Nr. 470505

Variante	Art. Nr.
2850lm 3000K CRI80	
■ schwarz	1001400
3300lm 4000K CRI80	
■ schwarz	1001403

Variante	Art. Nr.
5700lm 3000K CRI80	
■ schwarz	1001406
6600lm 4000K CRI80	
■ schwarz	1001409

Q-LINE®
PD, 1m, BAP, PHASE



Q-LINE®
PD, 2m, BAP, PHASE

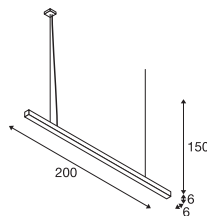
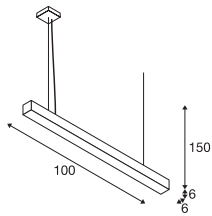
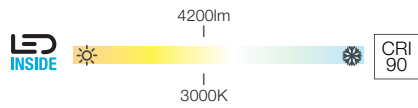
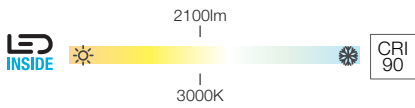
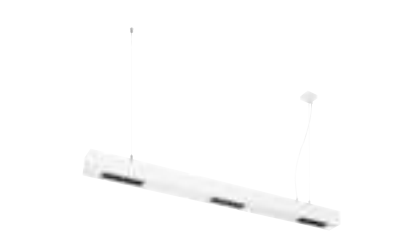
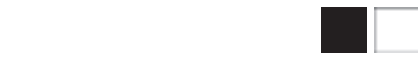

220-240V ~50/60Hz | 900mA
Systemleistung: 46W
Material: Aluminium / Kunststoff

220-240V ~50/60Hz | 900mA
Systemleistung: 93W
Material: Aluminium / Kunststoff

1000927, 1000926	2100lm 3000K	

1000930, 1000929	4200lm 3000K	

Variante	Art. Nr.
2100lm 3000K CRI90	
■ schwarz	1000927
2100lm 3000K CRI90	
□ weiß	1000926

Variante	Art. Nr.
4200lm 3000K CRI90	
■ schwarz	1000930
4200lm 3000K CRI90	
□ weiß	1000929



1000927 144



1000930 144

Q-LINE®
PD, 1m, BAP, PHASE

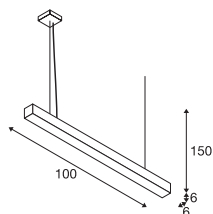
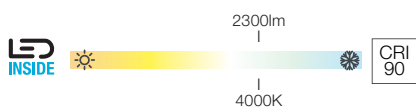
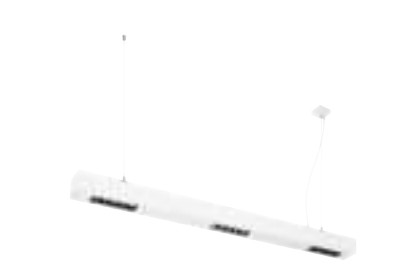

220-240V ~50/60Hz | 900mA
Systemleistung: 46W
Material: Aluminium / Kunststoff

Q-LINE®
PD, 2m, BAP, PHASE

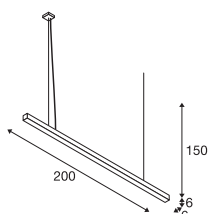
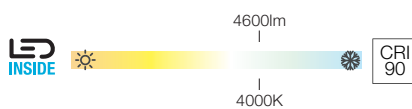

220-240V ~50/60Hz | 900mA
Systemleistung: 93W
Material: Aluminium / Kunststoff

Q-LINE®
PD, DALI, single

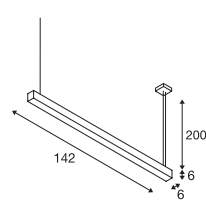
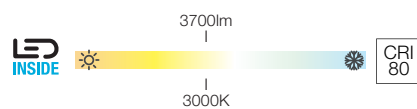
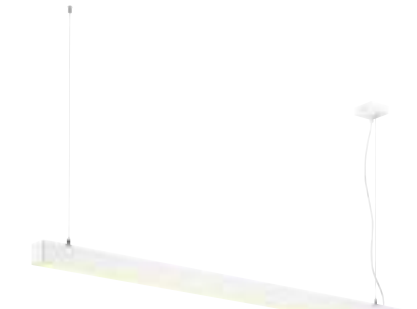

220-240V ~50/60Hz | 700mA
Systemleistung: 47W
Material: Aluminium / Acryl

1000933, 1000932	2300lm 4000K	

Variante	Art. Nr.
2300lm 4000K CRI90	
■ schwarz	1000933
2300lm 4000K CRI90	
□ weiß	1000932

1000936, 1000935	4600lm 4000K	

Variante	Art. Nr.
4600lm 4000K CRI90	
■ schwarz	1000936
4600lm 4000K CRI90	
□ weiß	1000935

1001309, 1001310	3700lm 3000K	

Variante	Art. Nr.
3700lm 3000K CRI80	
■ schwarz	1001309
3700lm 3000K CRI80	
□ weiß	1001310

WORKLIGHT
PD, DALI



NEW

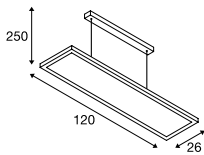
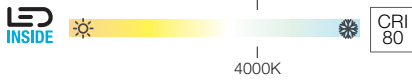

200-240V ~50/60Hz | 1500mA
Systemleistung: 57W
Material: Aluminium



Up	2000lm 4000K		
Down	3000lm 4000K		

Variante	Art. Nr.
Up: 2000lm 4000K CRI80 Down: 3000lm 4000K CRI80	
■ schwarz	1005395 ■
Up: 2000lm 4000K CRI80 Down: 3000lm 4000K CRI80	
□ weiß	1005396 ■



1005395 146



1004744 + 1004672 151 + 147



1004744 + 1004672 151 + 147

OCULUS
PD, single, PHASE

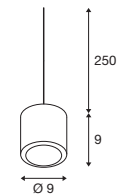
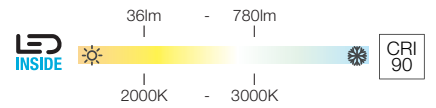

220-240V ~50/60Hz | 250mA
Systemleistung: 11W
Material: Aluminium / Glas

- zusätzliche gefrostete Linse inklusive
- Passendes Zubehör finden Sie auf Seite 151



		A → G
1004672, 1004673	36-780lm 2000-3000K	

Variante	Art. Nr.
36-780lm 2000-3000K CRI90	
■ schwarz	1004672
36-780lm 2000-3000K CRI90	
□ weiß	1004673

SUPROS 78 PD

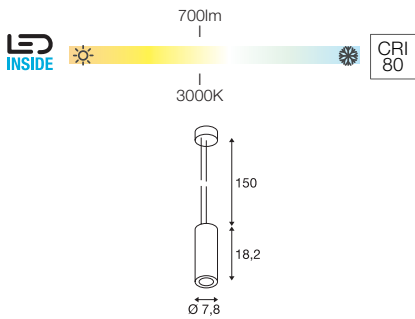

Icons: Gear, C, IP 20, 60°, L70B50, 150, LED

220-240V ~50/60Hz | 250mA
Systemleistung: 12W
Material: Aluminium

SUPROS PD

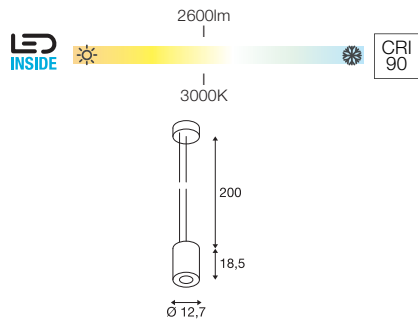

Icons: Gear, IP 20, 60°, L70B50, 200, LED

220-240V ~50/60Hz | 750mA
Systemleistung: 31W
Material: Aluminium

SUPROS PD

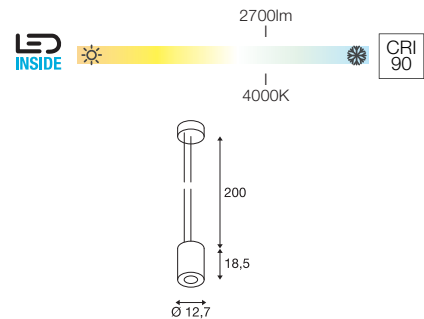

Icons: Gear, IP 20, 60°, L70B50, 200, LED

220-240V ~50/60Hz | 750mA
Systemleistung: 31W
Material: Aluminium

Light bulb icon

133120, 133121	700lm 3000K	A → G E
----------------	----------------	------------

Plus icon

<input type="checkbox"/> Linse 20° Art. Nr. 116302	
<input type="checkbox"/> Linse 40° Art. Nr. 116304	

Variante	Art. Nr.
700lm 3000K CRI80	
<input checked="" type="checkbox"/> schwarz	133120
700lm 3000K CRI80	
<input type="checkbox"/> weiß	133121

Light bulb icon

1003275, 1003276	2600lm 3000K	A → G E
------------------	-----------------	------------

Plus icon

<input checked="" type="checkbox"/> Reflektor 20° Art. Nr. 114102	
<input checked="" type="checkbox"/> Reflektor 40° Art. Nr. 114104	

Variante	Art. Nr.
2600lm 3000K CRI90	
<input checked="" type="checkbox"/> schwarz	1003275
2600lm 3000K CRI80	
<input type="checkbox"/> weiß	1003276

Light bulb icon

1003277, 1003278	2700lm 3000K	A → G E
------------------	-----------------	------------

Plus icon

<input checked="" type="checkbox"/> Reflektor 20° Art. Nr. 114102	
<input checked="" type="checkbox"/> Reflektor 40° Art. Nr. 114104	

Variante	Art. Nr.
2700lm 4000K CRI90	
<input checked="" type="checkbox"/> schwarz	1003277
2700lm 4000K CRI90	
<input type="checkbox"/> weiß	1003278

SUPROS PD

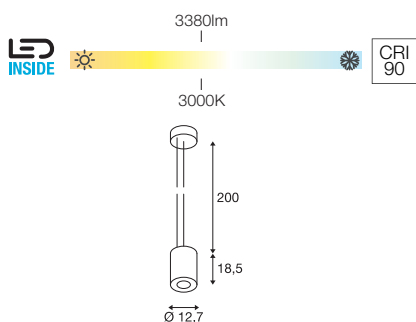

220-240V ~50/60Hz | 950mA
Systemleistung: 36W
Material: Aluminium

SUPROS PD

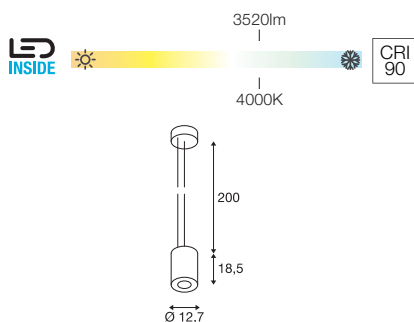

220-240V ~50/60Hz | 950mA
Systemleistung: 36W
Material: Aluminium



1003279, 1003280	3380lm 3000K	

1003281, 1003282	3520lm 3000K	

	Reflektor 20° Art. Nr. 114102	
	Reflektor 40° Art. Nr. 114104	

	Reflektor 20° Art. Nr. 114102	
	Reflektor 40° Art. Nr. 114104	

Variante	Art. Nr.
3380lm 3000K CRI90	
■ schwarz	1003279
3380lm 3000K CRI90	
□ weiß	1003280

Variante	Art. Nr.
3520lm 4000K CRI90	
■ schwarz	1003281
3520lm 4000K CRI90	
□ weiß	1003282

FITU PD, E27



FITU PD, E27

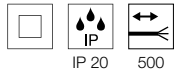
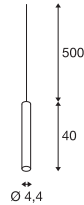
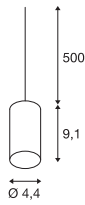

220-240V ~50/60Hz
Material: Aluminium

- Textilkabel
- Offenes Kabelende

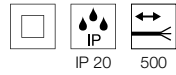

220-240V ~50/60Hz
Material: Aluminium

- Textilkabel
- Offenes Kabelende



E27 <60W



LED E27 | 7,5W | 320°
2700K | 800lm | EEK=F
8kWh/1000h



Art. Nr. 1005303



E27 <60W



LED E27 | 7,5W | 320°
2500K | 700lm | EEK=F
8kWh/1000h



Art. Nr. 1005265

Variante	Art. Nr.
1xE27	
■ schwarz	132690
1xE27	
□ weiß	132691
1xE27	
■ gold	1002168

Variante	Art. Nr.
1xE27	
■ schwarz	1002558
1xE27	
□ weiß	1002562
1xE27	
■ gold	1002564
1xE27	
□ aluminium	1002563

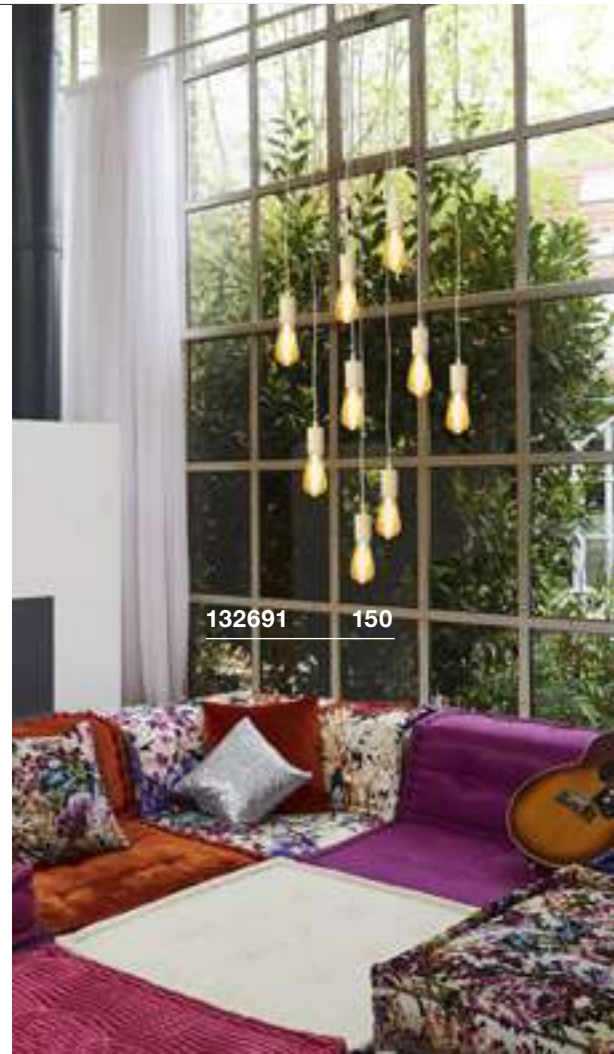

132691 150



1002558 150

ZUBEHÖR FITU MIX & MATCH

Fitu 1er Deckenrosette

16A max.
Stahl
H: 3,9 cm
Ø: 8,5 cm
inkl. Zugentlastung



Variante	Art. Nr.
■ schwarz	132600
□ weiß	132601
■ chrom	132605
■ gold	1002163

Fitu 3er Deckenrosette

16A max.
Stahl
H: 5,4 cm
Ø: 22 cm
inkl. Zugentlastung



Variante	Art. Nr.
■ schwarz	132610
□ weiß	132611
■ chrom	132615 ▼
■ gold	1002164

Fitu 5er Deckenrosette

16A max.
Stahl
H: 6 cm
Ø: 33 cm
inkl. Zugentlastung



Variante	Art. Nr.
■ schwarz	132620
□ weiß	132621
■ chrom	132625 ▼
■ gold	1002165

Deckenrosette 3-fach

16A max.
Stahl
L: 60 cm B: 8,5 cm H: 5 cm
inkl. Zugentlastung



Variante	Art. Nr.
■ schwarz	1001818
□ weiß	1001819
■ gold	1002264

Deckenrosette 5-fach

16A max.
Stahl
L: 120 cm B: 8,5 cm H: 5 cm



Variante	Art. Nr.
■ schwarz	1001820
□ weiß	1001821
■ gold	1002265

Deckenrosette Aufbau

16A max.
Stahl
H: 2,6 cm
Ø: 9 cm



Variante	Art. Nr.
■ schwarz	1004744
□ weiß	1004745
■ chrom	1004746

Deckenrosette Einbau

16A max.
Stahl / Polyamid 66 (PA 66)
H: 3,3 cm
Ø: 8,5 cm



Variante	Art. Nr.
■ schwarz	1004674
□ weiß	1004675
■ chrom	1004676

Deckenhaken

Aluminium
L: 4,6 cm
Ø: 1,8 cm



Variante	Art. Nr.
■ schwarz	132670
□ weiß	132671

Kabelhaken

Aluminium
L: 3,1 cm
Ø: 1,4 cm



Variante	Art. Nr.
■ schwarz	132680
□ weiß	132681

1-Phasen Leuchtenadapter

6A max.
Polycarbonat (PC)
L: 8,2 cm B: 3,5 cm H: 4,2 cm
Max. mechanische Belastung 2 kg



Variante	Art. Nr.
■ schwarz	143120
□ weiß	143121
■ grau	143124

3-Phasen Leuchtenadapter

10A max.
Kunststoff
Max. mechanische Belastung 5 kg



Variante	Art. Nr.
■ schwarz	145990
□ weiß	1001542
■ grau	145994

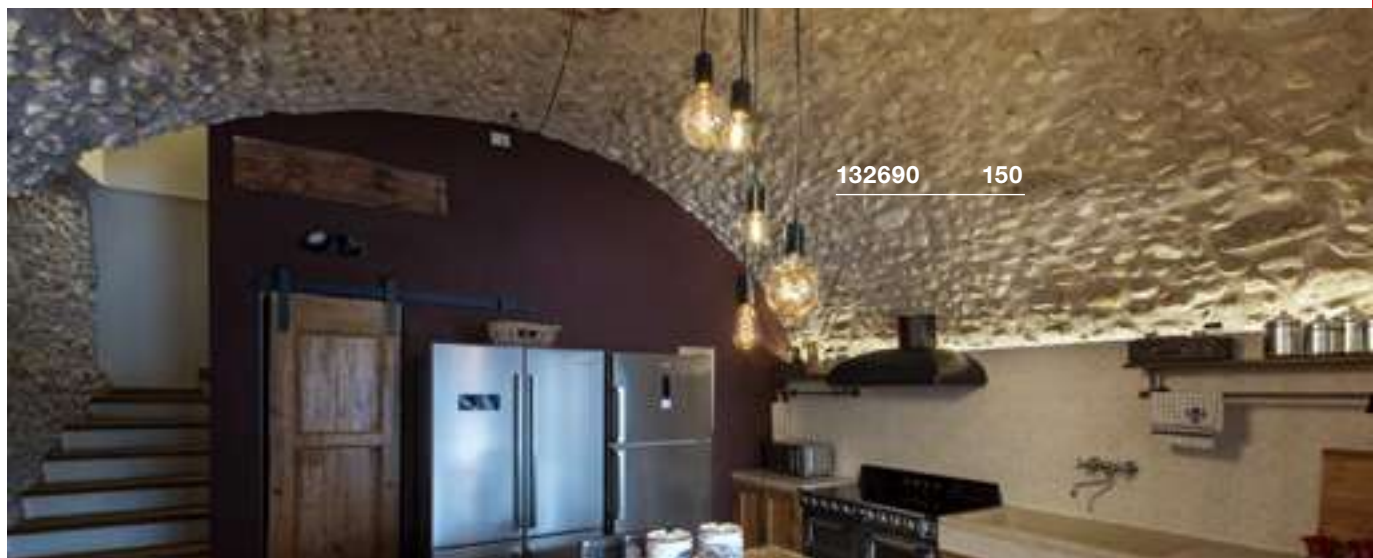

132690 150

SLV FENDA. MIX & MATCH.

MIX & match

MIX & MATCH Video

bit.ly/slv-mix-match



132662 + 156122 154 + 155

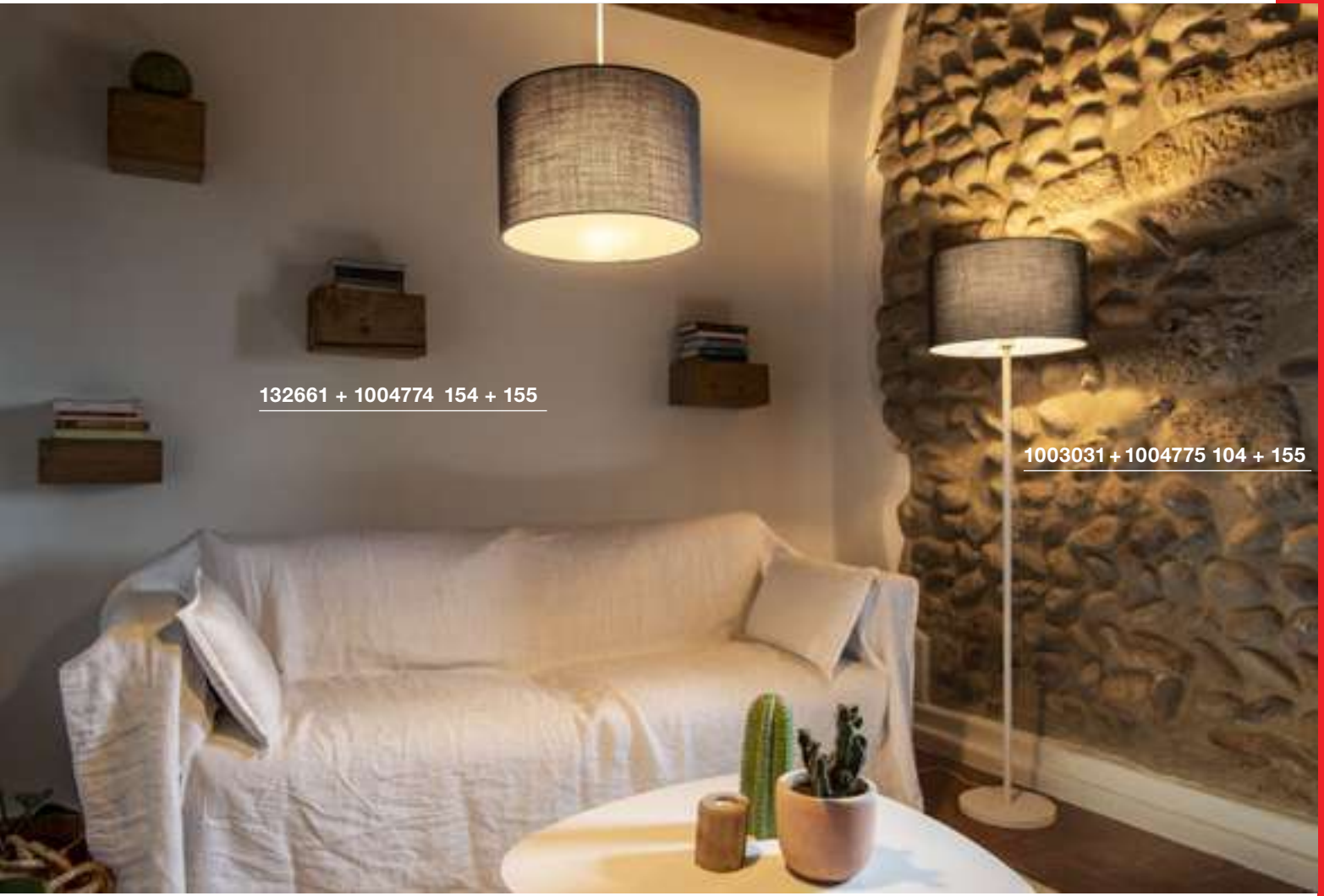

FENDA
PD, E27

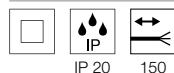
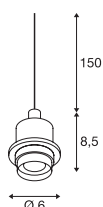

220-240V ~50/60Hz
Material: Stahl / Kunststoff

- Offenes Kabelende
- Passendes Zubehör finden Sie auf Seite 151



E27 <60W



LED E27 | 9W | 220°
2700K | 800lm | EEK=F
9kWh/1000h



Art. Nr. 1005301

Variante	Art. Nr.
1xE27	
■ schwarz	132660
1xE27	
□ weiß	132661
1xE27	
■ chrom	132662

FENDA
Glasschirm



H: 20 cm
Ø: 12,5 cm
Material: Glas

- 25W max.

Variante	Art. Nr.
■ braun	1000773
□ weiß	1002217

FENDA
Ø 40 cm, rund



H: 30 cm
Ø: 40 cm
Material: Polymethylacrylat (PMMA)

- max. 40W

Variante	Art. Nr.
□ weiß	1000764





132662 + 156113 154 + 155

FENDA
15 cm, rund



NEW VARIANT



H: 40 cm
Ø: 15 cm
Material: Textil / Stahl

Variante	Art. Nr.
<input checked="" type="checkbox"/> schwarz / kupfer	156152
<input type="checkbox"/> weiß	156141
<input type="checkbox"/> beige	156143
<input type="checkbox"/> grau	1004773

FENDA
30 cm, rund



NEW VARIANT



H: 20 cm
Ø: 30 cm
Material: Textil / Stahl

Variante	Art. Nr.
<input checked="" type="checkbox"/> schwarz / kupfer	155592
<input type="checkbox"/> weiß	155582
<input type="checkbox"/> beige	155583
<input type="checkbox"/> grau	1004774



132660 + 1002217 154

FENDA
45 cm, rund



NEW VARIANT



H: 28 cm
Ø: 45,5 cm
Material: Textil / Stahl

Variante	Art. Nr.
<input type="checkbox"/> Acrylglasabdeckung	Art. Nr. 156100

Variante	Art. Nr.
<input checked="" type="checkbox"/> schwarz / kupfer	156122
<input type="checkbox"/> weiß	156111
<input type="checkbox"/> beige	156113
<input type="checkbox"/> grau	1004775

FENDA
Ø 70 cm, rund



H: 36 cm
Ø: 70 cm
Material: Textil / Stahl

• max. 20W

Variante	Art. Nr.
<input type="checkbox"/> Acrylglasabdeckung	Art. Nr. 1000957

Variante	Art. Nr.
<input checked="" type="checkbox"/> schwarz / kupfer	1000580
<input type="checkbox"/> weiß	1000579

ACCANTO
PD, E27



TRIADEM
PD, E27

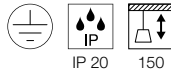
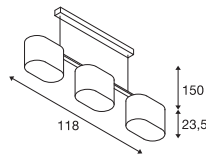
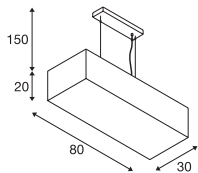
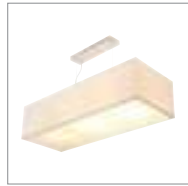

220-240V ~50/60Hz
Material: Stahl / Textil

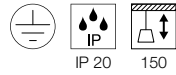

220-240V ~50/60Hz
Material: Stahl / Textil



E27 <40W L: 13 cm



LED E27 | 9W | 220°
2700K | 800lm | EEK=F
9kWh/1000h

Art. Nr. 1005301



E27 <60W L: 14 cm



LED E27 | 13,2W | 220°
2700K | 1300lm | EEK=F
13kWh/1000h

Art. Nr. 1005302



Variante	Art. Nr.
3xE27	
■ schwarz	1002946 ▼
3xE27	
□ weiß	1002947 ▼

Variante	Art. Nr.
3xE27	
■ schwarz	155870 ▼
3xE27	
□ weiß	155871 ▼



155871 156



155870 156



1003436 157

HELIA AMBIENT 35
PD, PHASE



HELIA AMBIENT 35
PD

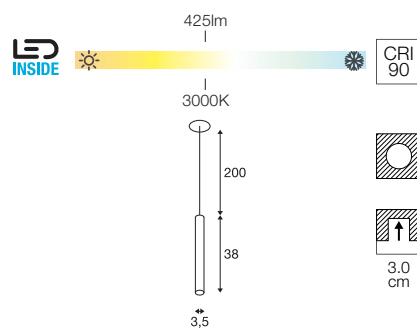
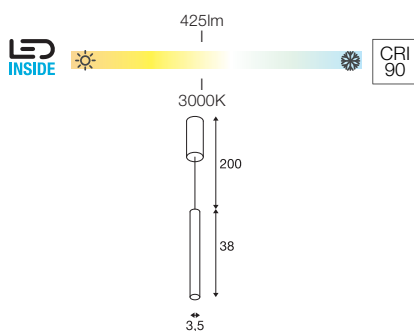
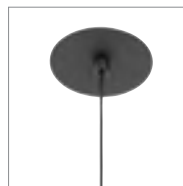

L70B50 200

L70B50 200

220-240V ~50/60Hz | 500mA
Systemleistung: 9W
Material: Aluminium / Acryl

500mA
Systemleistung: 7,5W
Material: Aluminium / Acryl

- inkl. Einbaurosette
- Ø Einbaurosette 68mm

		A → G
1003436	425lm 3000K	A f G E

		A → G
1003435	425lm 3000K	A f G E

Variante	Art. Nr.
425lm 3000K CRI90 ■ schwarz	1003436

Variante	Art. Nr.
425lm 3000K CRI90 ■ schwarz	1003435

HELIA 30
PD, PHASE



590|620|670lm

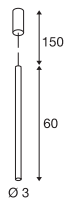
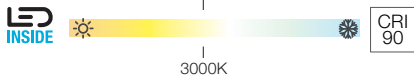

220-240V ~50/60Hz | 500mA
Systemleistung: 9,2W
Material: Aluminium

152360, 152361, 1002172	590lm 670lm 620lm 3000K	

HELIA 30
PD

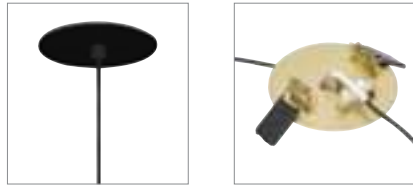

500|550lm

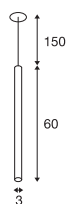
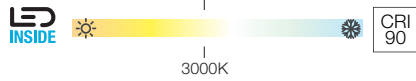

500mA
Systemleistung: 7,5W
Material: Aluminium

- LED Treiber exkl.
- Materialstärke Einbaufäche: max 12 mm

158400, 158401, 1002170	500lm 550lm 3000K	

LED Treiber 500mA |
15W dimmbar
Art. Nr. 464144

Variante	Art. Nr.
500lm 3000K CRI90	
■ schwarz	158400
550lm 3000K CRI90	
□ weiß	158401
550lm 3000K CRI90	
■ gold	1002170

Variante	Art. Nr.
590lm 3000K CRI90	
■ schwarz	152360
670lm 3000K CRI90	
□ weiß	152361
620lm 3000K CRI90	
■ gold	1002172



158400 158

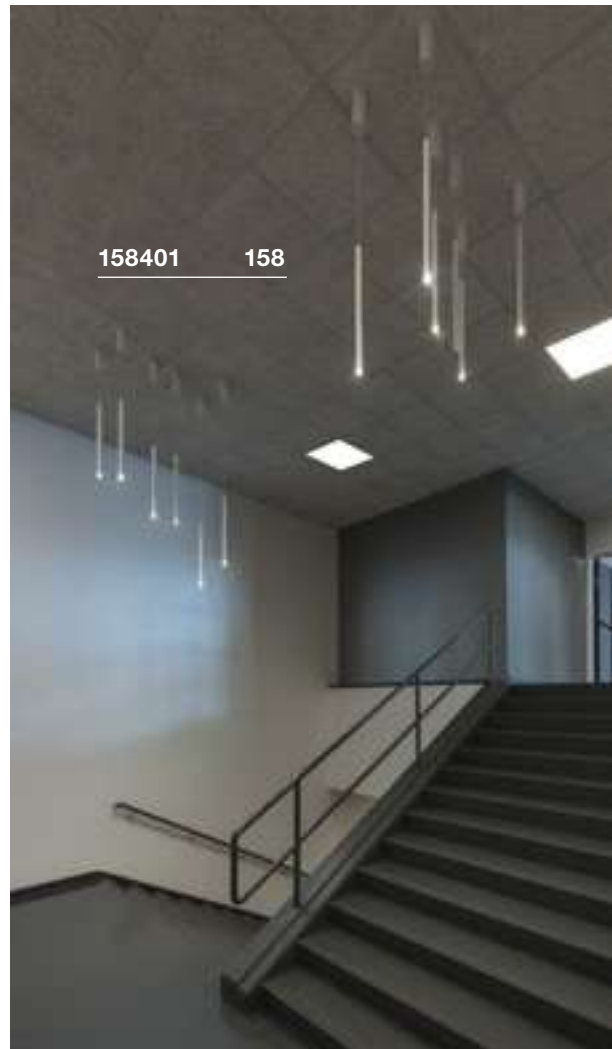

158401 158



152370 159

152360 158



158410 159

HELIA 40
PD, PHASE

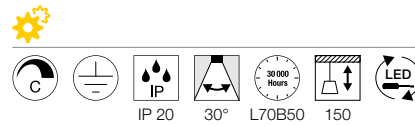
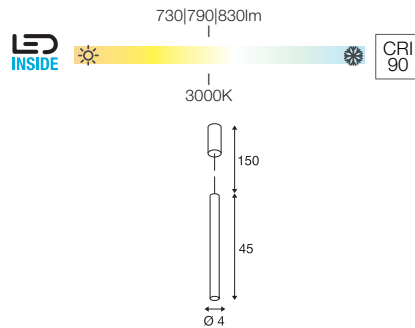

220-240V ~50/60Hz | 500mA
Systemleistung: 10W
Material: Aluminium

152370, 152371, 1002171	730lm 830lm 790lm 3000K	

Variante	Art. Nr.
730lm 3000K CRI90	
■ schwarz	152370
830lm 3000K CRI90	
□ weiß	152371
790lm 3000K CRI90	
■ gold	1002171

HELIA 40
PD

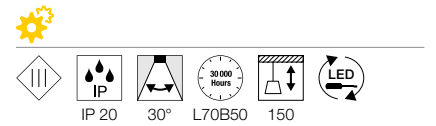
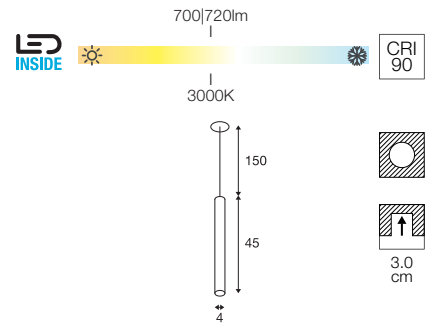
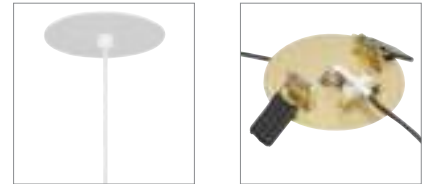

500mA
Systemleistung: 9W
Material: Aluminium

- LED Treiber exkl.
- Materialstärke Einbaufäche: max 12mm

158410, 158411, 1002169	700lm 720lm 3000K	

□ LED Treiber 500mA |
15W dimmbar
Art. Nr. 464144

Variante	Art. Nr.
700lm 3000K CRI90	
■ schwarz	158410
720lm 3000K CRI90	
□ weiß	158411
720lm 3000K CRI90	
■ gold	1002169

ASTINA
PD, QPAR51

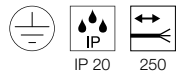
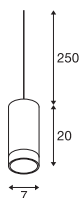

220-240V ~50/60Hz
Material: Aluminium

- Offenes Kabelende
- Passendes Zubehör finden Sie auf Seite 151



GU10 <10W



LED GU10 51mm | 4W | 36°
2700K | 270lm | EEC=G
4kWh/1000h



Art. Nr. 1004972

Variante	Art. Nr.
1xGU10	
■ schwarz	1002939
1xGU10	
□ weiß	1002937
1xGU10	
■ grau	1002938

1002939 160





151853 161



149381 161

ENOLA B
PD, QPAR51

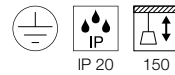
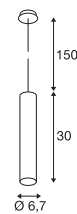

220-240V ~50/60Hz
Material: Aluminium / Stahl



GU10 <50W



LED GU10 51mm | 4W | 36°
2700K | 270lm | EEK=G
4kWh/1000h



Art. Nr. 1004972

Variante	Art. Nr.
1xGU10	
■ schwarz	151850
1xGU10	
□ weiß	151851
1xGU10	
■ gold	151853

ENOLA
PD, E27

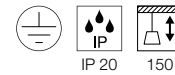
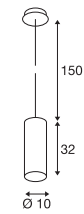
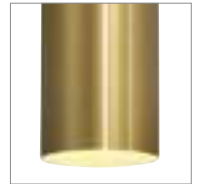

220-240V ~50/60Hz
Material: Aluminium / Stahl



E27 <60W
Ø: 9 cm L: 18 cm



LED E27 | 13,2W | 220°
2700K | 1300lm | EEK=F
13kWh/1000h



Art. Nr. 1005302

Variante	Art. Nr.
1xE27	
■ schwarz	149388
1xE27	
□ weiß	149381
1xE27	
■ gold	149387

PANTILO 20
PD, E27

PANTILO 28
PD, E27

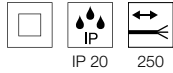
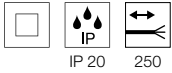
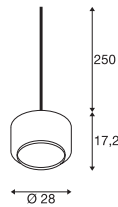
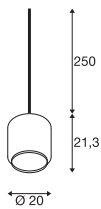
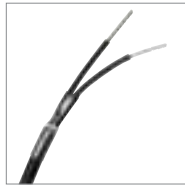
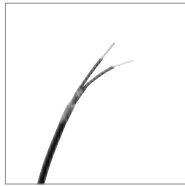

200-240V ~50/60Hz
Material: Glas

200-240V ~50/60Hz
Material: Glas

- Offenes Kabelende
- Passendes Zubehör finden Sie auf Seite 151

- Offenes Kabelende
- Passendes Zubehör finden Sie auf Seite 151



E27 <15W



E27 <15W



LED E27 | 7,5W | 320°
2700K | 800lm | EEK=F
8kWh/1000h



Art. Nr. 1005303



LED E27 | 7,5W | 320°
2500K | 700lm | EEK=F
8kWh/1000h



Art. Nr. 1005265

Variante	Art. Nr.
1xE27	
chrom	1003004
1xE27	
kupfer	1003005

Variante	Art. Nr.
1xE27	
chrom	1003006
1xE27	
kupfer	1003007

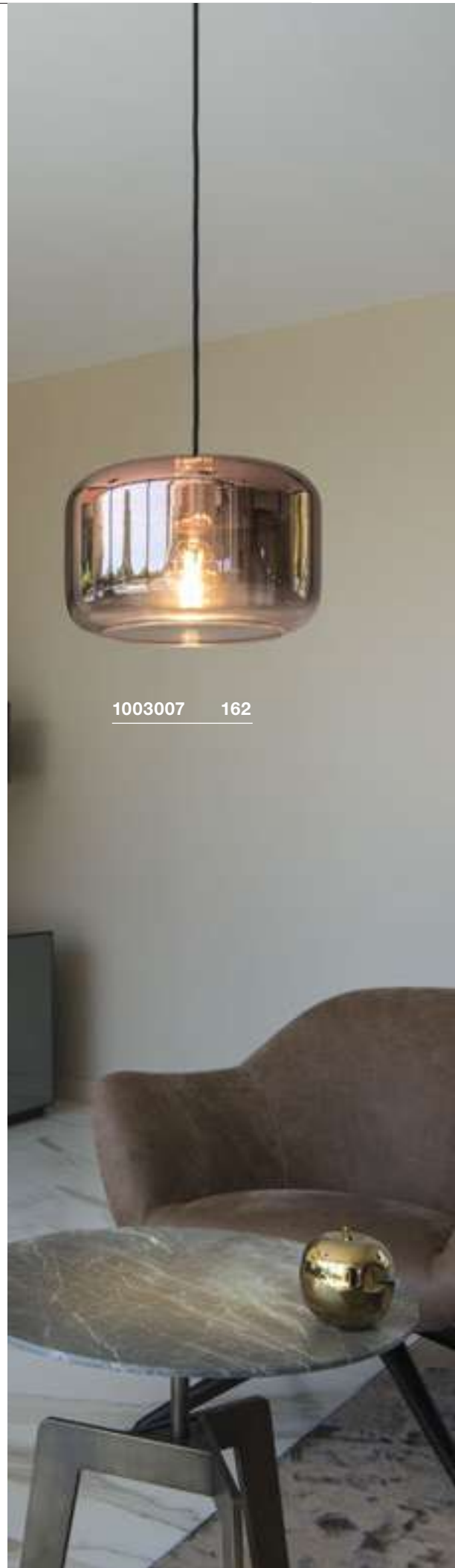

1003007 162



1003443 163



1003444 163

PANTILO CONVEX 29
PD, E27

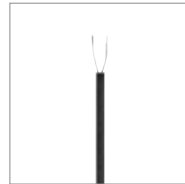

SOCKET INSIDE <15 W

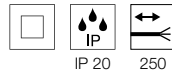
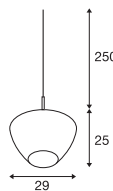

200-240V ~50/60Hz
Material: Glas

- Offenes Kabelende
- Passendes Zubehör finden Sie auf Seite 151



E27 <15W



LED E27 | 7,5W | 320°
2500K | 700lm | EEK=F
8kWh/1000h

Art. Nr. 1005265



Variante	Art. Nr.
E27 chrom	1003443

PANTILO CONVEX 40
PD, E27



SOCKET INSIDE 40 W

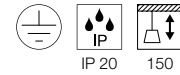
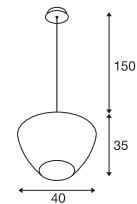

220-240V ~50/60Hz
Material: Glas / Stahl



E27 <15W



LED E27 | 7,5W | 320°
2500K | 700lm | EEK=F
8kWh/1000h

Art. Nr. 1005265



Variante	Art. Nr.
E27 chrom	1003444

ANELA
PD, PHASE



LISENNE
PD, E27

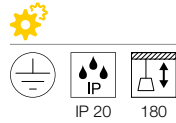
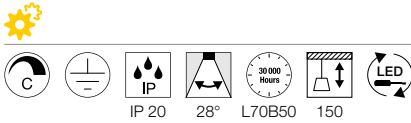
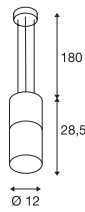
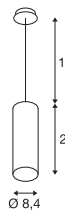
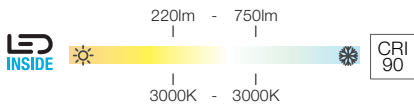

220-240V ~50/60Hz | 500mA
Systemleistung: 10W
Material: Aluminium

220-240V ~50/60Hz
Material: Basalt / Glas

- Reflektor exkl.
- Lichtstrom mit Reflektor 1000809 = 500lm/
Lichtstrom mit Reflektor 1000810 = 620lm/
Lichtstrom mit Reflektor 1000811 = 200lm/
Lichtstrom mit Reflektor 1000812 = 600lm

1000813	220-750lm 3000K	

E27 <23W
Ø: 5,9 cm L: 15 cm

LED E27 | 7,5W | 320°
2700K | 800lm | EEK=F
8kWh/1000h

Art. Nr. 1005268

- Reflektor 28°
Art. Nr. 1000809
- Reflektor 28°
Art. Nr. 1000810
- Reflektor 28°
Art. Nr. 1000811
- Reflektor 28°
Art. Nr. 1000812

Variante	Art. Nr.
220-750lm 3000K CRI90	
glänzend schwarz	1000813

Variante	Art. Nr.
1xE27	
grau	155714

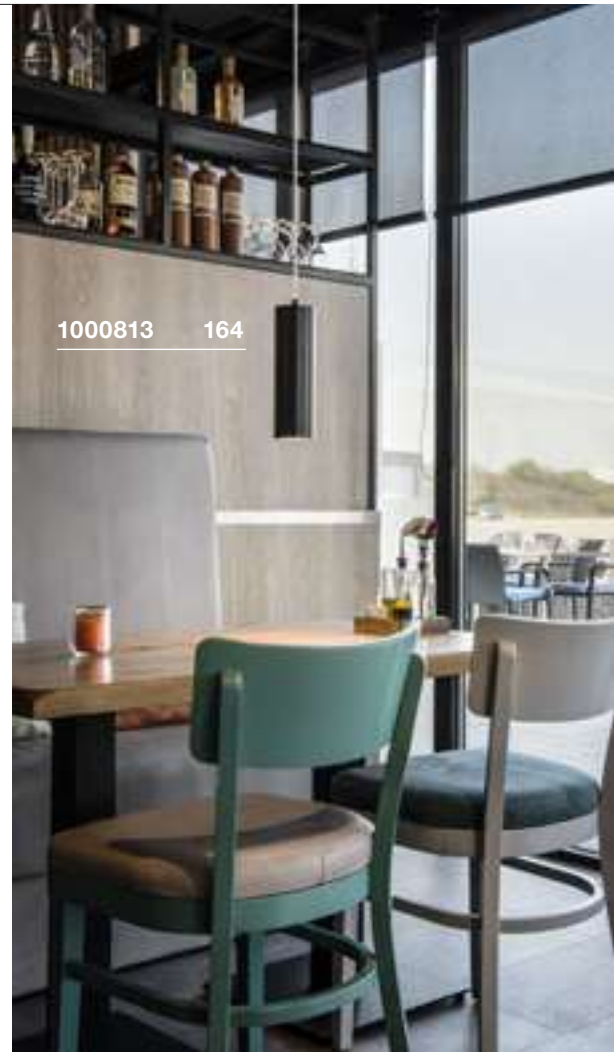



133444 165



1003432 165

TONGA®
PD, E14



QUADRASS
PD, E27

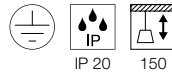
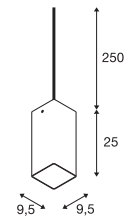
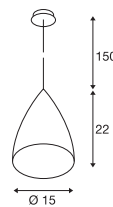

220-240V ~50/60Hz
Material: Aluminium / Glas

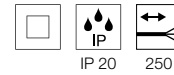

220-240V ~50/60Hz
Material: Stahl / Glas

- Offenes Kabelende
- Passendes Zubehör finden Sie auf Seite 151



E14 <60W
Ø: 5 cm L: 13 cm



LED E14 | 4,2W | 320°
2700K | 350lm | EEK=G
5kWh/1000h

Art. Nr. 1005285



E27 <40W
Ø: 6,5 cm L: 18 cm



LED E27 | 9W | 220°
2700K | 800lm | EEK=F
9kWh/1000h

Art. Nr. 1005301



Variante	Art. Nr.
1xE14	
■ grau	133444

Variante	Art. Nr.
1xE27	
■ chrom	1003432

PARA CONE GL
PD, GU10



NEW



<25
W

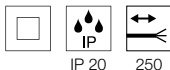
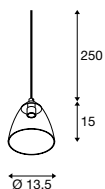

220-240V ~50/60Hz
Material: Aluminium / Glas

• Passendes Zubehör finden Sie auf Seite 151



GU10 <25W



LED GU10 | 3,2W
2700K | 270lm | EEC=G
4kWh/1000h



Art. Nr. 1003101

Variante	Art. Nr.
1xGU10	
■ schwarz	1006159
1xGU10	
□ weiß	1006160

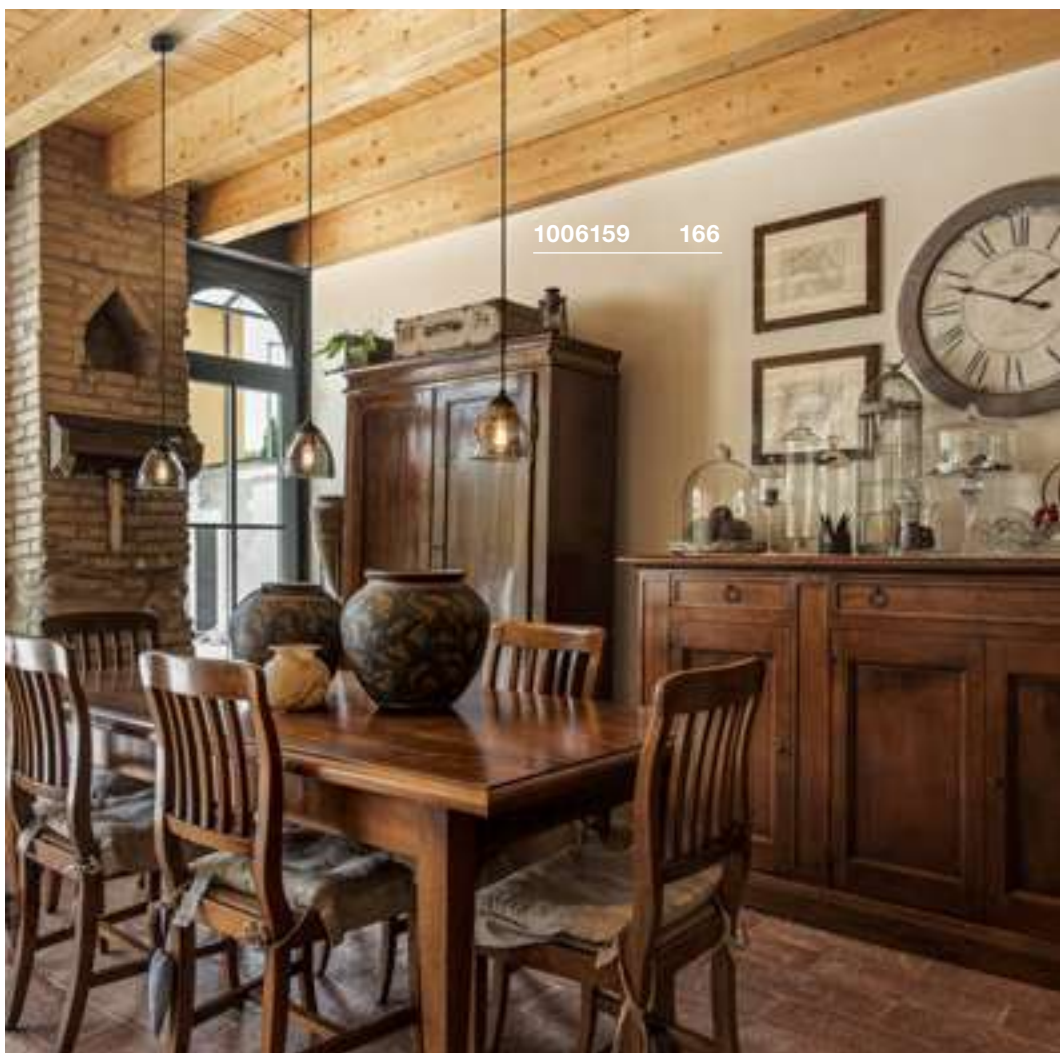
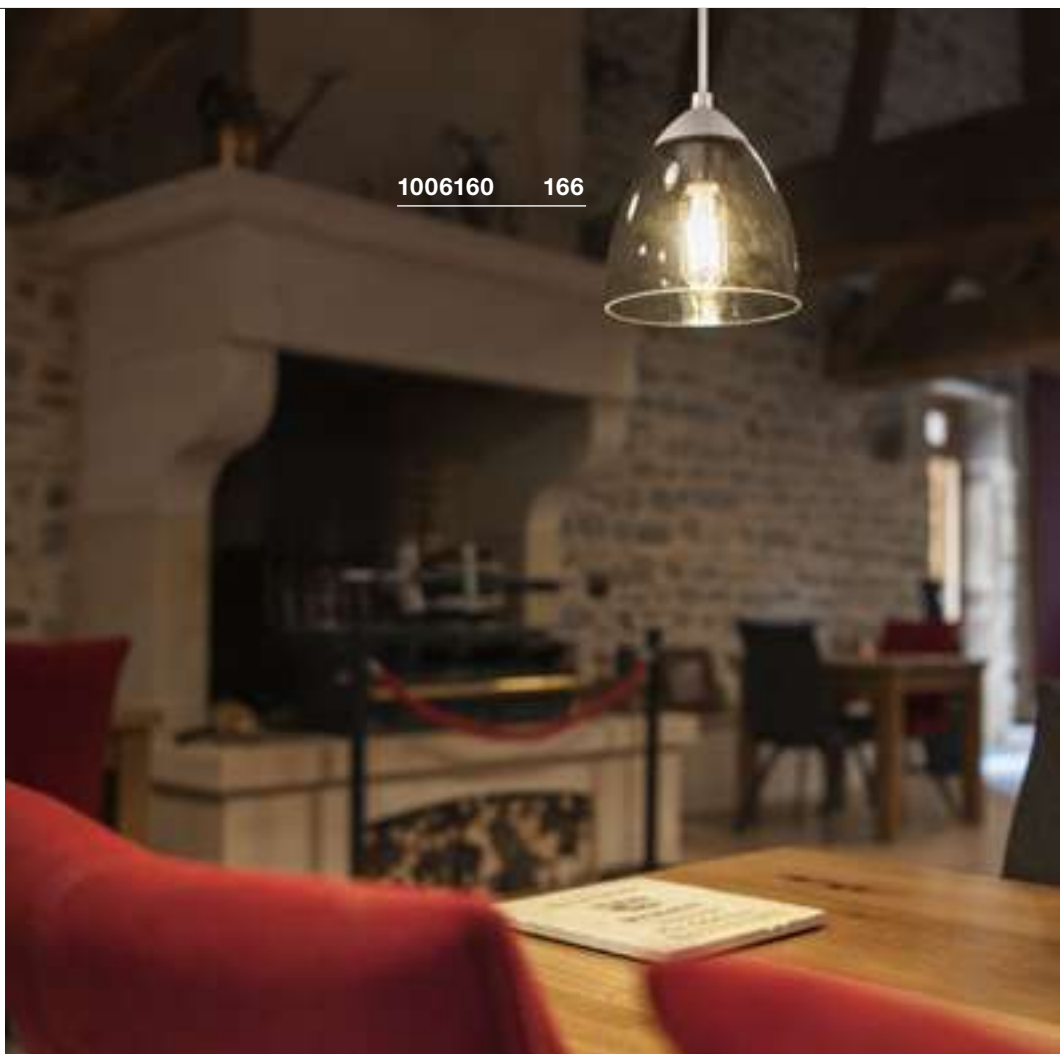



133019 167

PARA CONE 30 PD, E27



SOCKET INSIDE **<60 W**

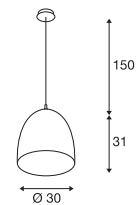

IP 20

150

220-240V ~50/60Hz
Material: Aluminium / Stahl

- Textilkabel
- Schwarz/gold Version mit goldenem Reflektor
- Alle anderen Version mit weißem Reflektor



E27 <15W



LED E27 | 7,5W | 320°
2700K | 800lm | EEK=F
8kWh/1000h



Art. Nr. 1005303

Variante	Art. Nr.
1xE27	
glänzend schwarz/gold	133060
1xE27	
kupfer	133019

1002949 169





PHELIA 25
PD, E27

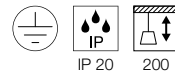
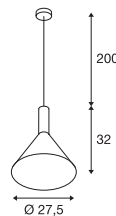

220-240V ~50/60Hz
Material: Aluminium

- Textilkabel



E27 <23W



LED E27 | 13,2W | 220°
2700K | 1300lm | EEK=F
13kWh/1000h

Art. Nr. 1005302

Variante	Art. Nr.
1xE27	
■ schwarz / gold	1002949
1xE27	
■ schwarz / weiß	133310

PHELIA 30
PD, E27

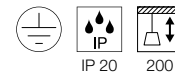
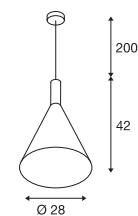

220-240V ~50/60Hz
Material: Aluminium

- Textilkabel



E27 <23W



LED E27 | 7,5W | 320°
2700K | 800lm | EEK=F
8kWh/1000h

Art. Nr. 1005268

Variante	Art. Nr.
1xE27	
■ schwarz / gold	1002950
1xE27	
■ schwarz / weiß	133320

FORCHINI 50
PD, E27



FORCHINI 70
PD, E27



SOCKET INSIDE <40 W

SOCKET INSIDE <40 W

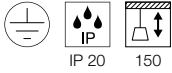
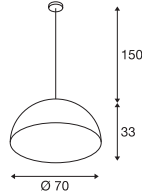
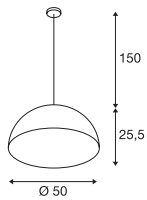

230V ~50Hz
Material: GFK

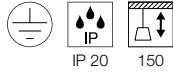

220-240V ~50/60Hz
Material: GFK



E27 <40W L: 20 cm



LED E27 | 9W | 220°
2700K | 800lm | EEK=F
9kWh/1000h



Art. Nr. 1005301



E27 <40W L: 20 cm



G125 | 7,5W | 180°
2700K | 720lm | EEK=F
8kWh/1000h



Art. Nr. 1005306

Variante	Art. Nr.
1xE27 ■ schwarz / gold	155530

Variante	Art. Nr.
1xE27 ■ schwarz / gold	1001701



155530 170



1559100 171



1001701 170



FORCHINI M 40
PD, E27



FORCHINI M 50
PD, E27

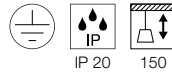
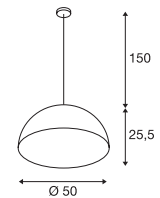
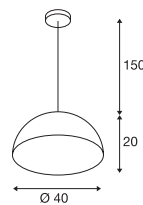

230V ~50Hz
Material: Aluminium / Stahl

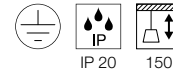

230V ~50Hz
Material: Aluminium / Stahl



E27 <40W L: 15,2 cm



E27 <40W L: 18 cm



A60 | 7,5W | 180°
2700K | 720lm | EEK=F
8kWh/1000h



Art. Nr. 1005305



G125 | 7,5W | 180°
2700K | 720lm | EEK=F
8kWh/1000h



Art. Nr. 1005306

Variante	Art. Nr.
1xE27	
■ schwarz / gold	155910

Variante	Art. Nr.
1xE27	
■ schwarz / gold	155930

LIGHT EYE® 90
PD, GU10

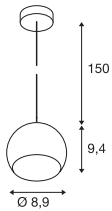

IP 20 150
220-240V ~50/60Hz
Material: Stahl

- Textilkabel



GU10 <6W



LED GU10 51mm | 4W | 36°
2700K | 270lm | EEK=G
4kWh/1000h



Art. Nr. 1004972



- Leuchtmittel Dekoring Ø 5,7 cm
Art. Nr. 151040
- Leuchtmittel Dekoring Ø 5,7 cm
Art. Nr. 151041
- Leuchtmittel Dekoring Ø 5,7 cm
Art. Nr. 151049



Variante	Art. Nr.
1xGU10	
■ schwarz	133490
1xGU10	
□ weiß	133491

LIGHT EYE® 150
PD, QPAR111

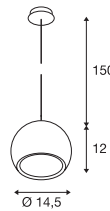

IP 20 150
220-240V ~50/60Hz
Material: Stahl

- Textilkabel



GU10 <75W



LED GU10 | 12,5W | 60°
2700K | 1000lm | EEK=F
13kWh/1000h



Art. Nr. 1005277

Variante	Art. Nr.
1xGU10	
■ weiß/chrom	133481
1xGU10	
■ chrom	133482
1xGU10	
■ kupfer	133489



133481 172



133482 172

1002045 173

SUN / BIG SUN
PD, E27

SOCKET INSIDE            **<60 W**

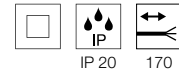
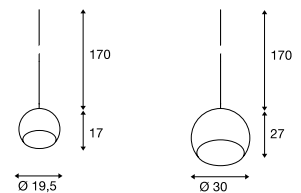

IP 20 170

230V ~50Hz
Material: Stahl / Glas

- Offenes Kabelende
- Passendes Zubehör finden Sie auf Seite 151



E27 <60W
Ø: 7 cm L: 12 cm



LED E27 | 13,2W | 220°
2700K | 1300lm | EEK=F
13kWh/1000h

Art. Nr. 1005302



Variante	Art. Nr.
1xE27 Ø: 19,5 cm weiß / chrom	1002045
1xE27 Ø: 30 cm weiß / chrom	1002046

ROTOBALL 25
PD, E27

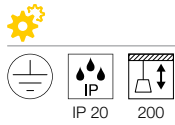
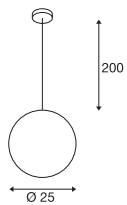
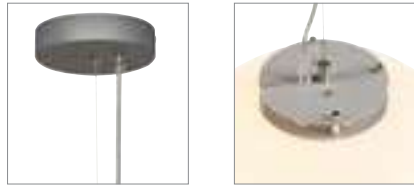

230V ~50Hz
Material: Stahl / Polyethylen (PE)

E27 <24W
Ø: 7 cm

LED E27 | 7,5W | 320°
2700K | 700lm | EEK=F
8kWh/1000h



Art. Nr. 1005304

Variante	Art. Nr.
1xE27 weiß / silbergrau	165390

ROTOBALL 40
PD, E27

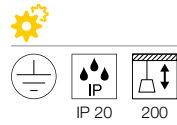
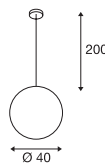
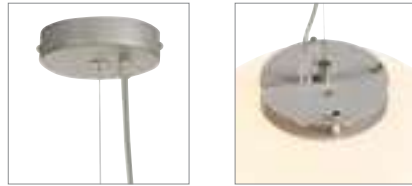

230V ~50Hz
Material: Stahl / Polyethylen (PE)

E27 <24W
Ø: 9,5 cm

LED E27 | 9W | 220°
2700K | 800lm | EEK=F
9kWh/1000h



Art. Nr. 1005301

Variante	Art. Nr.
1xE27 weiß / silbergrau	165410

ROTOBALL 50
PD, E27

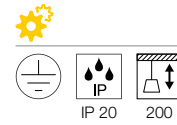
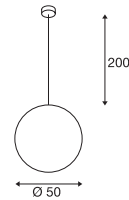

230V ~50Hz
Material: Stahl / Polyethylen (PE)

E27 <24W
Ø: 9,5 cm

LED E27 | 13,2W | 220°
2700K | 1300lm | EEK=F
13kWh/1000h



Art. Nr. 1005302

Variante	Art. Nr.
1xE27 weiß / silbergrau	165400

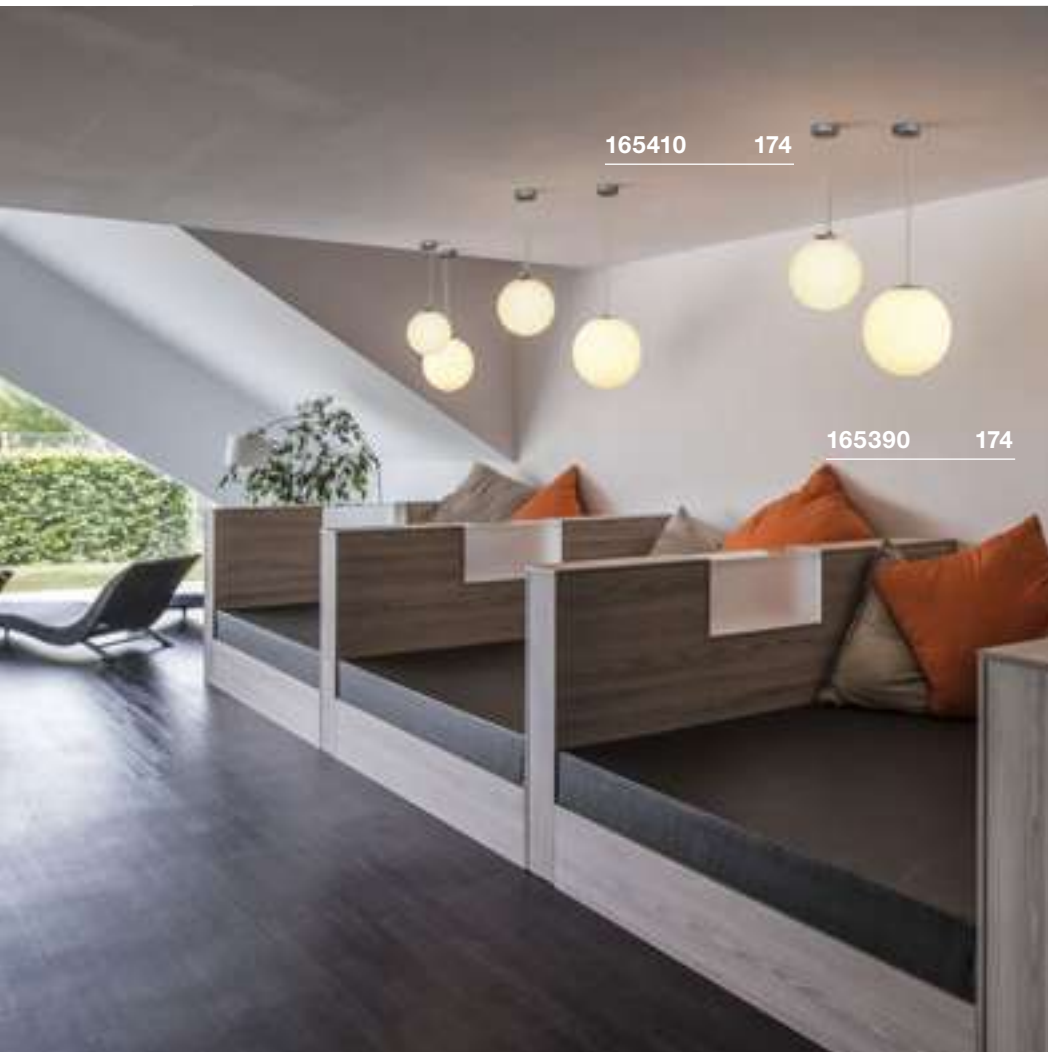

165410 174

165390 174



1002047 174

PLASTRA 25
PD, rund, TCR-TSE



SOCKET INSIDE  <11 W

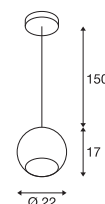

IP 20

150

230V ~50Hz
Material: Gips / Stahl



GX53 <11W



LED GX53 | 6,1W | 120°
4000K | 520lm | EEK=F
6kWh/1000h



Art. Nr. 1005269

Variante	Art. Nr.
1xGX53 □ weiß	1002047

PARA DOME
PD, E27

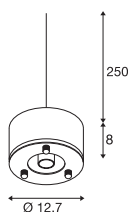

220-240V ~50/60Hz
Material: Aluminium



E27 <150W
Ø: 7 cm



LED E27 | 9W | 220°
2700K | 800lm | EEK=F
9kWh/1000h



Art. Nr. 1005301

Variante	Art. Nr.
1xE27	
■ schwarz	1005214
1xE27	
■ grau	1005215

PARA DOME
Schirm



H: 20,6 cm
Ø: 30,8 cm
Material: Aluminium

Variante	Art. Nr.
■ schwarz	1005216
■ grau	1005217

PARA DOME
Schirm



H: 20 cm
Ø: 31,5 cm
Material: Polycarbonat (PC)

Variante	Art. Nr.
■ transparent	1005218





1005214

176

1005218

176



165359 179



1000827 + 1000918 179



PARA 380
PD, E27

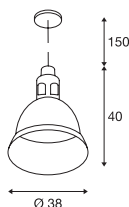

220-240V ~50/60Hz
Material: Aluminium

E27 <20W

LED E27 | 13,2W | 220°
 2700K | 1300lm | EEK=F
 13kWh/1000h
Art. Nr. 1005302

Variante	Art. Nr.
1xE27	
schwarz	165359
1xE27	
aluminium	165358

PARA FLAC
PD/CL, DALI

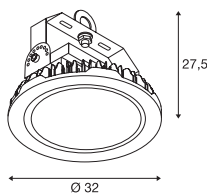

220-240V ~50/60Hz | 1600mA
Systemleistung: 104W
Material: Aluminium / Polycarbonat (PC)

- Produkt wird ohne Kette geliefert und kann mit handelsüblichen Ketten abgedandelt werden
- Offenes Kabelende

1003107	12800lm 4000K	

- Verbindungsbox IP68, 3-polig
Art. Nr. 228730
- Reflektor
Art. Nr. 1000918
- Reflektor
Art. Nr. 1001691
- Reflektor Abdeckung
Art. Nr. 1001692

Variante	Art. Nr.
12800lm 4000K CRI80	
schwarz	1003107

PARA FLAC
PD/CL

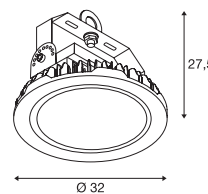
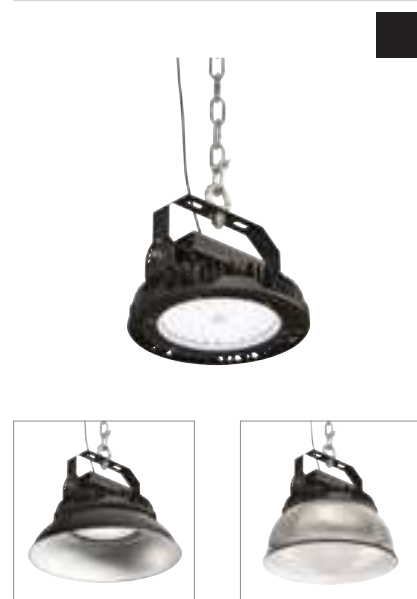

220-240V ~50/60Hz | 1600mA
Systemleistung: 100W
Material: Aluminium / Polycarbonat (PC)

- Produkt wird ohne Kette geliefert und kann mit handelsüblichen Ketten abgedandelt werden
- Offenes Kabelende

1000827	12800lm 4000K	

- Verbindungsbox IP68, 3-polig
Art. Nr. 228730
- Reflektor
Art. Nr. 1000918
- Reflektor
Art. Nr. 1001691
- Reflektor Abdeckung
Art. Nr. 1001692

Variante	Art. Nr.
12800lm 4000K CRI80	
schwarz	1000827

ÜBERRASCHEND WANDELBAR.

WANDLEUCHTEN BRINGEN
INDIVIDUELLE LICHTSPOTS.

Ein Blickfang für die Wand – ein echtes Highlight für den Raum: Wandleuchten sind eine ideale Möglichkeit, um platzsparend Lichtspots zu setzen. Und bei der großen Auswahl an Designs und Farben ist für jeden Geschmack etwas Passendes dabei.





1004729 233



















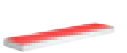





















































1004682 214

WANDLEUCHTEN

							
185	185	185	185	186	186	186	187
							
187	187	187	188	189	190	190	190
							
191	193	193	193	194	194	194	196
							
196	197	197	198	198	199	199	200
							
201	201	201	202	202	203	203	204

 205	 205	 206	 206	 207	 207	 207	 208
 208	 209	 210	 211	 211	 211	 212	 212
 213	 214	 214	 215	 216	 216	 217	 217
 217	 218	 218	 218	 219	 219	 220	 220
 221	 222	 222	 223	 224	 224	 225	 225
 226	 226	 227	 227	 228	 228	 228	 229
 230	 231	 232	 233	 233	 233	 234	 234
 235	 237	 237	 237	 238	 239	 241	 242
 242	 243	 244	 245	 245	 245		



Weitere Leuchten und Varianten finden Sie online unter www.slv.com
 Herstellerangaben unserer Leuchtmittelempfehlungen finden Sie im Kapitel Leuchtmittel ab Seite 808

1004969 + 1004660 185

1004657 + 1004663 185

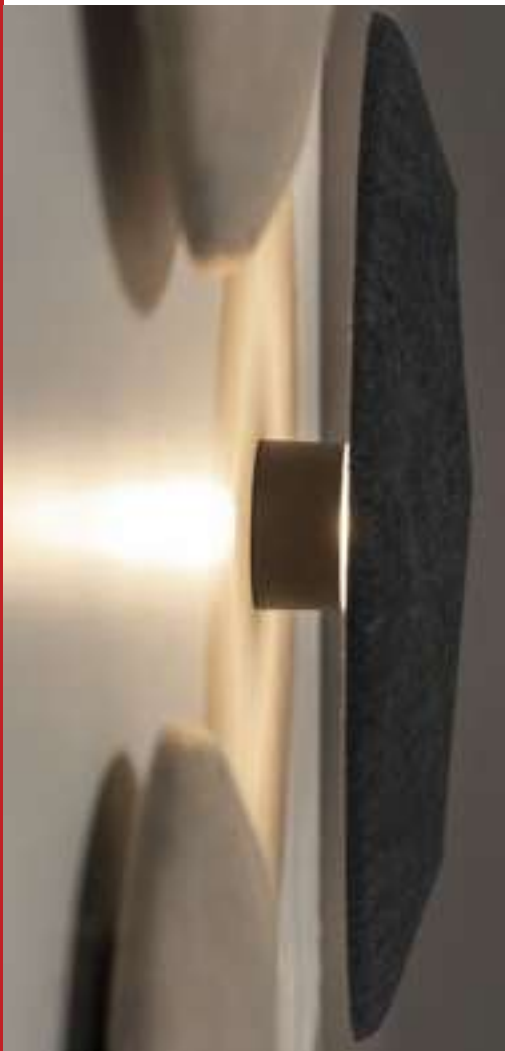

MANA BASE
WL, rund, PHASE

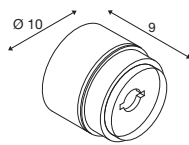
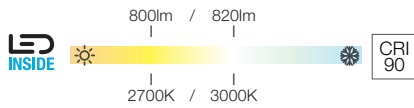
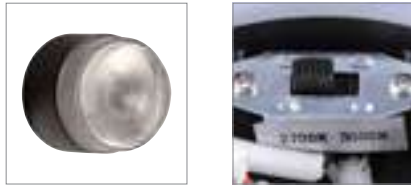

220-240V ~50/60Hz | 350mA
Systemleistung: 15W
Material: Aluminium / Polycarbonat (PC)



		A → G
1004657	800/820lm 2700/3000K	A G F

Variante	Art. Nr.
anthrazit	1004657

MANA BASE
rund

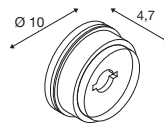

Material: Aluminium / Polycarbonat (PC)

- Unbeleuchtete Basis für runde MANA Schirme

Variante	Art. Nr.
anthrazit	1004969

MANA 40
Schirm, rund



H: 6 cm
Ø: 40 cm
Material: Filz / Aluminium

Variante	Art. Nr.
beige	1004660
grau	1004661

MANA 60
Schirm, rund



H: 6 cm
Ø: 60 cm
Material: Filz / Aluminium

Variante	Art. Nr.
beige	1004662
grau	1004663

MANA
WL, Basis, PHASE

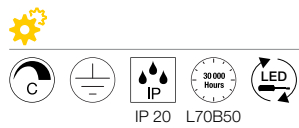
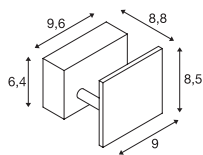
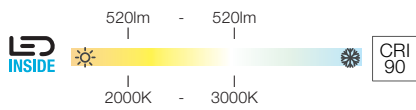

220-240V ~50/60Hz | 350mA
Systemleistung: 8,3W
Material: Aluminium / Stahl



1000613	520lm 2000-3000K	

Variante	Art. Nr.
520lm 2000-3000K CRI90 <input type="checkbox"/> weiß	1000613

MANA
Schirm



L: 12 cm H: 10 cm T: 9,0 cm
Material: Holz / Aluminium

- passend nur zu 1000613

Variante	Art. Nr.
<input checked="" type="checkbox"/> Holz grau / braun	1000616
<input type="checkbox"/> Aluminium weiß	1000618
<input type="checkbox"/> Aluminium aluminium	1000619

MANA
Schirm



B: 13,6 cm H: 10 cm T: 9,5 cm
Material: Gips / Stahl

- passend nur zu 1000613

Variante	Art. Nr.
<input type="checkbox"/> weiß	1000824

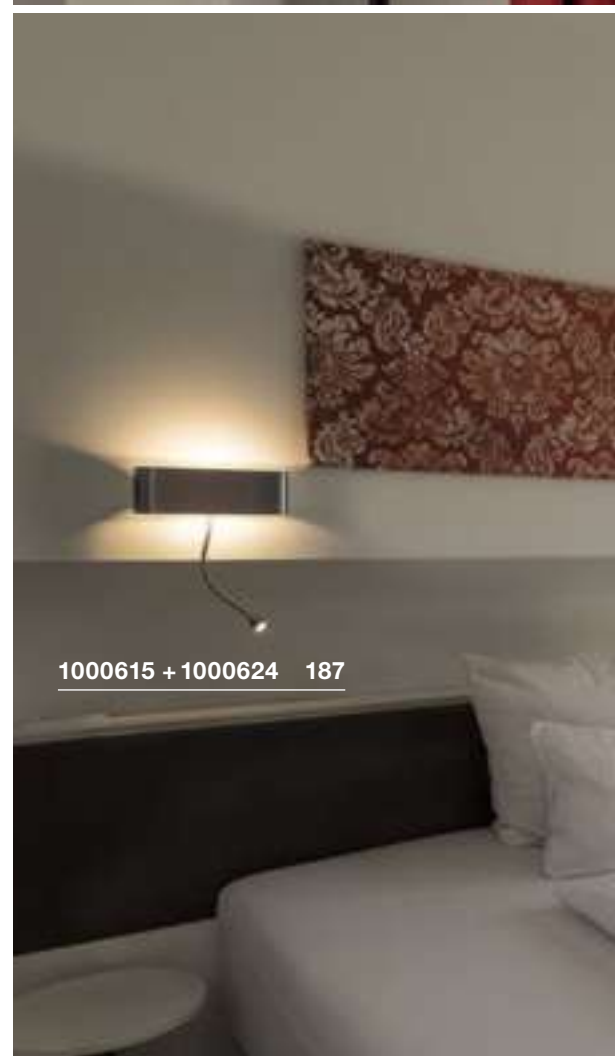
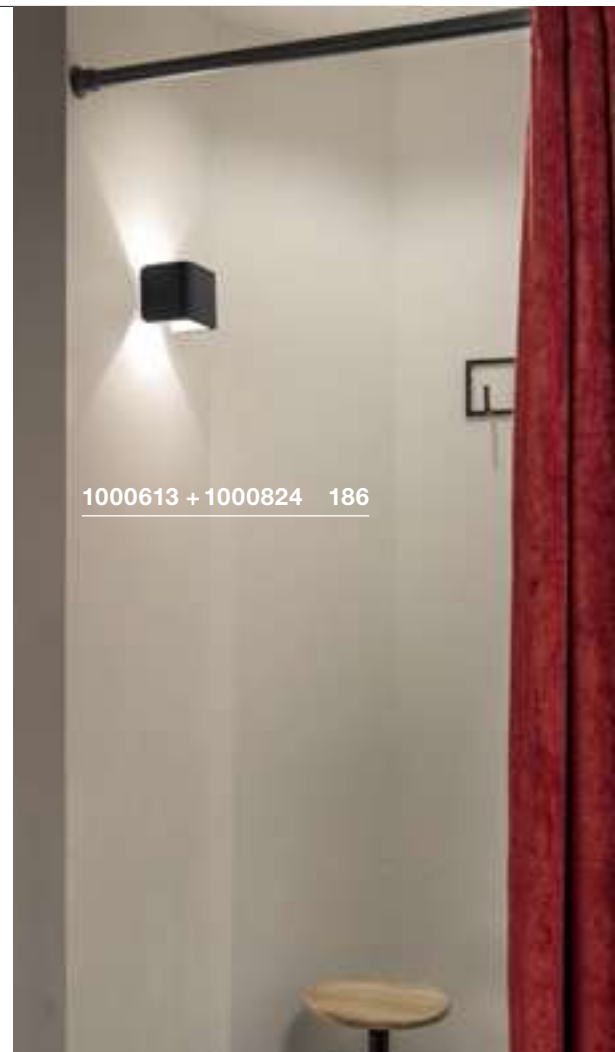

MANA
WL, Basis, PHASE

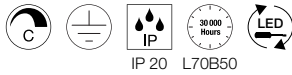
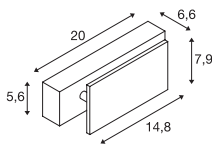
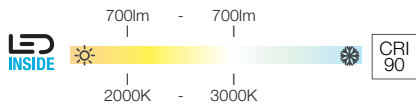

220-240V ~50/60Hz | 350mA
Systemleistung: 15W
Material: Aluminium / Stahl

MANA
WL, Basis

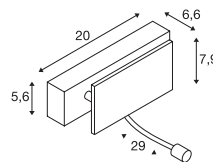
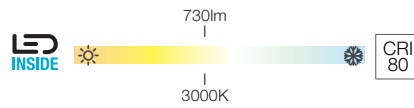

220-240V ~50/60Hz | 350/500mA
Systemleistung: 11W
Material: Aluminium / Stahl

- Spot ist getrennt schaltbar

MANA
Schirm



L: 29 cm H: 9,5 cm T: 7,0 cm
Material: Holz / Aluminium

- passend nur zu 1000614/1000615

Variante	Art. Nr.
Holz grau / braun	1000621
Aluminium weiß	1000623
Aluminium aluminium	1000624

MANA
Schirm

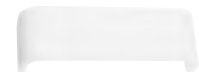

B: 30,9 cm H: 9,5 cm T: 7,4 cm
Material: Gips / Stahl

- passend nur zu 1000614/1000615



1000614	700lm 2000-3000K	A → G F
---------	---------------------	------------

Variante	Art. Nr.
700lm 2000-3000K CRI90	
weiß	1000614



Indirect	650lm 3000K	A → G E
Spot	80lm 3000K	A → G G

Variante	Art. Nr.
Indirect: 650lm 3000K CRI80	
Spot: 80lm 3000K CRI80	
weiß / chrom	1000615

Variante	Art. Nr.
weiß	1000825

OCULUS UP/DOWN
WL, PHASE

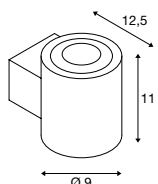
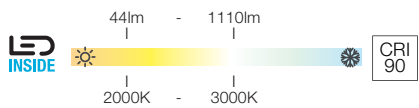

220-240V ~50/60Hz | 700mA
Systemleistung: 15W
Material: Aluminium / Glas

- Additionelle gefrostete Linse inklusive



Up/Down	22-555lm 2000-3000K	

Variante	Art. Nr.
Up: 22-555lm 2000-3000K CRI90 Down: 22-555lm 2000-3000K CRI90	
■ schwarz	1004670
Up: 22-555lm 2000-3000K CRI90 Down: 22-555lm 2000-3000K CRI90	
□ weiß	1004671

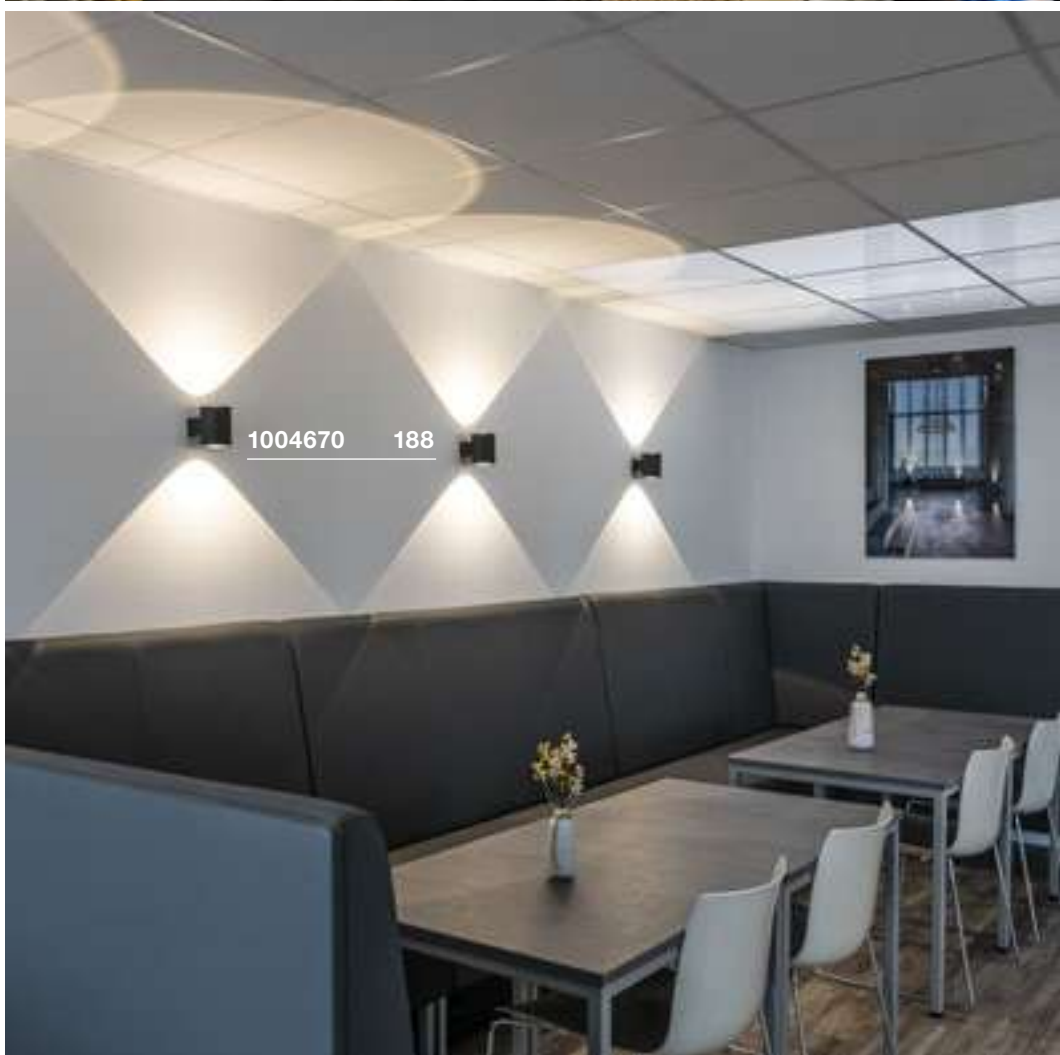



116340 189

SUPROS 78 UP/DOWN
WL, PHASE

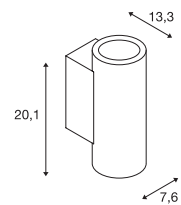
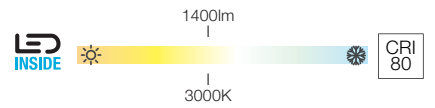
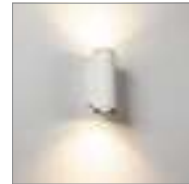

220-240V ~50/60Hz | 500mA
Systemleistung: 20W
Material: Aluminium

		A → G
Up/Down	700lm 3000K	A G → E

-
- Linse 20°
Art. Nr. 116302
 - Linse 40°
Art. Nr. 116304

Variante	Art. Nr.
Up: 700lm 3000K CRI80 Down: 700lm 3000K CRI80	
<input checked="" type="checkbox"/> schwarz	116340
Up: 700lm 3000K CRI80 Down: 700lm 3000K CRI80	
<input type="checkbox"/> weiß	116341

PLASTRA
WL, Cube, QT14



PLASTRA
WL, cubes

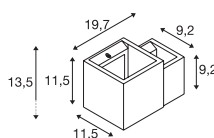
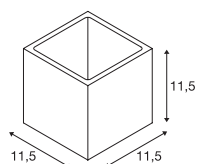
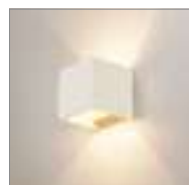
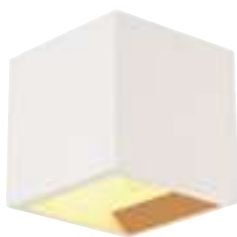

220-240V ~50/60Hz
Material: Gips / Stahl

220-240V ~50/60Hz
Material: Gips / Stahl



G9 <42W



G9 15W
Ø: 7 cm L: 4 cm



LED G9 | 3,6W | 300°
3000K | 400lm | EEK=E
4kWh/1000h



Art. Nr. 1005286



LED G9 | 3,6W | 300°
3000K | 400lm | EEK=E
4kWh/1000h



Art. Nr. 1005286

Variante	Art. Nr.
1xG9 □ weiß	148018

Variante	Art. Nr.
2xG9 □ weiß	1004733

148018 190





1002238 191



148010 191

PLASTRA
WL, rechteckig, QT-DE12



PLASTRA
WL, E14

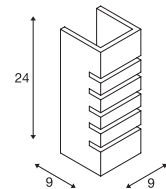
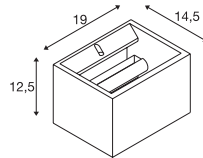
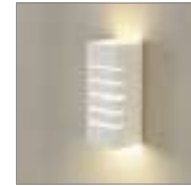

IP 20

220-240V ~50/60Hz
Material: Gips / Stahl



IP 20

220-240V ~50/60Hz
Material: Gips / Stahl



R7s 118mm <20W



LED R7s | 15W | 330°
3000K | 2000lm | EEK=E
15kWh/1000h

Art. Nr. 1005288



E14 <40W



C35 | 4.2W | 320°
2700K | 350lm | EEK=G
5kWh/1000h

Art. Nr. 1005285



Variante	Art. Nr.
1xR7s 118mm	
<input type="checkbox"/> weiß	1002238

Variante	Art. Nr.
1xE14	
<input type="checkbox"/> weiß	148010

148060 193



148091 193



1004732 193



PLASTRA
WL, halbrund

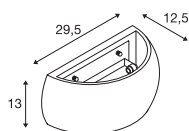

220-240V ~50/60Hz
Material: Gips / Stahl



R7s 118mm 20W
Ø: 2 cm L: 11,8 cm



LED R7s | 15W | 330°
3000K | 2000lm | EEK=E
15kWh/1000h



Art. Nr. 1005288

Variante	Art. Nr.
1xR7s 118mm □ weiß	1004732

PLASTRA
CW, rund

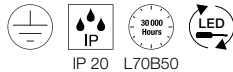
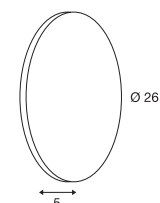

100-240V ~50/60Hz | 12V
Systemleistung: 6,5W
Material: Gips / Stahl



148091	375lm 3000K	A → G F
--------	----------------	------------

Variante	Art. Nr.
375lm 3000K CRI80 □ weiß	148091

PLASTRA
WL, QPAR51

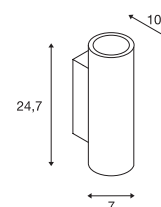
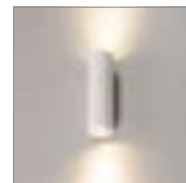

220-240V ~50/60Hz
Material: Gips / Stahl



GU10 <35W



LED GU10 51mm | 4W | 36°
2700K | 270lm | EEK=G
4kWh/1000h



Art. Nr. 1004972

Variante	Art. Nr.
2xGU10 □ weiß	148060

PLASTRA 101
WL, E14



PLASTRA
WL, Curve, QT-DE12

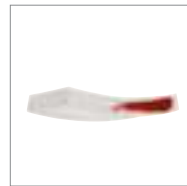

PLASTRA 104
WL, QT14

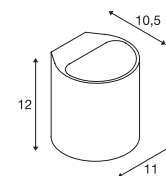
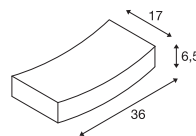
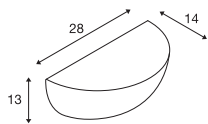

230V ~50Hz
Material: Gips / Stahl



230V ~50Hz
Material: Gips / Stahl



220-240V ~50/60Hz
Material: Gips / Stahl



E14 <40W
Ø: 4,5 cm L: 11 cm



R7s 78mm <100W



G9 <42W



LED E14 | 4,2W | 320°
2700K | 370lm | EEK=F
4kWh/1000h



Art. Nr. 1005284



LED R7s | 9W | 330°
3000K | 1050lm | EEK=E
9kWh/1000h



Art. Nr. 1005287

Variante	Art. Nr.
1xE14	
<input type="checkbox"/> weiß	148013

Variante	Art. Nr.
1xR7s 78mm	
<input type="checkbox"/> weiß	148012

Variante	Art. Nr.
1xG9	
<input type="checkbox"/> weiß	148016



148012 194



148013 194

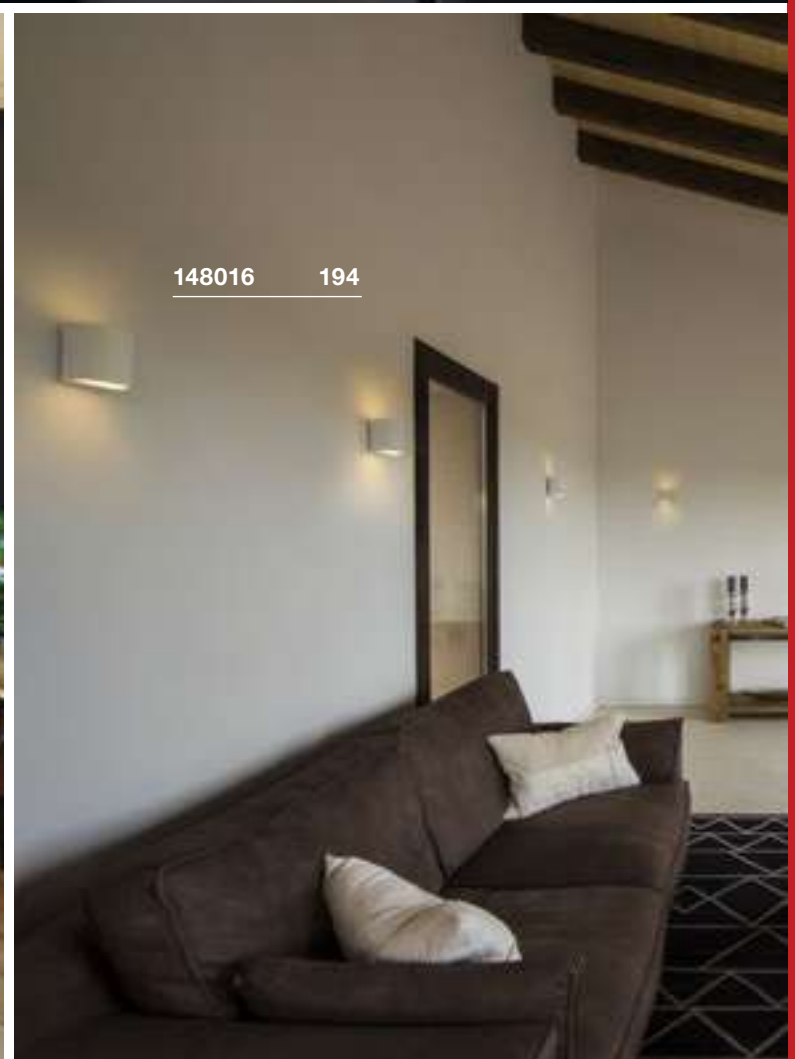

148016 194

LOGS IN
WL



LOGS IN
WL, PHASE

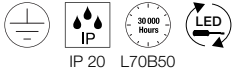
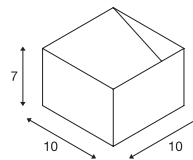
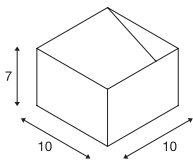
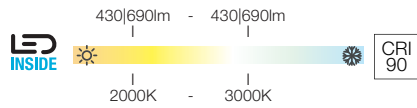
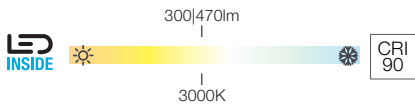
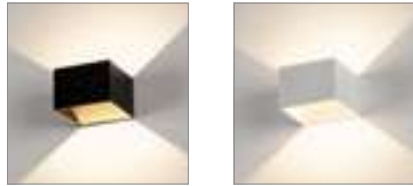
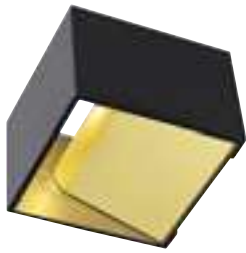

100-240V ~50/60Hz | 500mA
Systemleistung: 6W
Material: Aluminium

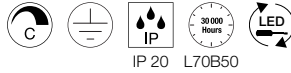

220-240V ~50/60Hz | 250mA
Systemleistung: 11W
Material: Aluminium



151325 196



151320, 151321, 151325	300lm 470lm 3000K	



1000638, 1000639, 1000640	430lm 690lm 2000-3000K	

Variante	Art. Nr.
300lm 3000K CRI90 ■ schwarz / gold	151320
470lm 3000K CRI90 □ weiß	151321
470lm 3000K CRI90 ■ aluminium / weiß	151325

Variante	Art. Nr.
430lm 2000-3000K CRI90 ■ schwarz / gold	1000638
690lm 2000-3000K CRI90 □ weiß	1000639
690lm 2000-3000K CRI90 ■ aluminium / weiß	1000640

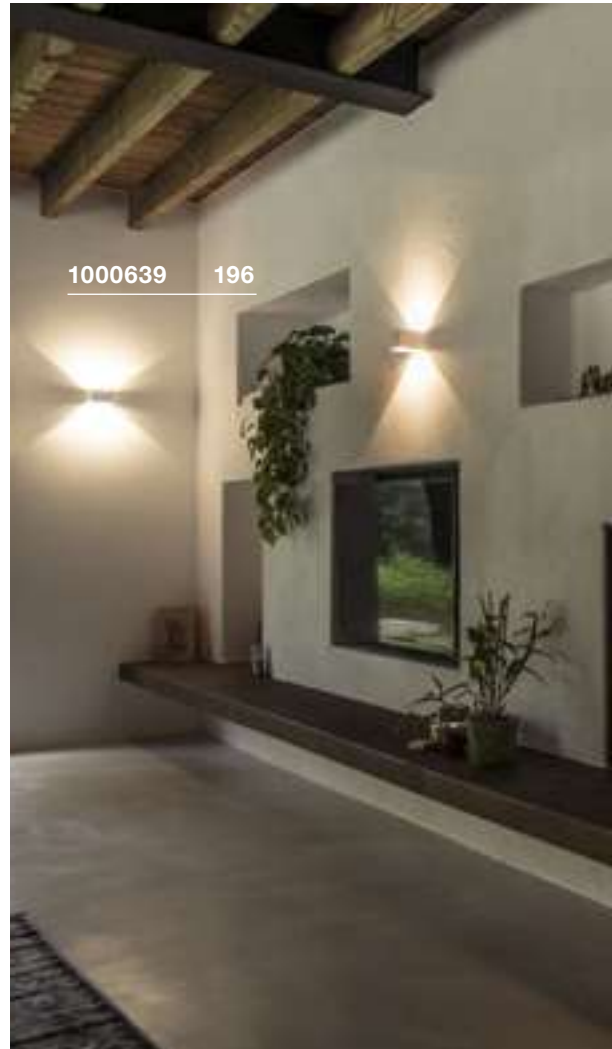

1000639 196



1002928 197

LOGS IN L
WL, PHASE

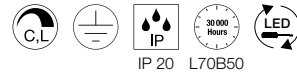
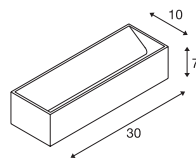
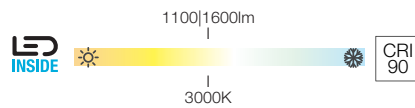

220-240V ~50/60Hz | 500mA
Systemleistung: 18W
Material: Aluminium

LOGS IN L
WL, PHASE

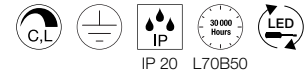
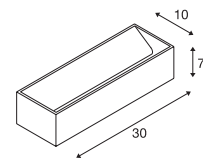
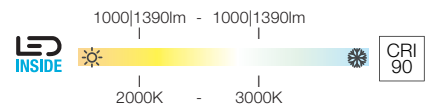

220-240V ~50/60Hz | 500mA
Systemleistung: 21W
Material: Aluminium



1002842, 1002843, 1002844	1100lm 1600lm 3000K	

Variante	Art. Nr.
1100lm 3000K CRI90	
schwarz / gold	1002842
1600lm 3000K CRI90	
weiß	1002844
1600lm 3000K CRI90	
aluminium / weiß	1002843



1002928, 1002929, 1002930	1000lm 1390lm 2000-3000K	

Variante	Art. Nr.
1000lm 2000-3000K CRI90	
schwarz / gold	1002928
1390lm 2000-3000K CRI90	
weiß	1002929
1390lm 2000-3000K CRI90	
aluminium / weiß	1002930

QUAD FRAME 14
WL



130lm / 165lm

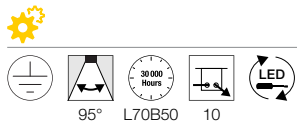
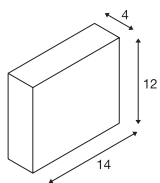

100-277V ~50/60Hz | 350mA
Systemleistung: 4W
Material: Aluminium

QUAD FRAME 19
WL



540lm / 640lm

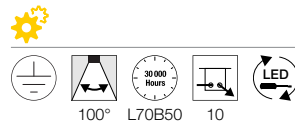
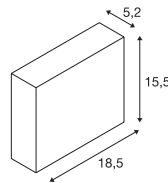

100-240V ~50/60Hz | 500mA
Systemleistung: 11W
Material: Aluminium



1000422 199

1003467	130/165lm 2700/3000K	

Variante **Art. Nr.**
130/165lm | 2700/3000K | CRI90
 weiß **1003467**

1003468	540/640lm 2700/3000K	

Variante **Art. Nr.**
540/640lm | 2700/3000K | CRI90
 weiß **1003468**



1003467 198

SHELL 15
WL, PHASE

SHELL 30
WL, PHASE

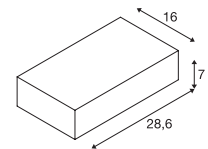
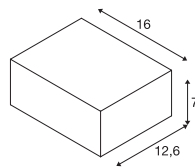
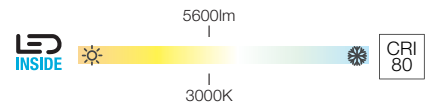
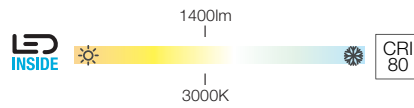

IP 20 IK02 120° L70B50

IP 20 IK02 120° L70B50

220-240V ~50/60Hz | 350mA
Systemleistung: 15W
Material: Aluminium / Acryl

220-240V ~50/60Hz | 700mA
Systemleistung: 54W
Material: Aluminium / Acryl



1000423 199

1000422	1400lm 3000K	

1000423	5600lm 3000K	

Variante **Art. Nr.**
1400lm | 3000K | CRI80
 weiß **1000422**

Variante **Art. Nr.**
5600lm | 3000K | CRI80
 weiß **1000423**

ASSO 70
WL

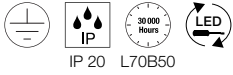
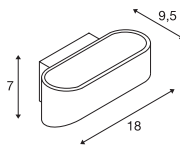
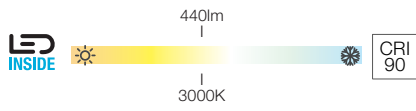

100-240V ~50/60Hz | 500mA
Systemleistung: 6W
Material: Aluminium / Stahl



151311, 151315	440lm 3000K	A → G A ↑ G ↓ E
-------------------	----------------	-----------------------

Variante	Art. Nr.
440lm 3000K CRI90 □ weiß	151311
440lm 3000K CRI90 ■ aluminium / weiß	151315

1000636 201



1000635 201



ASSO
WL, PHASE

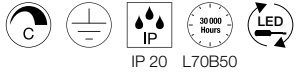
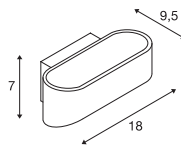
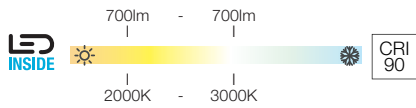

220-240V ~50/60Hz | 250mA
Systemleistung: 11W
Material: Aluminium / Stahl

ASSO 300
WL, PHASE

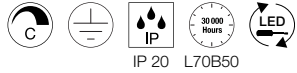
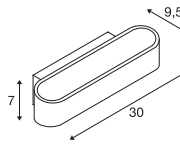
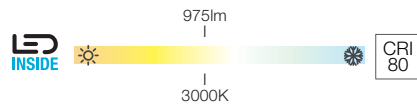
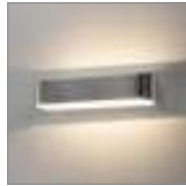

220-240V ~50/60Hz | 500mA
Systemleistung: 12W
Material: Aluminium / Stahl

ASSO 300
WL, PHASE

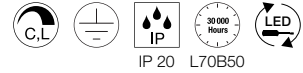
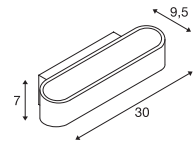
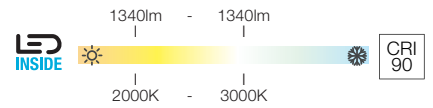

220-240V ~50/60Hz | 500mA
Systemleistung: 21W
Material: Aluminium / Stahl



1000636, 1000637	700lm 2000-3000K	

Variante	Art. Nr.
700lm 2000-3000K CRI90	
weiß	1000636
700lm 2000-3000K CRI90	
aluminium / weiß	1000637



151271, 151275	975lm 3000K	

Variante	Art. Nr.
975lm 3000K CRI80	
weiß	151271
975lm 3000K CRI80	
aluminium / weiß	151275



1000634, 1000635	1340lm 2000-3000K	

Variante	Art. Nr.
1340lm 2000-3000K CRI90	
weiß	1000634
1340lm 2000-3000K CRI90	
aluminium / weiß	1000635

OSSA 180
WL, QT-DE12

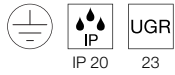
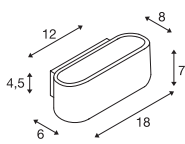

230V ~50Hz
Material: Aluminium / Stahl

OSSA 300
WL, QT-DE12

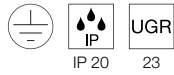
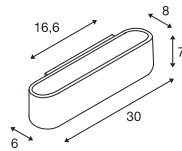
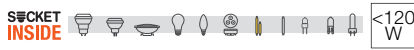

230V ~50Hz
Material: Aluminium / Stahl



R7s 78mm <100W



LED R7s | 9W | 330°
3000K | 1050lm | EEK=E
9kWh/1000h



Art. Nr. 1005287



R7s 118mm <120W



LED R7s | 15W | 330°
3000K | 1960lm | EEK=E
15kWh/1000h



Art. Nr. 1005288

Variante	Art. Nr.
1xR7s 78mm	
■ schwarz	151450
1xR7s 78mm	
□ weiß	151451
1xR7s 78mm	
▒ aluminium	151456

Variante	Art. Nr.
1xR7s 118mm	
■ schwarz	151410
1xR7s 118mm	
□ weiß	151411
1xR7s 118mm	
▒ aluminium	151416



151710 203



151740 203

CARISO
WL, PHASE

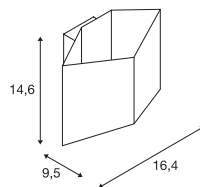
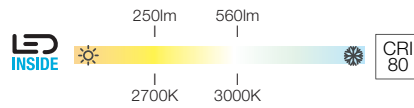
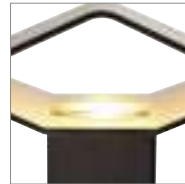

220-240V ~50/60Hz | 500mA
Systemleistung: 9,2W
Material: Aluminium / Stahl

CARISO
WL, PHASE

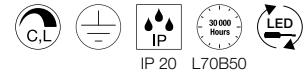
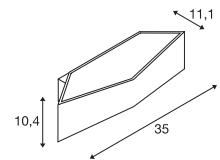
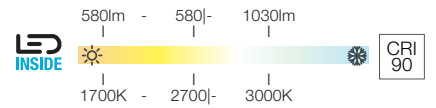
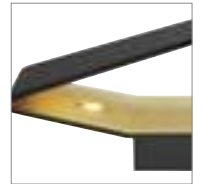

220-240V ~50/60Hz | 500mA
Systemleistung: 21W
Material: Aluminium / Stahl



151710, 151711	250lm 560lm 2700 3000K	

Variante	Art. Nr.
250lm 2700K CRI80 ■ schwarz / gold	151710
560lm 3000K CRI80 □ weiß	151711



151740, 151741	580lm 1030lm 1700-2700 2000-3000K	

Variante	Art. Nr.
580lm 1700-2700K CRI90 ■ schwarz / gold	151740
1030lm 2000-3000K CRI90 □ weiß	151741

CHROMBO
WL, PHASE

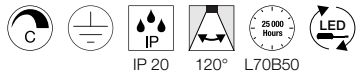
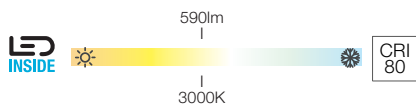

220-240V ~50/60Hz | 350mA
Systemleistung: 11W
Material: Stahl / Glas



1003317 218



1003316, 1003317	590lm 3000K	

Variante	Art. Nr.
590lm 3000K CRI80 □ glänzend weiß	1003316
590lm 3000K CRI80 ■ gebürstet grau	1003317



149511 205



149511 205

WL 149
WL, PHASE

WL 149
WL, QT-DE12

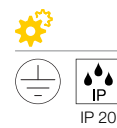
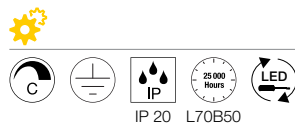
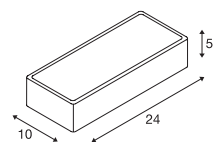
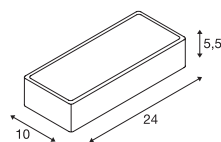
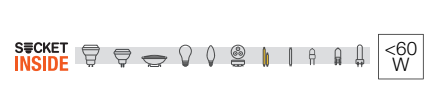
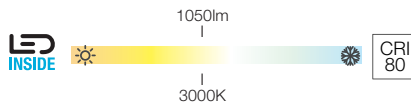

220-240V ~50/60Hz | 350mA
Systemleistung: 14W
Material: Stahl / Glas

220-240V ~50/60Hz
Material: Stahl / Glas

149511	1050lm 3000K	

	R7s 78mm <60W
	LED R7s 9W 330° 3000K 1050lm EEK=E 9kWh/1000h

Art. Nr. 1005287

Variante	Art. Nr.
1050lm 3000K CRI80	
<input type="checkbox"/> weiß	149511

Variante	Art. Nr.
R7s 78mm	
<input type="checkbox"/> weiß	149471

DIRETO 60
WL, PHASE

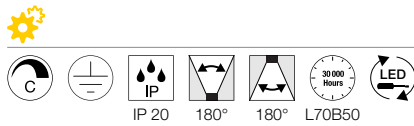
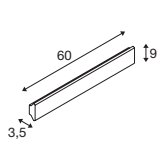
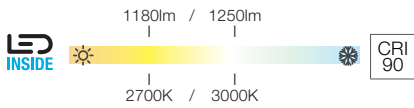

220-240V ~50/60Hz | 500mA
Systemleistung: 14W
Material: Aluminium

DIRETO 90
WL, PHASE

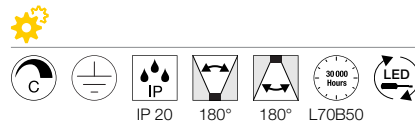
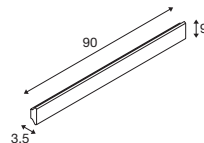
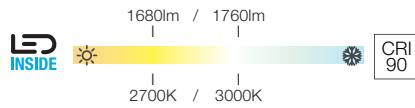
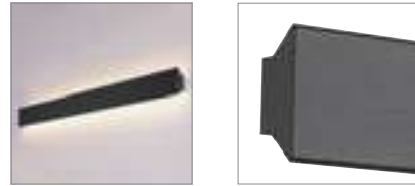

220-240V ~50/60Hz | 500mA
Systemleistung: 20W
Material: Aluminium

Up/Down	590/625lm 2700/3000K	

Variante	Art. Nr.
Up: 590/625lm 2700/3000K CRI90 Down: 590/625lm 2700/3000K CRI90	
■ schwarz	1004740
Up: 590/625lm 2700/3000K CRI90 Down: 590/625lm 2700/3000K CRI90	
□ weiß	1004741

Up/Down	840/880lm 2700/3000K	

Variante	Art. Nr.
Up: 840/880lm 2700/3000K CRI90 Down: 840/880lm 2700/3000K CRI90	
■ schwarz	1004742
Up: 840/880lm 2700/3000K CRI90 Down: 840/880lm 2700/3000K CRI90	
□ weiß	1004743

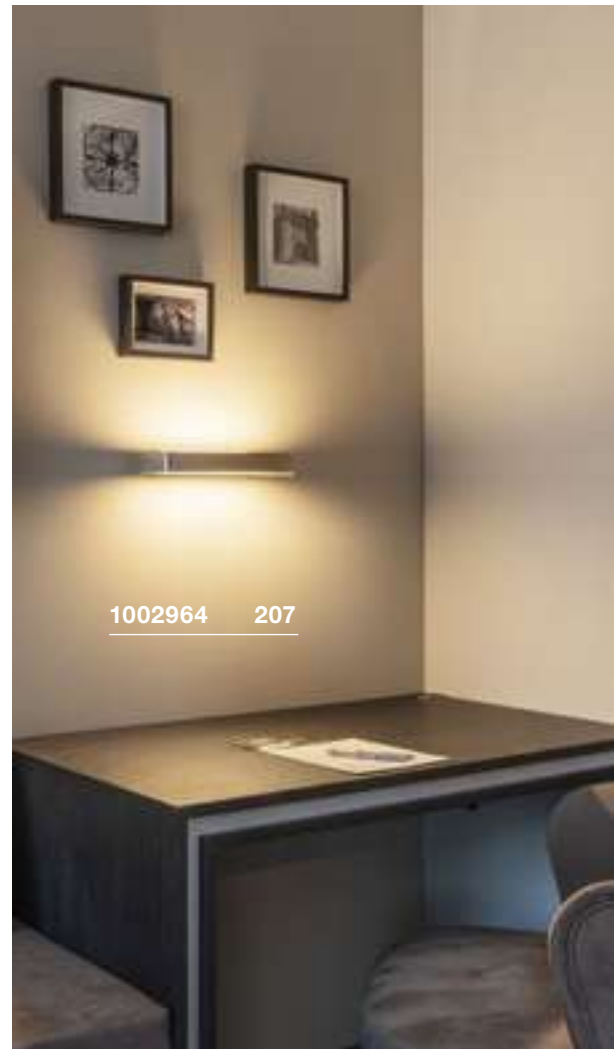

SEDO 7
WL

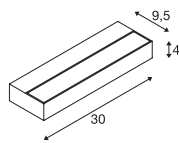
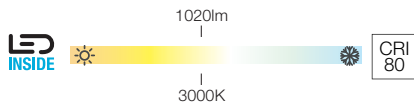
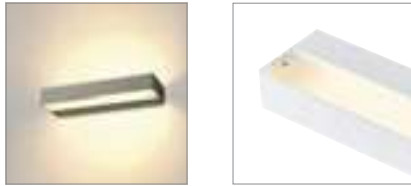

220-240V ~50/60Hz | 350mA
Systemleistung: 11,5W
Material: Aluminium / Glas

SEDO 14
WL

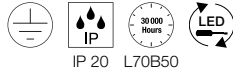
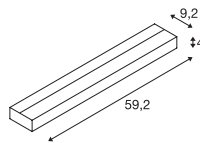
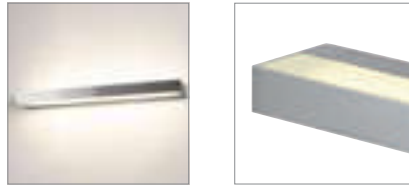

220-240V ~50/60Hz | 500mA
Systemleistung: 16W
Material: Aluminium / Glas

SEDO 21
WL

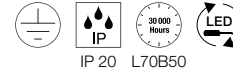
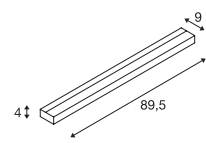
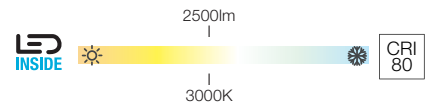
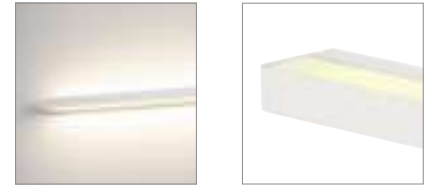

220-240V ~50/60Hz | 700mA
Systemleistung: 30W
Material: Aluminium / Glas



1002962, 1002964	1020lm 3000K	

Variante	Art. Nr.
1020lm 3000K CRI80 <input type="checkbox"/> weiß	1002962
1020lm 3000K CRI80 <input checked="" type="checkbox"/> aluminium	1002964



151781, 151786	1300lm 3000K	

Variante	Art. Nr.
1300lm 3000K CRI80 <input type="checkbox"/> weiß	151781
1300lm 3000K CRI80 <input checked="" type="checkbox"/> aluminium	151786



151791, 151796	2500lm 3000K	

Variante	Art. Nr.
2500lm 3000K CRI80 <input type="checkbox"/> weiß	151791
2500lm 3000K CRI80 <input checked="" type="checkbox"/> aluminium	151796

ARLINA 60
WL

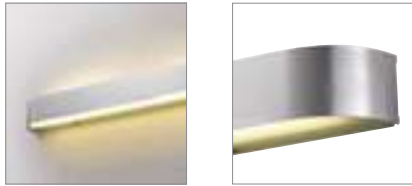

1550lm
3000K

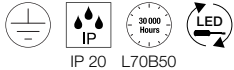
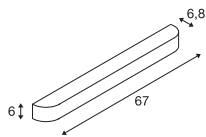

220-240V ~50/60Hz | 500mA
Systemleistung: 23W
Material: Aluminium / Glas

ARLINA 130
WL

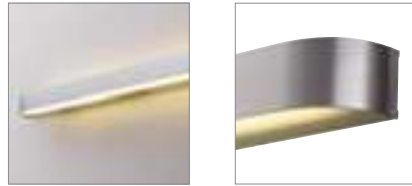
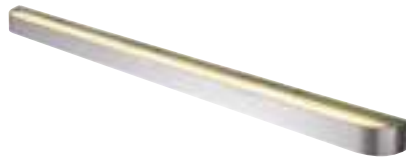

2400lm
3000K

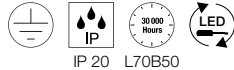
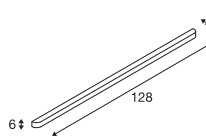

220-240V ~50/60Hz | 700mA
Systemleistung: 28W
Material: Aluminium / Glas



1002239	1550lm 3000K	

Variante **Art. Nr.**
1550lm | 3000K | CRI80
 aluminium **1002239**



1002240	2400lm 3000K	

Variante **Art. Nr.**
2400lm | 3000K | CRI90
 aluminium **1002240**



1002240 208



1003023 209

NEW FLAT
WL, RGB-W

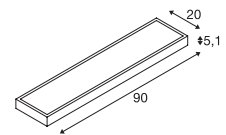
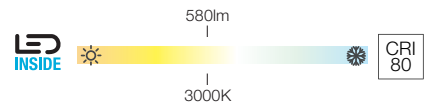
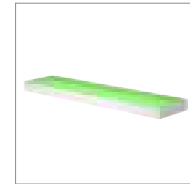

IP 20 110° 110° L70B50

220-240V ~50/60Hz | 24V
Systemleistung: 11,3W
Material: Aluminium / Acryl

- steuerbar mit Gateway Art-Nr. 1002411 oder Fernbedienung Art-Nr. 1002994



Up	300lm	3000K	
Down	280lm	3000K	

Variante	Art. Nr.
Up: RGB-W (300lm 3000K CRI>80) Down: RGB-W (280lm 3000K CRI>80)	weiß 1003022
Up: RGB-W (300lm 3000K CRI>80) Down: RGB-W (280lm 3000K CRI>80)	aluminium 1003023

ANDREAS
WL, QT-DE12

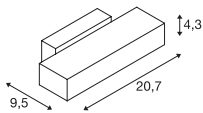
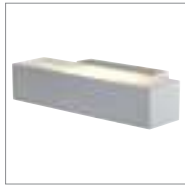

220-240V ~50/60Hz
Material: Aluminium / Stahl



R7s 118mm <80W



LED R7s | 15W | 330°
3000K | 2000lm | EEK=E
15kWh/1000h



Art. Nr. 1005288

Variante	Art. Nr.
1xR7s 118mm	
■ schwarz	1002927
1xR7s 118mm	
□ weiß	1002925
1xR7s 118mm	
■ grau	1002926

1002926 210

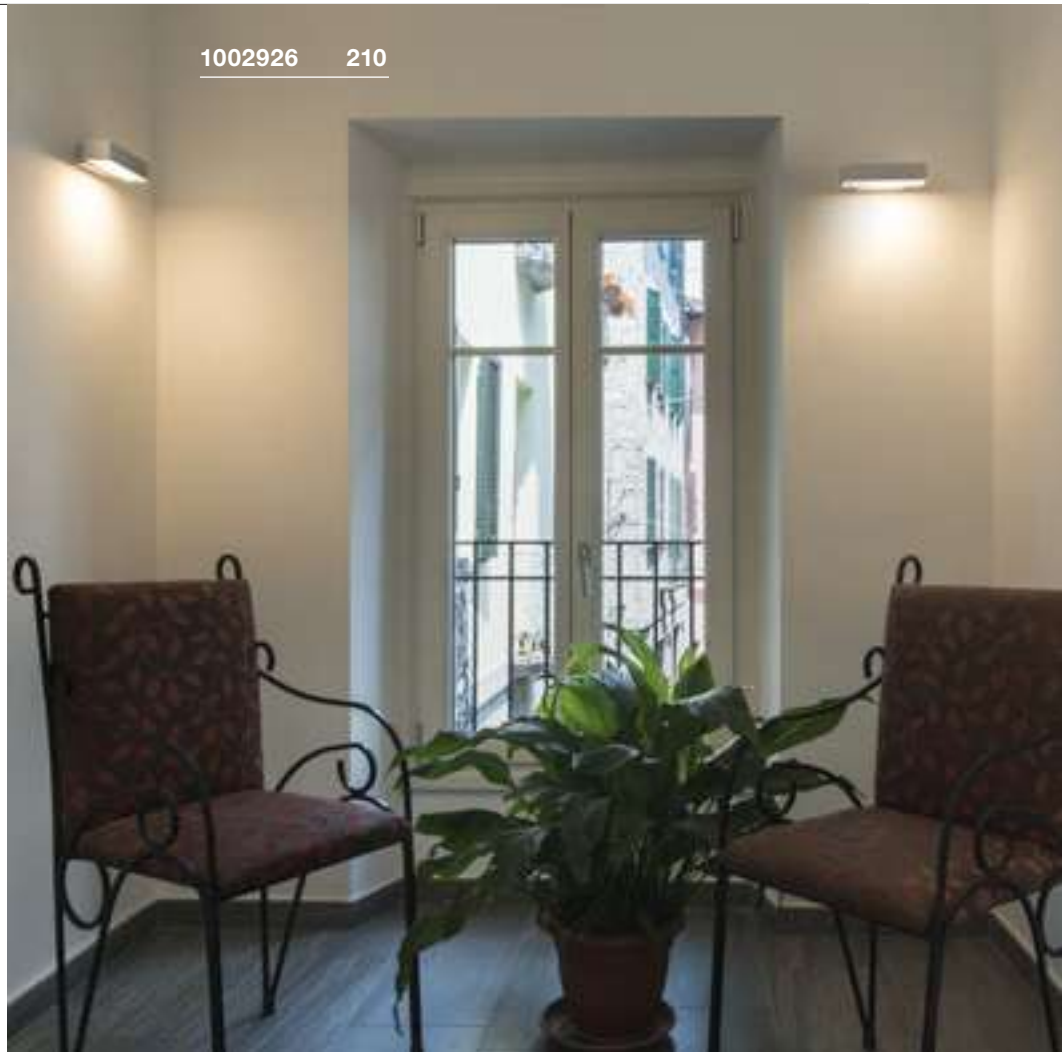

151591 211



DENA 30
WL, E14

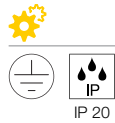
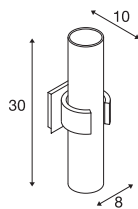

220-240V ~50/60Hz
Material: Aluminium / Glas

LED E14 <40W
Ø: 5 cm L: 9,6 cm

LED E14 | 4,2W | 320°
2700K | 370lm | EEK=F
4kWh/1000h

Art. Nr. 1005284

Variante	Art. Nr.
2xE14 weiß / aluminium	147529

BASKET
WL, E27

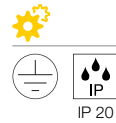
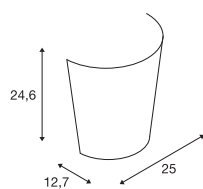

230V ~50Hz
Material: Aluminium / Glas

LED E27 <60W
Ø: 5,2 cm L: 15,2 cm

LED E27 | 8W | 240°
4000K | 880lm | EEK=E
8kWh/1000h

Art. Nr. 1005290

Variante	Art. Nr.
1xE27 weiß	151591

PURISA
WL, E27

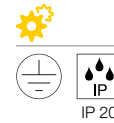
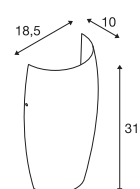

220-240V ~50/60Hz
Material: Stahl / Glas

LED E27 <40W
Ø: 8 cm L: 15 cm

LED E27 | 9W | 220°
2700K | 800lm | EEK=F
9kWh/1000h

Art. Nr. 1005301

Variante	Art. Nr.
1xE27 weiß	1002993

QUADRASS
WL, E27



QUADRASS SPOT
WL, E27

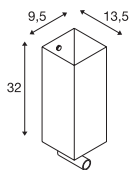
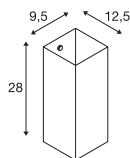

220-240V ~50/60Hz
Material: Stahl / Glas

100-240V ~50/60Hz | 700mA
Systemleistung: 2W
Material: Stahl / Glas



E27 <40W
Ø: 6,5 cm L: 18 cm



E27 <40W
Ø: 6,5 cm L: 18 cm



LED E27 | 9W | 220°
2700K | 800lm | EEK=F
9kWh/1000h



Art. Nr. 1005301



LED E27 | 8W | 240°
3000K | 880lm | EEK=E
8kWh/1000h



Art. Nr. 1005289

Variante	Art. Nr.
1xE27	
■ schwarz	1003430
1xE27	
□ weiß	1003431

Variante	Art. Nr.
1xE27	
200lm 3000K CRI80	
■ schwarz / milchig	1003428
1xE27	
200lm 3000K CRI80	
□ weiß / milchig	1003429

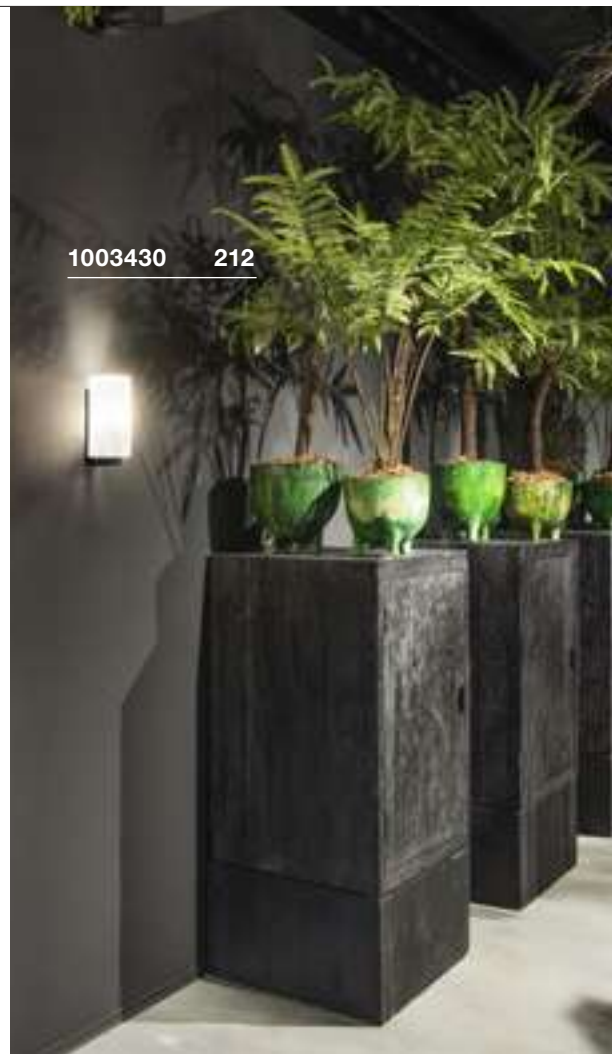

1003430 212





155752 213

LISENNE
WL, E27



SOCKET INSIDE <23 W

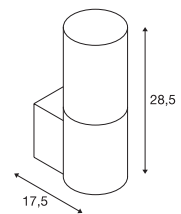

220-240V ~50/60Hz
Material: Basalt / Glas



1003428 212



E27 <23W
Ø: 5,9 cm L: 15 cm



LED E27 | 7,5W | 320°
2700K | 800lm | EEK=F
8kWh/1000h



Art. Nr. 1005268

Variante	Art. Nr.
1xE27	
■ grau / braun	155752

FITU
Wandhalter

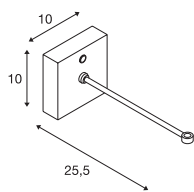
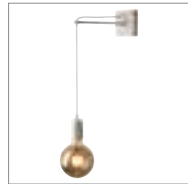

Material: Stahl

FITU
WL, E27

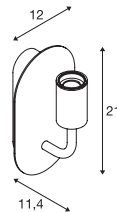

<24
W



220-240V ~50/60Hz
Material: Aluminium / Stahl



E27 <24W



LED E27 | 7,5W | 320°
2500K | 700lm | EEK=F
8kWh/1000h



Art. Nr. 1005265

Variante	Art. Nr.
■ schwarz	1004682
□ weiß	1004683

Variante	Art. Nr.
1xE27	
■ schwarz	1002148
1xE27	
□ weiß	1002147
1xE27	
■ gold	1002149

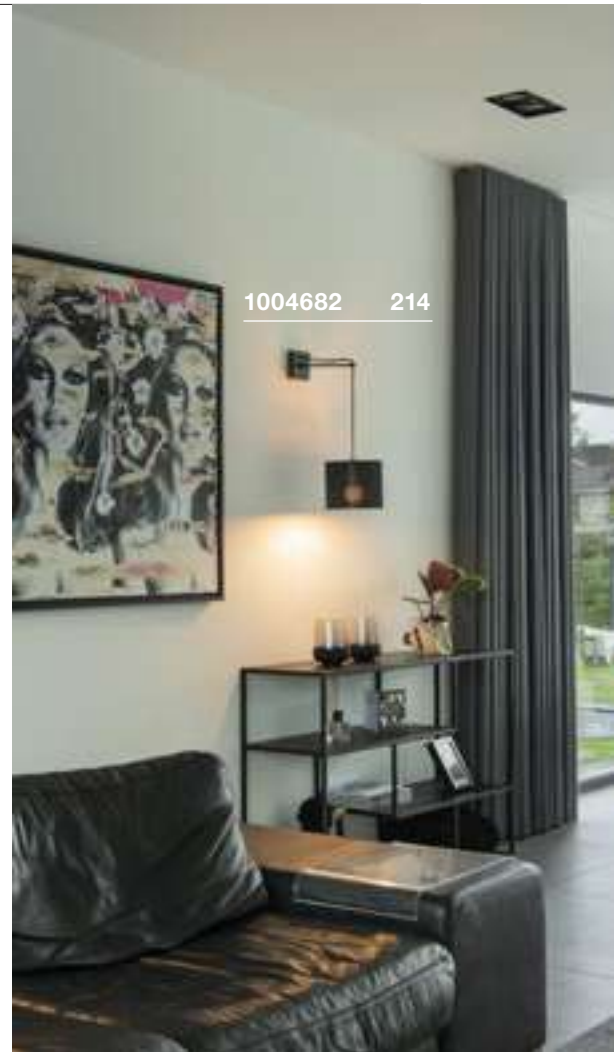

1004682 214

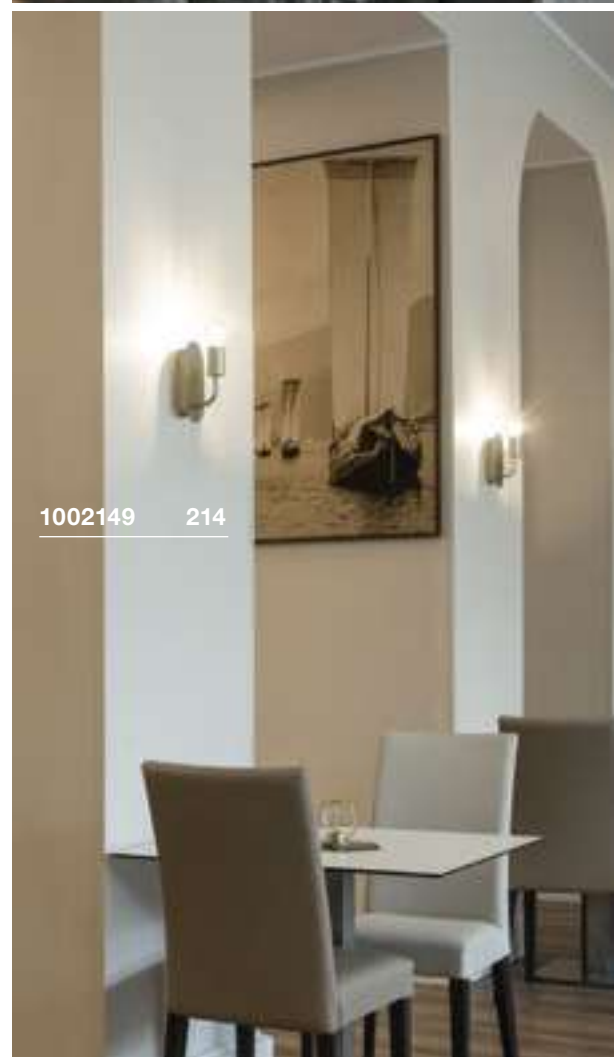

1002149 214



1004738 215

FITU CUBE
WL, E27

SOCKET INSIDE <20 W

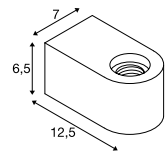

IP 20

220-240V ~50/60Hz
Material: Stahl



E27 <20W
Ø: 12,5 cm



LED E27 | 7,5W | 320°
2700K | 800lm | EEK=E
8kWh/1000h



Art. Nr. 1005309

Variante	Art. Nr.
1xE27	
■ schwarz	1004738
1xE27	
□ weiß	1004739

THEO UP/DOWN
WL, QPAR51



<50 W

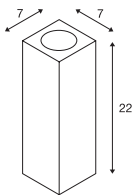

230V ~50Hz
Material: Aluminium



GU10 <50W



LED GU10 51mm | 4W | 36°
3000K | 280lm | EEK=F
4kWh/1000h



Art. Nr. 1004973

Variante	Art. Nr.
2xGU10	
■ anthrazit	1000330
2xGU10	
□ weiß	1000327
2xGU10	
■ aluminium	1000329

SOLID CUBE
WL, QT14



<25 W

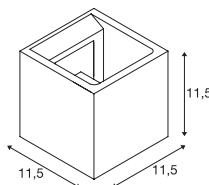

230V ~50Hz
Material: Beton



G9 <25W



LED G9 | 3,6W | 300°
3000K | 400lm | EEK=E
4kWh/1000h



Art. Nr. 1005286

Variante	Art. Nr.
1xG9	
■ schwarz	1000911
1xG9	
■ grau	1000910



1000910 216



1000731 217



151803 217

ENOLA B
WL, QPAR51

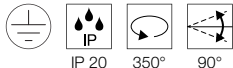
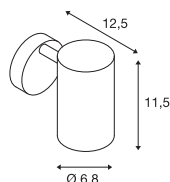

230V ~50Hz
Material: Aluminium / Stahl

ENOLA B
WL, QPAR51

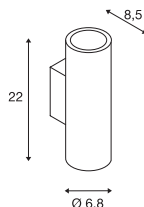

220-240V ~50/60Hz
Material: Aluminium / Stahl

ASTINA UP/DOWN
WL, QPAR51

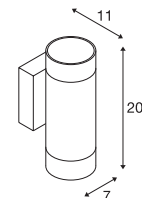

220-240V ~50/60Hz
Material: Aluminium / Stahl



GU10 <50W L: 6 cm



LED GU10 51mm | 6W | 36°
2200-2700K | 360lm | EEK=G
6kWh/1000h



Art. Nr. 1005273



Zierring, schwarz
Art. Nr. 151840



Variante	Art. Nr.
1xGU10	
■ schwarz	1000729
1xGU10	
□ weiß	1000730
1xGU10	
■ gold	1000731



GU10 <50W L: 8,5 cm



LED GU10 51mm | 4W | 36°
3000K | 280lm | EEK=F
4kWh/1000h



Art. Nr. 1004973



Zierring, schwarz
Art. Nr. 151840



Variante	Art. Nr.
2xGU10	
■ schwarz	151800
2xGU10	
□ weiß	151801
2xGU10	
■ gold	151803
2xGU10	
■ grau	151804



GU10 <10W



LED GU10 51mm | 4W | 36°
4000K | 290lm | EEK=F
4kWh/1000h



Art. Nr. 1004974



Zierring, schwarz
Art. Nr. 151840



Variante	Art. Nr.
2xGU10	
■ schwarz	1002933
2xGU10	
□ weiß	1002931
2xGU10	
■ grau	1002932

FENDA
WL, Basis, E27

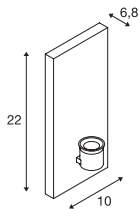

220-240V ~50/60Hz
Material: Stahl / Kunststoff



E27 <40W
Ø: 5 cm L: 20 cm



LED E27 | 8W | 240°
3000K | 880lm | EEK=E
8kWh/1000h



Art. Nr. 1005289

Variante	Art. Nr.
1xE27	
□ weiß	1001272

FENDA
Halbschirm



B: 23 cm H: 30,5 cm T: 11,5 cm
Material: Textil / Stahl

• max. 25W

Variante	Art. Nr.
■ schwarz	1001273
■ schwarz / kupfer	1001274
□ weiß	1001275
■ beige	1001276

FENDA
Ø 20 cm, rund



Material: Textil / Stahl

• max. 40W

Variante	Art. Nr.
■ schwarz	1001451 ▼
■ schwarz / kupfer	1001452 ▼
□ weiß	1001453 ▼
■ beige	1001454 ▼





1001450 + 1001452 218 + 219



1001272 + 1001273 218

FENDA
WL, Basis, E27



FENDA
WL, E27



SOCKET INSIDE <40 W

SOCKET INSIDE <40 W

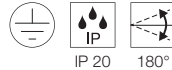
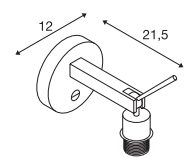
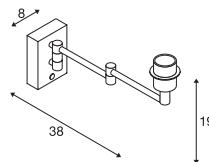

230V ~50Hz
Material: Stahl

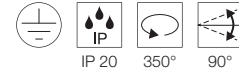

220-240V ~50/60Hz
Material: Stahl / Aluminium



E27 <40W L: 12 cm



E27 <40W



LED E27 | 7,5W | 320°
2700K | 800lm | EEK=F
8kWh/1000h



Art. Nr. 1005303



LED E27 | 9W | 220°
2700K | 800lm | EEK=F
9kWh/1000h



Art. Nr. 1005301

Variante	Art. Nr.
1xE27	
■ schwarz	1001450 ▼
1xE27	
■ chrom	1001449 ▼

Variante	Art. Nr.
1xE27	
■ schwarz	1003034 ▼
1xE27	
□ weiß	1003035 ▼

KENKUA SPOT
WL, E27

KENKUA
WL, E27

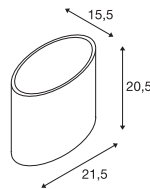
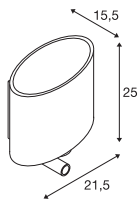
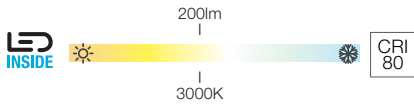
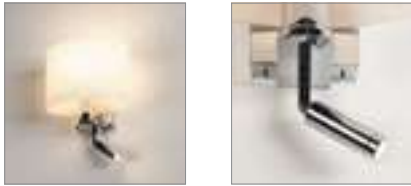

220-240V ~50/60Hz
Material: Stahl / Glas

100-240V ~50/60Hz | 700mA
Systemleistung: 2W
Material: Stahl / Glas

- Lichtquellen an der Leuchte getrennt schaltbar

Spot	200lm 3000K	

E27 <40W
Ø: 6,5 cm L: 12 cm

LED E27 | 9W | 220°
2700K | 800lm | EEK=F
9kWh/1000h

Art. Nr. 1005301

E27 <40W

LED E27 | 13,2W | 220°
2700K | 1300lm | EEK=F
13kWh/1000h

Art. Nr. 1005302

Variante	Art. Nr.
1xE27 200lm 3000K CRI80 ■ chrom / milchig	1002855

Variante	Art. Nr.
1xE27 ■ chrom / milchig	1002856



155670 221

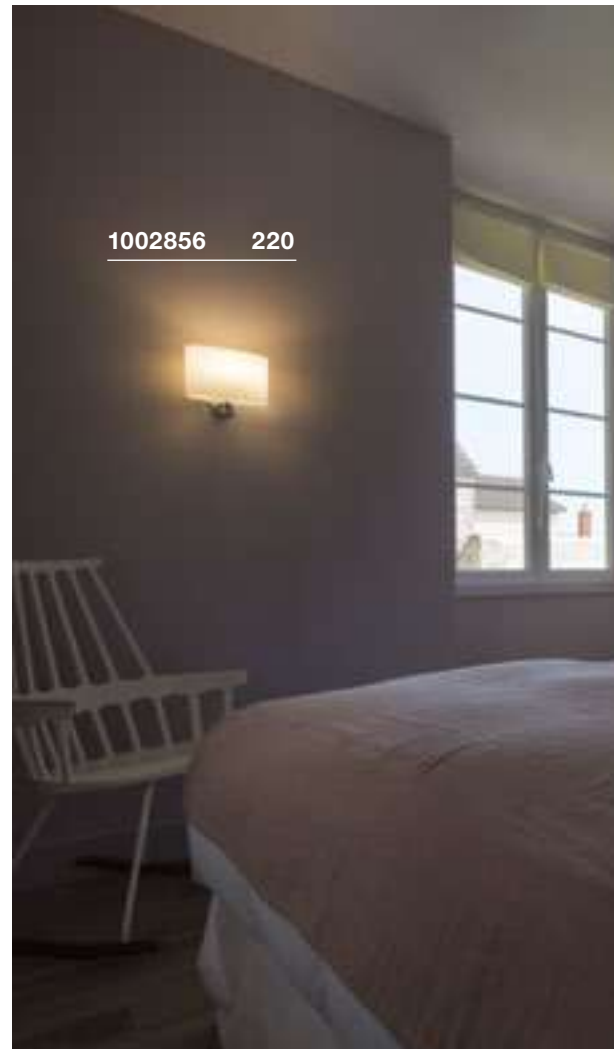

1002856 220



155670 221

ACCANTO
WL, E27



SOCKET INSIDE <40 W

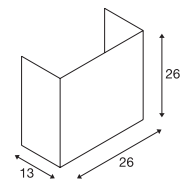

IP 20

220-240V ~50/60Hz
Material: Stahl / Textil

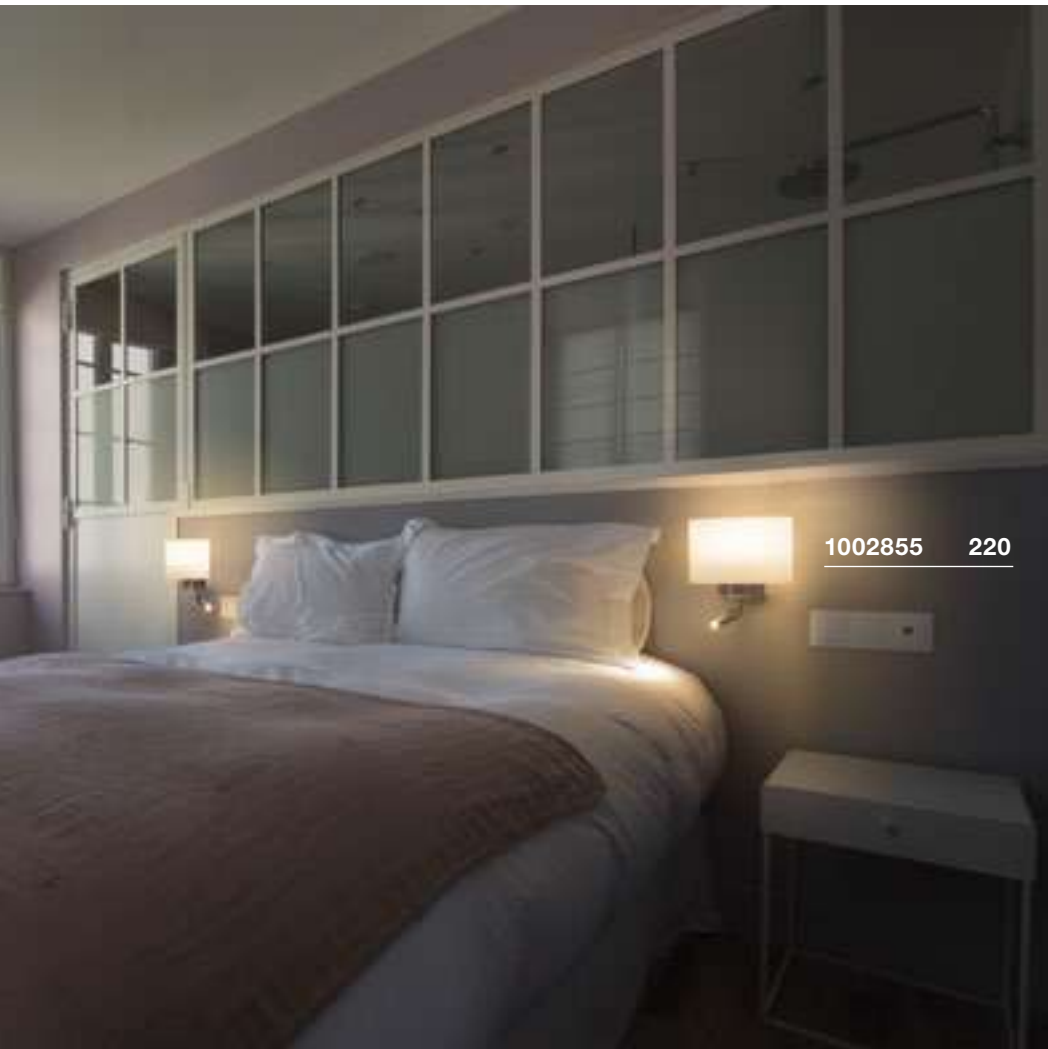

1002855 220



E27 <40W
Ø: 8 cm L: 14 cm



LED E27 | 7,5W | 320°
2700K | 700lm | EEK=F
8kWh/1000h



Art. Nr. 1005304

Variante	Art. Nr.
1xE27	
■ schwarz	1002942 ▼
1xE27	
□ weiß	1002943 ▼

COUPA FLEX
WL

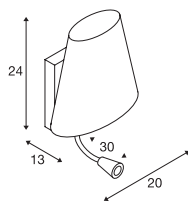
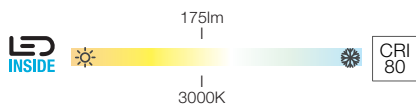
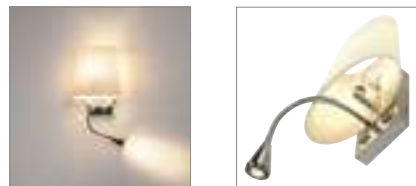

IP 20 L70B50

220-240V ~50/60Hz | 700mA
Systemleistung: 3,4W
Material: Stahl / Glas

- Lichtquellen an der Leuchte getrennt schaltbar.

Spot	175lm 3000K	A → G
		A → G

G9 <42W L: 9 cm

LED G9 | 3,6W | 300°
3000K | 400lm | EEK=E
4kWh/1000h

Art. Nr. 1005286

Variante	Art. Nr.
1xG9 175 lm 3000K CRI80 chrom / milchig	149452

COUPA
WL, QT14

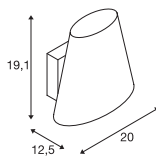
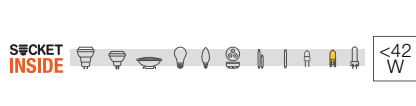

IP 20

220-240V ~50/60Hz
Material: Stahl / Glas

G9 <42W L: 9 cm

LED G9 | 3,6W | 300°
3000K | 400lm | EEK=E
4kWh/1000h

Art. Nr. 1005286

Variante	Art. Nr.
1xG9 chrom / milchig	1002859



149452 222



1002859 222



PLASTRA

WL, eckig

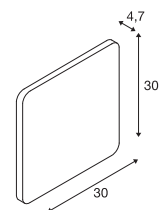
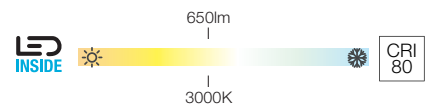
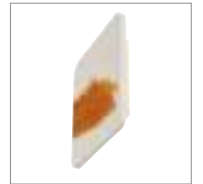

IP 20 L70B50

100-240V ~50/60Hz | 12V

Systemleistung: 10,5W

Material: Gips / Stahl



		A → G
148019	650lm 3000K	A T G → F

Variante Art. Nr.

650lm | 3000K | CRI80

□ weiß

148019

KARPO MAGN
CW, single, PHASE



350|430lm

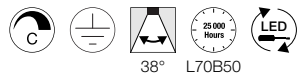
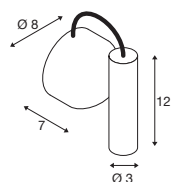

220-240V ~50/60Hz | 500mA
Systemleistung: 6,2W
Material: Stahl / Aluminium

KARPO GOOSE
WL



NEW



380|420lm

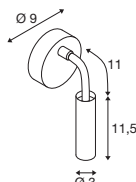
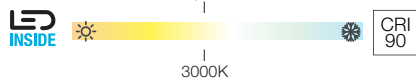

220-240V ~50/60Hz | 12V
Systemleistung: 5,8W
Material: Aluminium / Stahl

- Leuchte ist über Schalter am Leuchtenkopf dimmbar



1004706, 1004707	350lm 430lm 3000K	

Variante	Art. Nr.
350lm 3000K CRI90	
■ schwarz	1004706
430lm 3000K CRI90	
□ weiß	1004707



1006162, 1006161	380lm 420lm 3000K	

Variante	Art. Nr.
380lm 3000K CRI90	
■ schwarz	1006162 ■
420lm 3000K CRI90	
□ weiß	1006161 ■

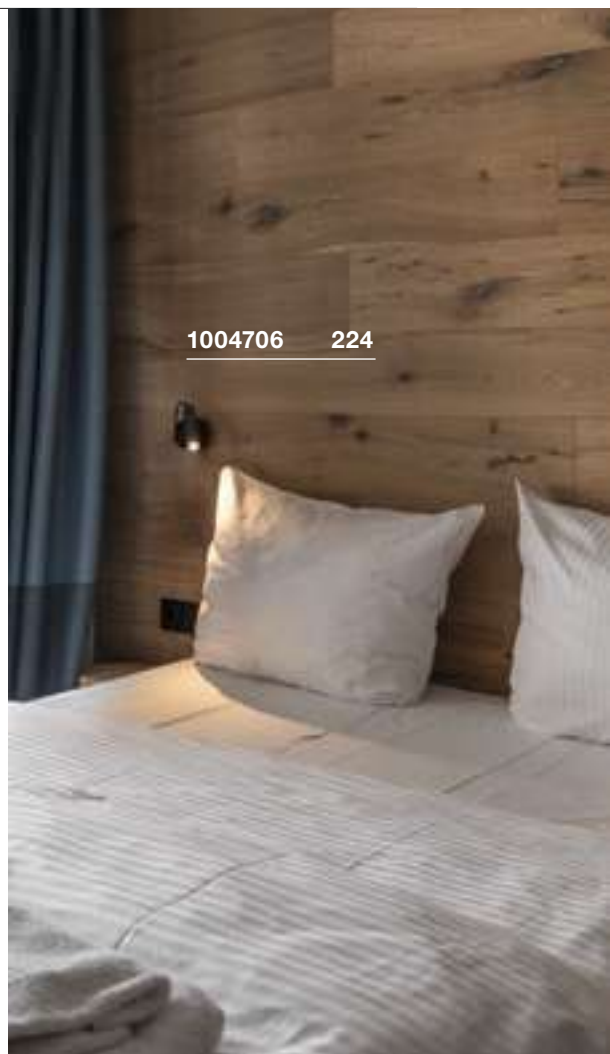

1004706 224

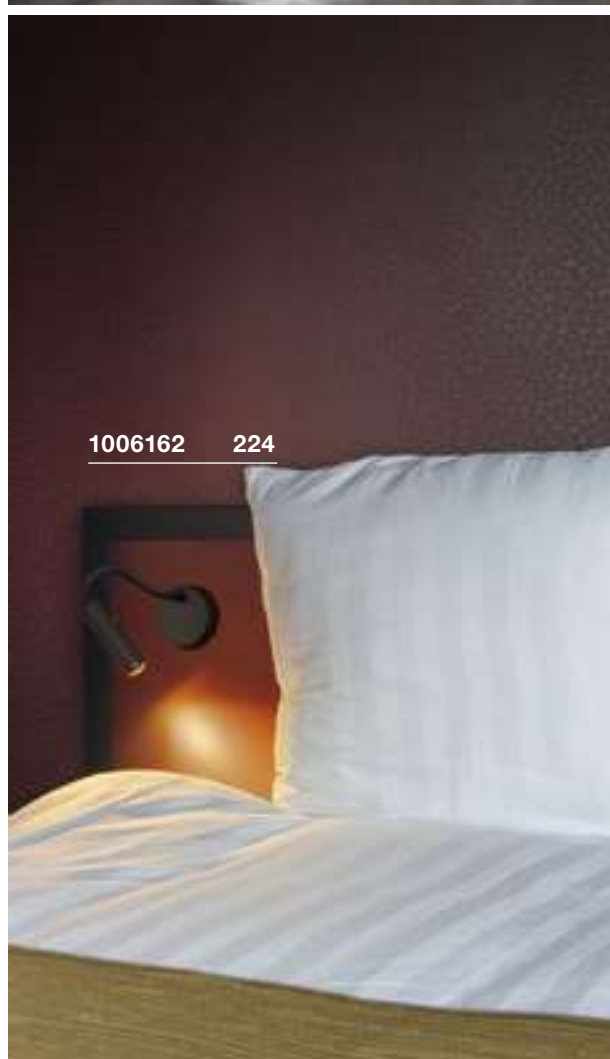

1006162 224



152340 225

KARPO 30
WL, single

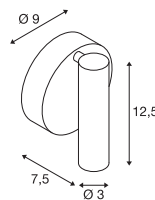
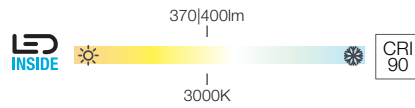

100-240V ~50/60Hz | 500mA
Systemleistung: 6W
Material: Aluminium / Stahl



1002140 225

KARPO
WL

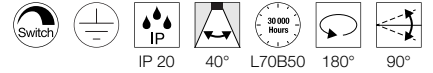
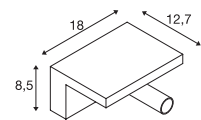
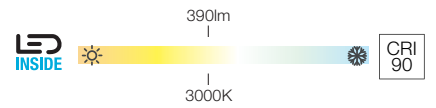

220-240V ~50/60Hz | 500mA
Systemleistung: 6,6W
Material: Aluminium

- 2 USB Anschlüsse 1,5 Amp max
- 3 Stufen dimmbar über Schalter an der Basis



152340, 152341	370lm 400lm 3000K	

Variante	Art. Nr.
370lm 3000K CRI90	
■ schwarz	152340
400lm 3000K CRI90	
□ weiß	152341



1002140	390lm 3000K	

Variante	Art. Nr.
390lm 3000K CRI90	
□ weiß	1002140

SOMNILA SPOT
WL, links

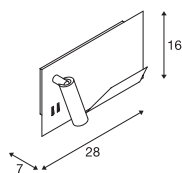
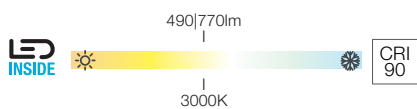

110° 340° L70B50 350° 90°

100-240V ~50/60Hz | 12V
Systemleistung: 15W
Material: Aluminium / Stahl

- 1 USB Anschluß
- Lichtquellen am Gehäuse getrennt schaltbar

SOMNILA SPOT
WL, rechts

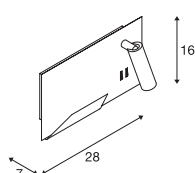
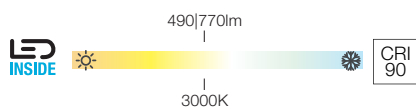

110° 340° L70B50 350° 90°

100-240V ~50/60Hz | 12V
Systemleistung: 15W
Material: Aluminium / Stahl

- 1 USB Anschluß
- Lichtquellen am Gehäuse getrennt schaltbar

Spot	120lm 3000K	
Indirect	370lm 650lm 3000K	

Variante	Art. Nr.
Spot: 120lm 3000K CRI90 Indirect: 370lm 3000K CRI90	
■ schwarz	1003455
Spot: 120lm 3000K CRI90 Indirect: 650lm 3000K CRI90	
□ weiß	1003457

Spot	120lm 3000K	
Indirect	370lm 650lm 3000K	

Variante	Art. Nr.
Spot: 120lm 3000K CRI90 Indirect: 370lm 3000K CRI90	
■ schwarz	1003456
Spot: 120lm 3000K CRI90 Indirect: 650lm 3000K CRI90	
□ weiß	1003458

1003455 226



1003457 226

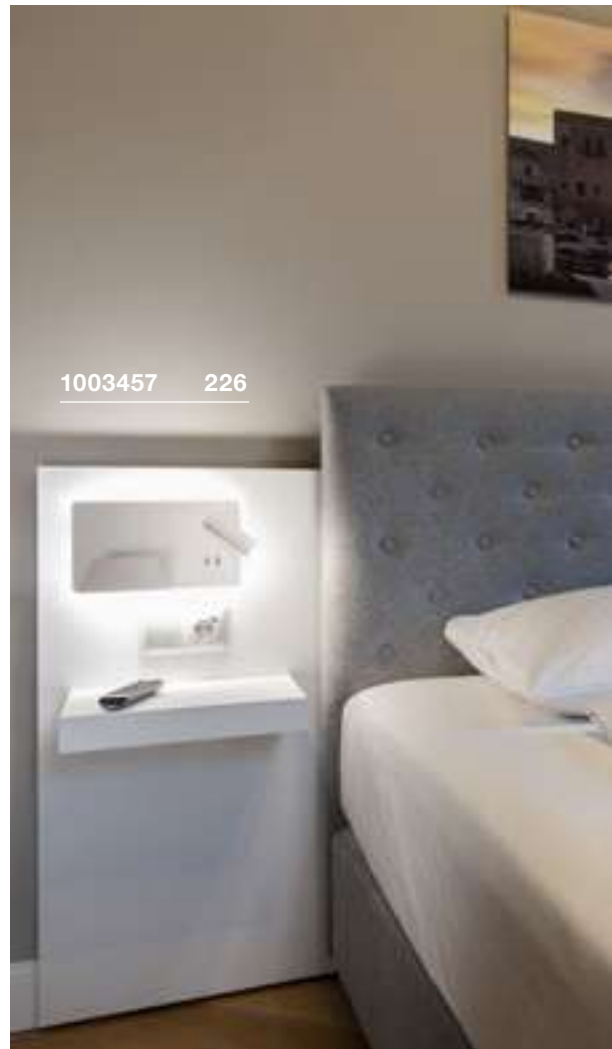



1003459 227

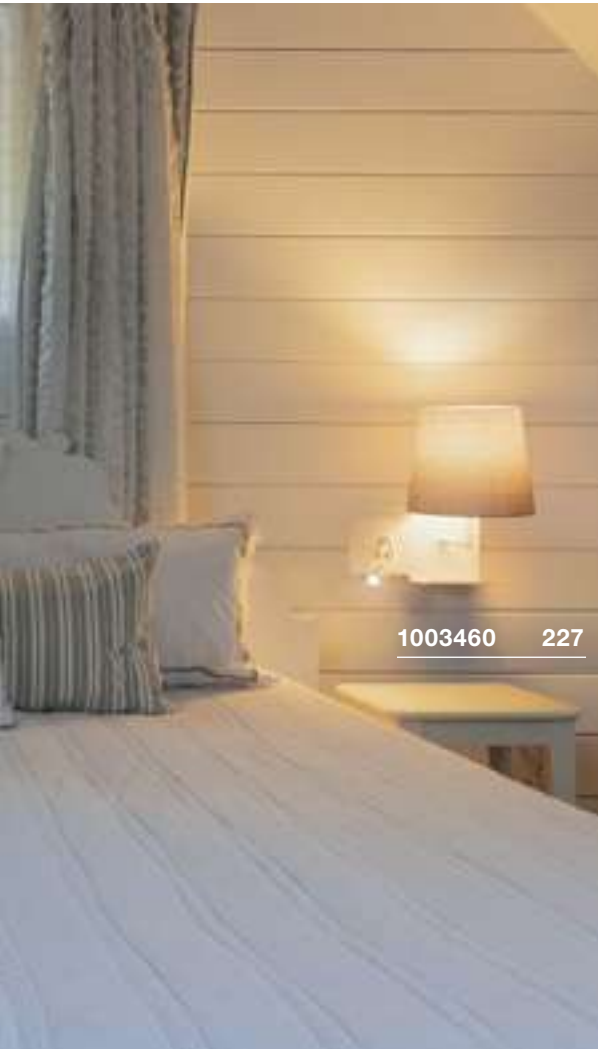

1003460 227

SOMNILA FLEX
WL, links



120lm | 3000K | CRI 90 | 40 W

LED INSIDE

SOCKET INSIDE

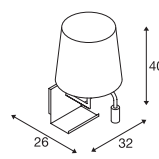

110° L70B50

30.000 Hours

LED

100-240V ~50/60Hz | 12V
Material: Aluminium / Textil

- 1 USB Anschluß
- Lichtquellen am Gehäuse getrennt schaltbar

Spot	120lm 3000K	

E27 40W L: 18 cm

LED E27 | 9W | 220°
2700K | 800lm | EEK=F
9kWh/1000h

Art. Nr. 1005301

Variante	Art. Nr.
1xE27 120lm 3000K CRI90 □ weiß	1003459

SOMNILA FLEX
WL, rechts



120lm | 3000K | CRI 90 | 40 W

LED INSIDE

SOCKET INSIDE

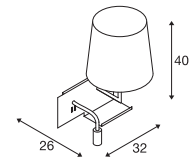

110° L70B50

35.000 Hours

LED

100-240V ~50/60Hz | 12V
Material: Aluminium / Textil

- 1 USB Anschluß
- Lichtquellen am Gehäuse getrennt schaltbar

Spot	120lm 3000K	

E27 40W L: 18 cm

LED E27 | 13,2W | 220°
2700K | 1300lm | EEK=F
13kWh/1000h

Art. Nr. 1005302

Variante	Art. Nr.
1xE27 120lm 3000K CRI90 □ weiß	1003460

DIO FLEX PLATE
WL QPAR51



SOCKET INSIDE <50 W

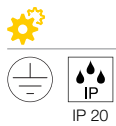
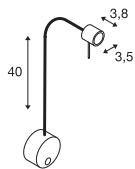

230V ~50Hz
Material: Aluminium

DIO FLEX PLATE
WL



LED INSIDE 100lm 100lm 100lm
2700K 3000K 4000K CRI 80

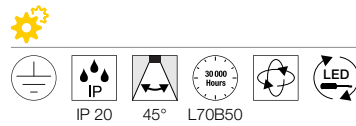
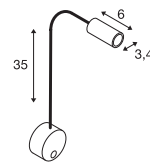

100-240V ~50/60Hz | 350mA
Systemleistung: 1,9W
Material: Aluminium

DIO FLEX PLATE
WL



LED INSIDE 100lm 100lm 100lm
2700K 3000K 4000K CRI 80

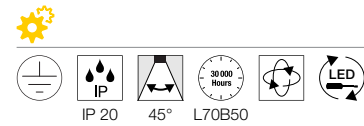
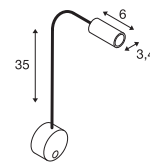

100-240V ~50/60Hz | 350mA
Systemleistung: 1,9W
Material: Aluminium

GU10 <50W

LED GU10 51mm | 4W | 36°
2700K | 270lm | EEK=G
4kWh/1000h

Art. Nr. 1004972

Leuchtmittel Dekoring Ø 5,7 cm
Art. Nr. 151040

		A → G
1002117, 1002118, 1002119	100lm 2700K 3000K 4000K	A G F

		A → G
1002430, 1002431, 1002432	100lm 2700K 3000K 4000K	A G F

Variante	Art. Nr.
1xGU10	
■ schwarz	1002608
1xGU10	
□ weiß	1002607
1xGU10	
■ chrom	146692

Variante	Art. Nr.
100lm 2700K CRI80	
□ weiß	1002117
100lm 3000K CRI80	
□ weiß	1002118
100lm 4000K CRI80	
□ weiß	1002119

Variante	Art. Nr.
100lm 2700K CRI80	
■ schwarz	1002430
100lm 3000K CRI80	
■ schwarz	1002431
100lm 4000K CRI80	
■ schwarz	1002432

DIO FLEX PLATE
WL

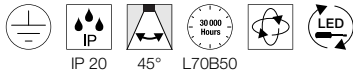
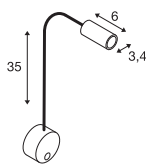
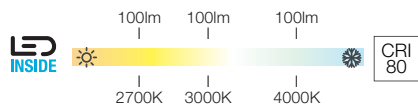

100-240V ~50/60Hz | 350mA
Systemleistung: 1,9W
Material: Aluminium



		A → G
146682, 1002116	100lm 3000K 2700K	A T G F

Variante	Art. Nr.
100lm 3000K CRI80 chrom	146682
100lm 2700K CRI80 chrom	1002116



1002117 228



1002116 229

PHELIA
WL, QPAR51



148540 230

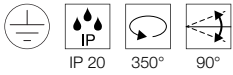
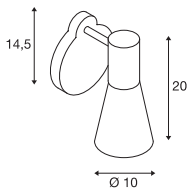

230V ~50/60Hz
Material: Aluminium / Stahl



GU10 <50W



LED GU10 51mm | 4W | 36°
2700K | 270lm | EEC=G
4kWh/1000h



Art. Nr. 1004972

Variante	Art. Nr.
1xGU10 ■ schwarz	148540





1001468 231

MERADO FLOOD
WL, PHASE

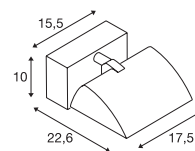
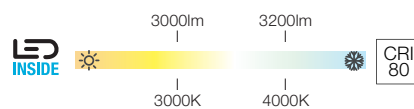
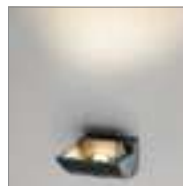
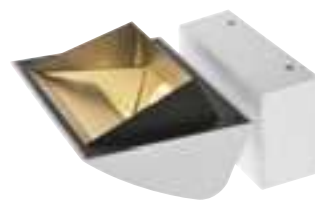

220-240V ~50/60Hz | 1000mA
Systemleistung: 40W
Material: Aluminium



1001468, 1001472	3000lm 3200lm 3000K 4000K	

Variante	Art. Nr.
3000lm 3000K CRI80 <input type="checkbox"/> weiß	1001468
3200lm 4000K CRI80 <input type="checkbox"/> weiß	1001472

MAGANDA
WL

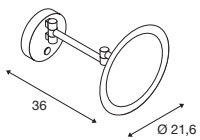
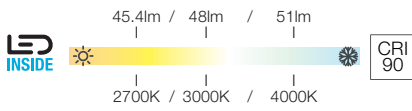
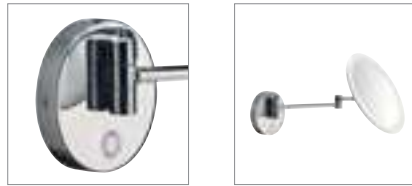

100-240V ~50/60Hz | 12V
Systemleistung: 4,8W
Material: Stahl / Glas

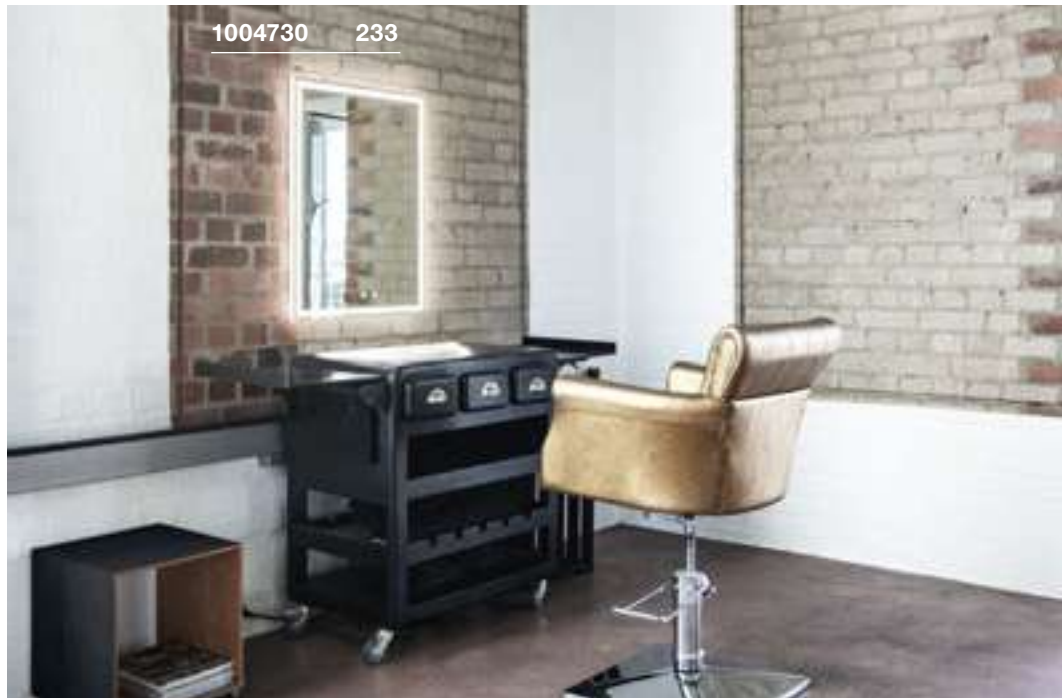

		A → G
1004971	45,4/48/51lm 2700/3000/4000K	A → G F

Variante	Art. Nr.
45,4/48/51lm 2700/3000/4000K CRI90 ■ chrom / weiß	1004971

TRUKKO
WL, rechteckig

NEW VARIANT

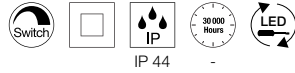
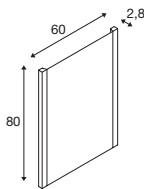
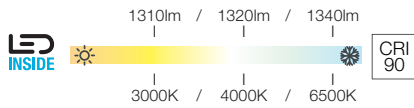

220-240V ~50/60Hz | 24V
Systemleistung: 24W
Material: Glas / Aluminium

- inkl. Spiegelheizung

TRUKKO
WL, rechteckig

CCT

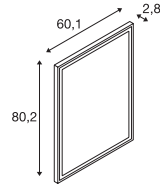
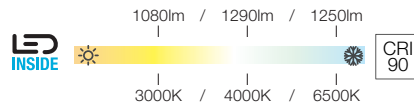
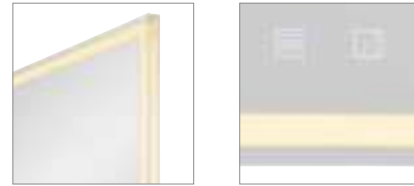

220-240V ~50/60Hz | 24V
Systemleistung: 25W
Material: Glas / Kunststoff

- inkl. Spiegelheizung

TRUKKO
WL, rund

CCT

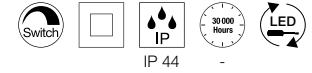
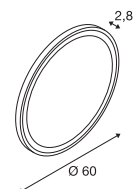
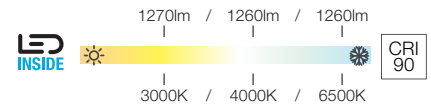

220-240V ~50/60Hz | 24V
Systemleistung: 25W
Material: Glas / Kunststoff

- inkl. Spiegelheizung



1004729	1310/1320/ 1340lm 3000/4000/ 6500K	A → G F
---------	---	------------

Variante	Art. Nr.
1310/1320/1340lm 3000/4000/6500K CRI90 silber / milchig	1004729



1004730	1080/1290/ 1250lm 3000/4000/ 6500K	A → G E
---------	---	------------

Variante	Art. Nr.
1080/1290/1250lm 3000/4000/6500K CRI90 silber / milchig	1004730



1004731	1270/1260/ 1260lm 3000/4000/ 6500K	A → G E
---------	---	------------

Variante	Art. Nr.
1270/1260/1260lm 3000/4000/6500K CRI90 silber / milchig	1004731

TRUKKO 60
WL

TRUKKO 90
WL

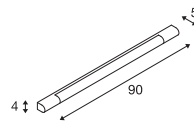
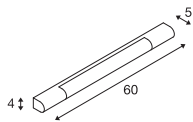
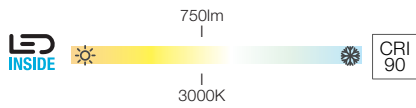
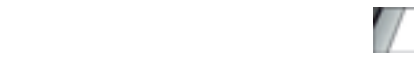

IP 44 IK03 L70B50

IP 44 IK03 L70B50

220-240V ~50/60Hz | 500mA
Systemleistung: 9,2W
Material: Aluminium / Kunststoff

220-240V ~50/60Hz | 500mA
Systemleistung: 12W
Material: Aluminium / Kunststoff

149762	750lm 3000K	

149772	1040lm 3000K	

Variante	Art. Nr.
750lm 3000K CRI90 ■ chrom / milchig	149762

Variante	Art. Nr.
1040lm 3000K CRI90 ■ chrom / milchig	149772

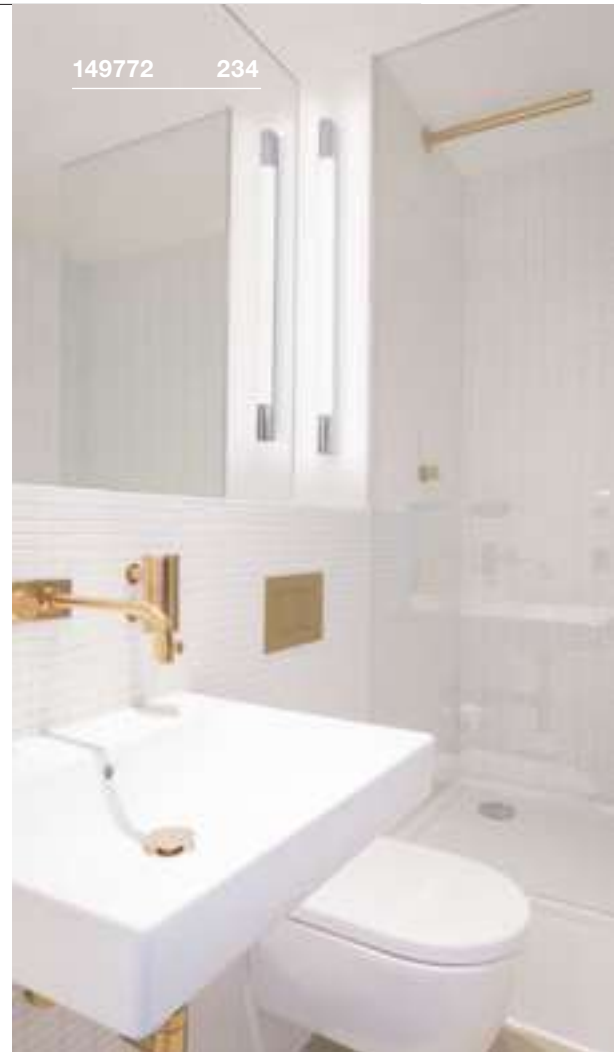



1002192 235

MARYLIN 40/60/90
WL



890|1170|1800lm / 980|1280|1990lm

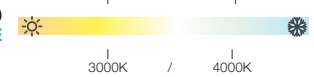

CRI 80

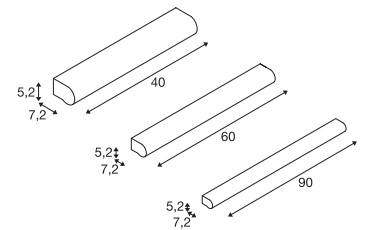

IP 44

120°

L70B50

220-240V ~50/60Hz | 350mA

Systemleistung: 11W

Material: Aluminium / Polycarbonat (PC)



		A → G
1002190, 1002191, 1002192	890/980lm 1170/1280lm 1800/1990lm 3000/4000K	

Variante	Art. Nr.
890/980lm 3000/4000K CRI80 L: 40 cm chrom / milchig	1002190
1170/1280lm 3000/4000K CRI80 L: 60 cm chrom / milchig	1002191
1800/1990lm 3000/4000K CRI80 L: 90 cm chrom / milchig	1002192



WL 106
E14



SOCKET INSIDE <40 W

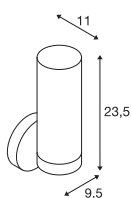

IP 44

220-240V ~50/60Hz
Material: Aluminium / Glas

E14 <40W
Ø: 3,6 cm L: 11 cm

LED E14 | 4,2W | 320°
2700K | 370lm | EEK=F
4kWh/1000h

Art. Nr. 1005284

Variante	Art. Nr.
1xE14 ■ chrom	1002228

WL 106
E14



SOCKET INSIDE <40 W

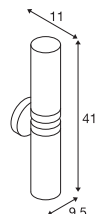

IP 44

220-240V ~50/60Hz
Material: Aluminium / Glas

E14 <40W
Ø: 3,6 cm L: 11 cm

LED E14 | 4,2W | 320°
2700K | 370lm | EEK=F
4kWh/1000h

Art. Nr. 1005284

Variante	Art. Nr.
2xE14 ■ chrom	1002229

MIBO UP/DOWN
WL, QT14



SOCKET INSIDE <25 W

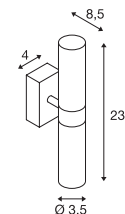

IP 21

220-240V ~50/60Hz
Material: Aluminium / Glas

G9 <25W

LED G9 | 3,6W | 300°
3000K | 400lm | EEK=E
4kWh/1000h

Art. Nr. 1005286

Variante	Art. Nr.
2xG9 ■ chrom	151282

DORISA 30

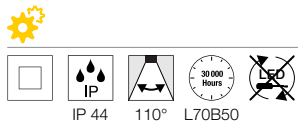
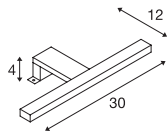
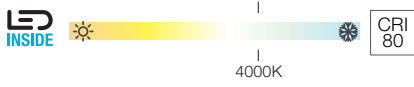

200-240V ~50Hz | 340mA
 Systemleistung: 5,2W
 Material: Aluminium / Kunststoff

- Klemmbereich: 0-6 mm. Durch demontage der Halterung zur Spiegelleuchte umfunktionierbar

1000777	300lm 4000K	

Variante	Art. Nr.
300lm 4000K CRI80 chrom	1000777



1000780 239



DORISA 50



370lm

4000K



CRI 80

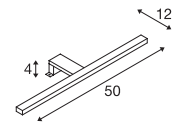

IP 44



110°



30 000 Hours







L70B50

200-240V ~50Hz | 340mA
 Systemleistung: 6,6W
 Material: Aluminium / Kunststoff

- Klemmbereich: 0-6 mm. Durch demontage der Halterung zur Spiegelleuchte umfunktionierbar



		
1000780	370lm 4000K	

Variante	Art. Nr.
370lm 4000K CRI80 chrom	1000780

SPIEGELLEUCHTEN HIGHLIGHTS. UNSER PERFEKTES LICHT IM BAD.



1000669 243



GLENOS® 60 | 241



L-LINE 60 | 242



L-LINE 120 | 242



Q-LINE® | 243

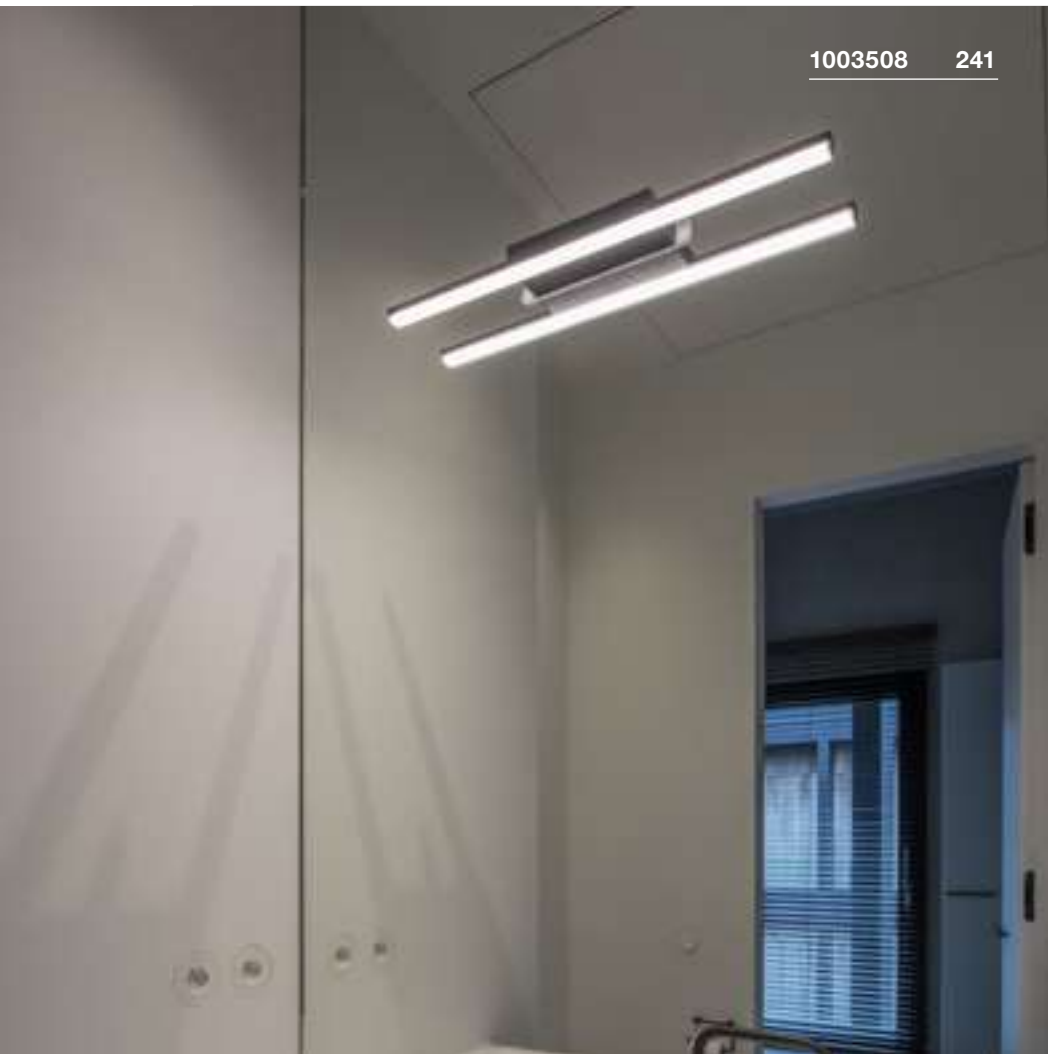

1003508 241

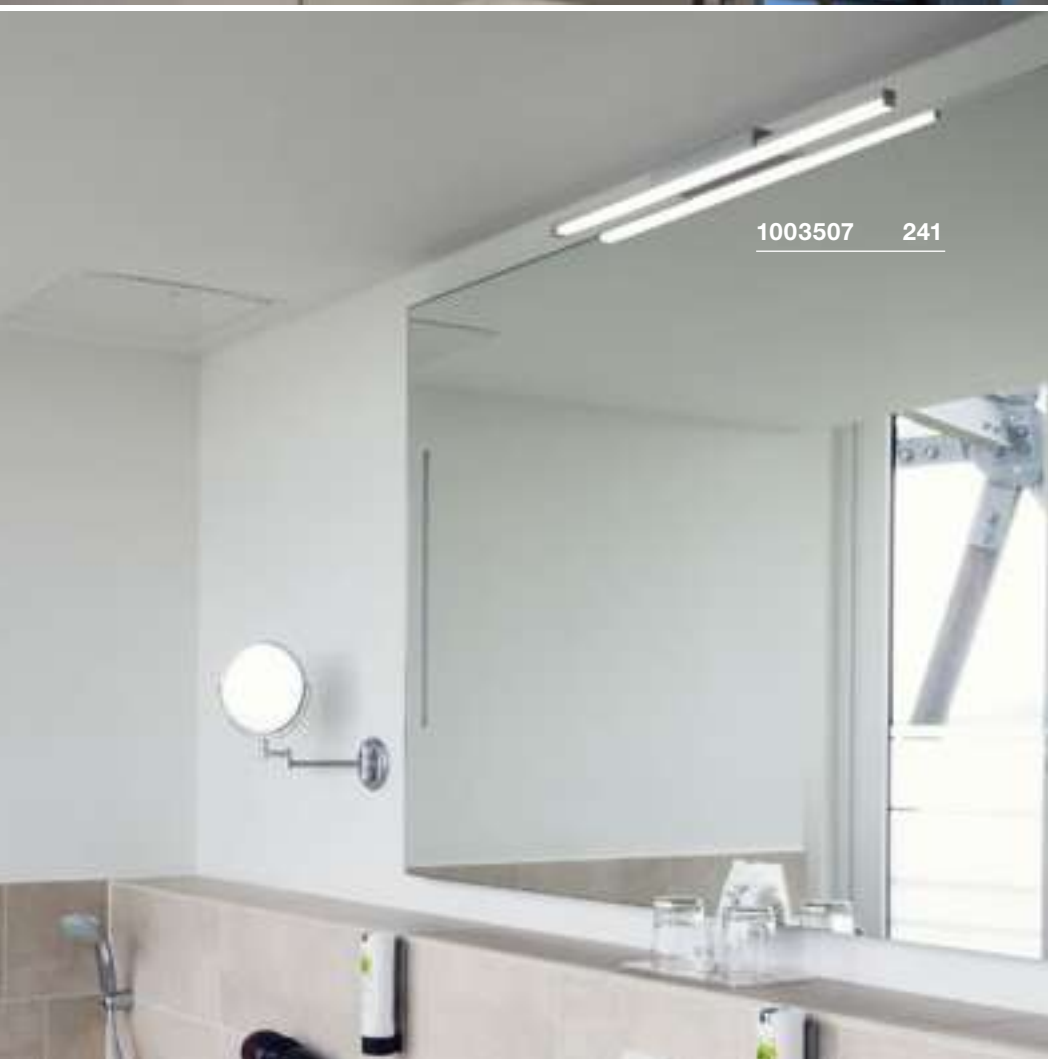

1003507 241

GLENOS® 60
WL

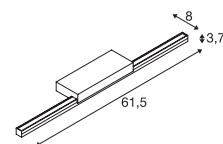
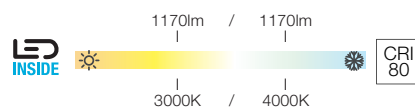

220-240V ~50/60Hz | 500mA
Systemleistung: 12W
Material: Aluminium / Polycarbonat (PC)



1003506, 1003507, 1003508	1170lm 3000/4000K	

Variante	Art. Nr.
1170lm 3000/4000K CRI80	
■ schwarz	1003506
1170lm 3000/4000K CRI80	
□ weiß	1003507
1170lm 3000/4000K CRI80	
■ grau	1003508

L-LINE 60
WL

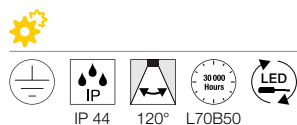
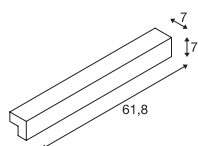
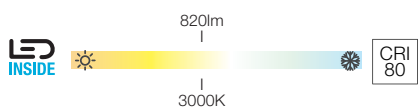

220-240V ~50/60Hz | 350mA
Systemleistung: 10W
Material: Aluminium / Polycarbonat (PC)

L-LINE 120
WL

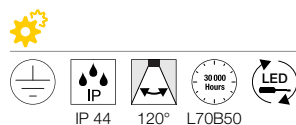
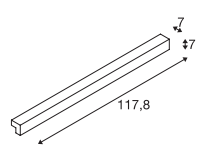
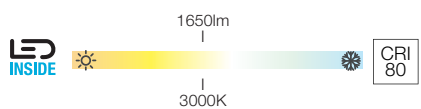

220-240V ~50/60Hz | 350mA
Systemleistung: 18,5W
Material: Aluminium / Polycarbonat (PC)

1001299, 1001300, 1001301	820lm 3000K	

1001303, 1001304, 1001305	1650lm 3000K	

Variante	Art. Nr.
820lm 3000K CRI80 □ weiß	1001299
820lm 3000K CRI80 ■ silber	1001300
820lm 3000K CRI80 ■ grau	1001301

Variante	Art. Nr.
1650lm 3000K CRI80 □ weiß	1001303
1650lm 3000K CRI80 ■ silber	1001304
1650lm 3000K CRI80 ■ grau	1001305

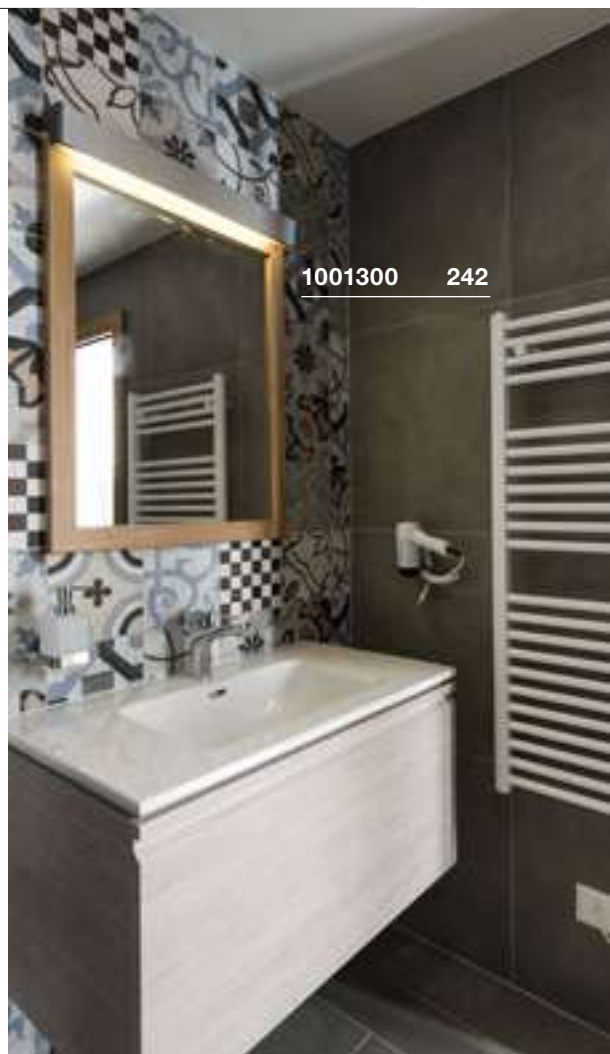

1001300 242



1001305 242



1000668 243

Q-LINE®
WL

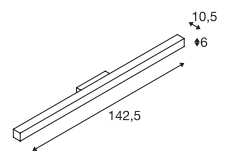
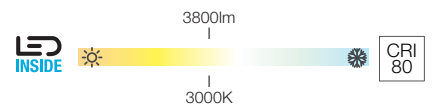
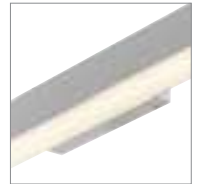

IP 20 110° L70B50

220-240V ~50/60Hz | 700mA
Systemleistung: 45W
Material: Aluminium / Acryl



		A → G
1000669, 1000668, 1000670	3800lm 3000K	

Variante	Art. Nr.
3800lm 3000K CRI80 ■ schwarz	1000669
3800lm 3000K CRI80 □ weiß	1000668
3800lm 3000K CRI80 ■ grau	1000670

RETRATO
WL, PHASE

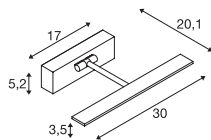
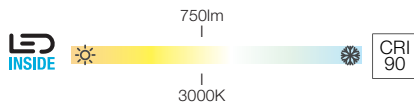

220-240V ~50/60Hz | 500mA
Systemleistung: 11W
Material: Aluminium / Stahl

1002961 244

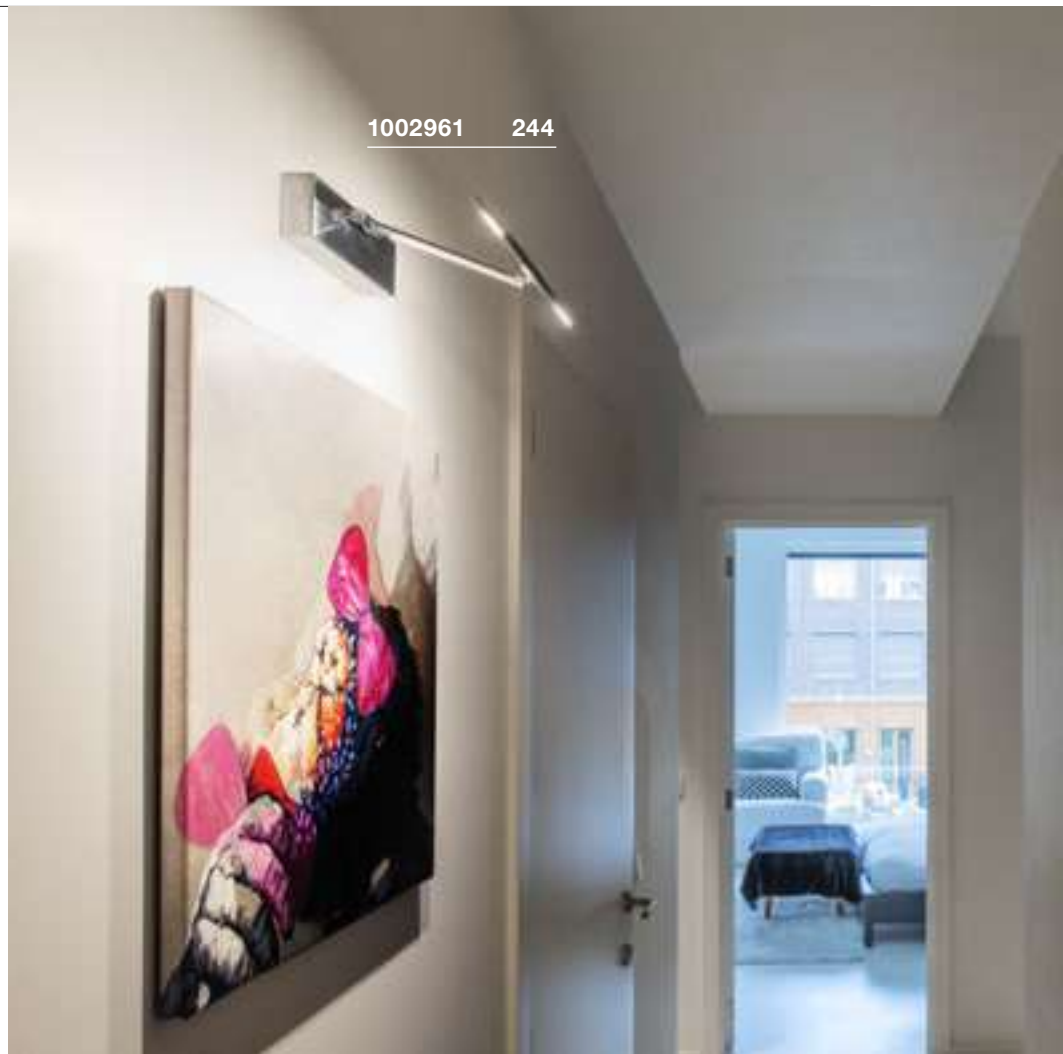

		A → G
1002960, 1002961	750lm 3000K	A → G

Variante	Art. Nr.
750lm 3000K CRI90 weiß / chrom	1002960
750lm 3000K CRI90 chrom	1002961

1002860 245



DISPLAY ADL 50
QPAR51

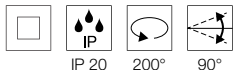
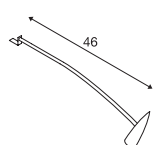
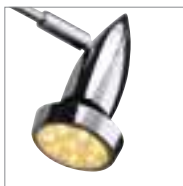
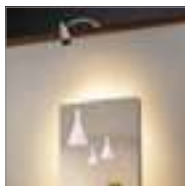

220-240V ~50/60Hz
Material: Aluminium / Messing



GU10 <50W



LED GU10 51mm | 4W | 36°
3000K | 280lm | EEK=F
4kWh/1000h



Art. Nr. 1004973



Leuchtmittel Dekoring Ø 5,7 cm

Art. Nr. 151041



Leuchtmittel Dekoring Ø 5,7 cm

Art. Nr. 151049



Variante	Art. Nr.
1xGU10	
<input type="checkbox"/> weiß	1002860
1xGU10	
<input type="checkbox"/> chrom	146332

SPOT DISPLAY
E27

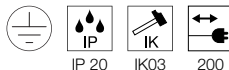
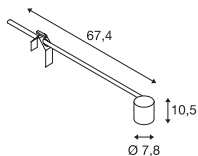
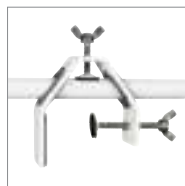

220-240V ~50/60Hz
Material: Aluminium / Stahl

- Schutzkontaktstecker
- Klemmbereich 10 - 60 mm



E27 <18,5W



LED E27 | 7,5W | 320°
2700K | 800lm | EEK=E
8kWh/1000h



Art. Nr. 1005309

NEPRO DISPLAY
QT-DE12

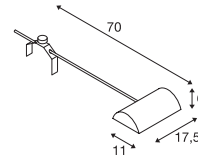

230V ~50Hz
Material: Aluminium

- Schutzkontaktstecker und Schalter
- Klemmbereich: 15-55 mm
- Schutzkontaktstecker und Schalter



R7s 118mm <300W



LED R7s | 15W | 330°
3000K | 2000lm | EEK=E
15kWh/1000h



Art. Nr. 1005288

Variante	Art. Nr.
1xR7s 118mm	
<input type="checkbox"/> grau	146472 ▼

ALLES GUTE KOMMT VON OBEN.

DECKENLEUCHTEN
FÜR FLEXIBLE BELEUCHTUNG.

Deckenleuchten sind das Herzstück jeder Raumbelichtung. Mit ihrer Strahlkraft bringen sie eine warme Atmosphäre in jeden Raum. Angepasst an das Raumkonzept können Sie die Leuchten individuell ausrichten und so auch von ganz oben beeindruckende Lichtakzente setzen.



































































1001886 258



Deckenleuchten aus dem NUMINOS® Down- und Spotlightsystem finden Sie auf den Seiten 72 bis 86. Oder ganz einfach online konfigurieren unter: www.numinos.slv.com

1004519 83

DECKENLEUCHTEN

 250	 251	 254	 255	 255	 255	 257	 258
 258	 258	 259	 260	 260	 260	 261	 261
 262	 262	 263	 263	 264	 264	 265	 265
 266	 266	 266	 269	 269	 269	 270	 270
 271	 273	 273	 274	 274	 275	 275	 276
 277	 277	 277	 278	 278	 279	 280	 281
 281	 281	 282	 282	 282	 283	 284	 285
 287	 287	 287	 288	 288	 289	 289	 289

NEW VARIANT

NEW VARIANT

MEDO LEUCHTENFAMILIE.

DECKEN- ODER PENDELLEUCHE.

	MEDO 30 CL, 1-10V	MEDO 40 CL, 1-10V	MEDO 60 CL, 1-10V	MEDO 90 CL, 1-10V
Beispiel				
Leuchtmittel				
Größe	Ø: 30 cm	Ø: 40 cm	Ø: 60 cm	Ø: 90 cm
Lichtstärke	1000lm	2000lm	3500lm	11000lm
UGR	25	25	22	25
Dimmbar	1-10V	1-10V	1-10V	1-10V
Abhängeset	1,5 m 5 m	1,5 m 5 m	1,5 m 5 m	1,5 m 5 m

	MEDO 30 CL, PHASE	MEDO 40 CL, PHASE	
Beispiel			
Leuchtmittel			
Größe-Ø	Ø: 30 cm	Ø: 40 cm	
Lichtstärke	1200lm	2125lm	
UGR	25	25	
Dimmbar	C, L	C, L	
Abhängeset (exkl.)	1,5 m 5 m	1,5 m 5 m	



	MEDO 60 CL, quadratisch, 1-10V	MEDO 60 CL, quadratisch, DALI
Beispiel		
Leuchtmittel		
Größe	B L: 60 cm	B L: 60 cm
Lichtstärke	3300 lm	3300 lm
UGR	22	22
Dimmbar	1-10V	
Abhängeset	1,5 m 5 m	1,5 m 5 m



MEDO LEUCHTENFAMILIE.

DECKEN- ODER PENDELLEUCHE.

	MEDO 30 AMBIENT CW, PHASE	MEDO 40 AMBIENT CW, PHASE	MEDO 60 AMBIENT CW, PHASE	MEDO 90 AMBIENT CL, PHASE
Beispiel				
Leuchtmittel				
Größe	Ø: 30 cm	Ø: 40 cm	Ø: 60 cm	Ø: 90 cm
Lichtstärke	Down: 1230/1280lm Up: 20lm	Down: 2750/2900lm Up: 50lm	Down: 4350/4750lm Up: 120lm	Down: 9500/10100lm Up: 125lm
UGR	25	25	25	25
Dimmbar	C	C	C	C
Abhängeset	1,5 m 5 m	1,5 m 5 m	1,5 m 5 m	1,5 m 5 m

	MEDO 30 AMBIENT CW, DALI	MEDO 40 AMBIENT CW, DALI	MEDO 60 AMBIENT CW, DALI	MEDO 90 AMBIENT CL, DALI
Beispiel				
Leuchtmittel				
Größe	Ø: 30 cm	Ø: 40 cm	Ø: 60 cm	Ø: 90 cm
Lichtstärke	Down: 1230/1280lm Up: 20lm	Down: 2750/2900lm Up: 50lm	Down: 4350/4750lm Up: 120lm	Down: 9500/10100lm Up: 125lm
UGR	25	25	25	25
Dimmbar				
Abhängeset	1,5 m 5 m	1,5 m 5 m	1,5 m 5 m	1,5 m 5 m

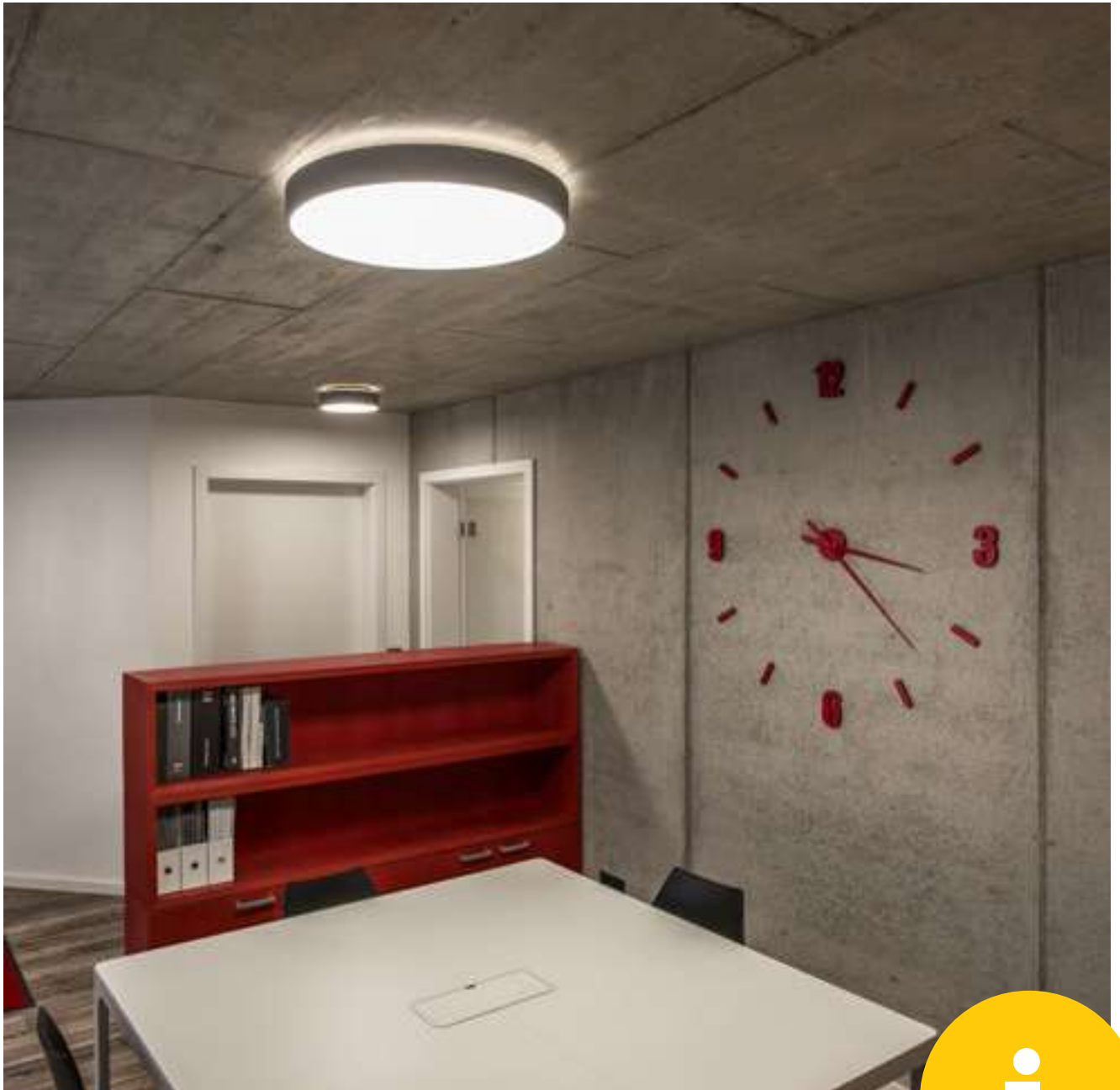

Ambient Effekt – Diese MEDO Varianten verfügen über einen homogenen indirekten Lichtaustritt nach oben.



Farbtemperatur – Bei dieser MEDO Variante können Sie die Farbtemperatur selber wählen. Durch den Schalter auf der Rückseite kann zwischen 3000K und 4000K gewählt werden.



135121 255

1000864 255

MEDO 30
CL, 1-10V

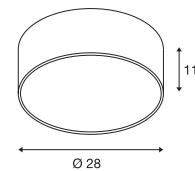
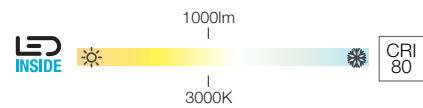

220-240V ~50/60Hz | 350mA
Systemleistung: 15W
Material: Aluminium / Polymethylacrylat (PMMA)
• Abhängeset exkl.



		A → G
1000855, 1000856, 1000857	1000lm 3000K	A G D



- Abhängeset 1,5m
Art. Nr. 135250
- Abhängeset 1,5m
Art. Nr. 135251
- Abhängeset 1,5m
Art. Nr. 135254
- 1-10V Dimming
Art. Nr. 470505
- Abhängeset 5m
Art. Nr. 1001950
- Abhängeset 5m
Art. Nr. 1001951
- Abhängeset 5m
Art. Nr. 1001952

Variante	Art. Nr.
1000lm 3000K CRI80	
<input checked="" type="checkbox"/> schwarz	1000855
1000lm 3000K CRI80	
<input type="checkbox"/> weiß	1000856
1000lm 3000K CRI80	
<input checked="" type="checkbox"/> grau	1000857

MEDO 40
CL, 1-10V

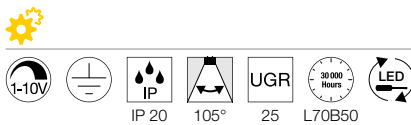
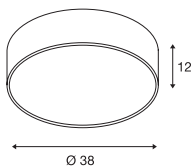
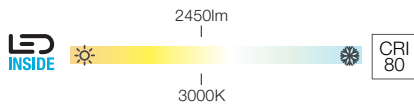

220-240V ~50/60Hz | 700mA
Systemleistung: 28W
Material: Aluminium / Polymethylacrylat (PMMA)
• Abhängeset exkl.

1000864, 1000865, 1000866	2450lm 3000K	

■ Abhängeset 1,5m Art. Nr. 135250		
□ Abhängeset 1,5m Art. Nr. 135251		
■ Abhängeset 1,5m Art. Nr. 135254		
□ 1-10V Dimming Art. Nr. 470505		
□ Abhängeset 5m Art. Nr. 1001950		
■ Abhängeset 5m Art. Nr. 1001951		
■ Abhängeset 5m Art. Nr. 1001952		

Variante	Art. Nr.
2450lm 3000K CRI80	
■ schwarz	1000864
2450lm 3000K CRI80	
□ weiß	1000865
2450lm 3000K CRI80	
■ grau	1000866

MEDO 60
CL, 1-10V

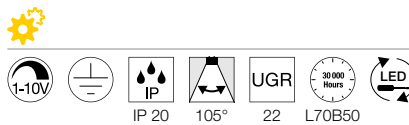
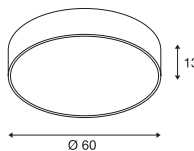
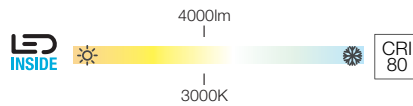

220-240V ~50/60Hz | 1000mA
Systemleistung: 38W
Material: Aluminium / Polymethylacrylat (PMMA)
• Abhängeset exkl.

135120, 135121, 135124	4000lm 3000K	

■ Abhängeset 1,5m Art. Nr. 135250		
□ Abhängeset 1,5m Art. Nr. 135251		
■ Abhängeset 1,5m Art. Nr. 135254		
□ 1-10V Dimming Art. Nr. 470505		
□ Abhängeset 5m Art. Nr. 1001950		
■ Abhängeset 5m Art. Nr. 1001951		
■ Abhängeset 5m Art. Nr. 1001952		

Variante	Art. Nr.
4000lm 3000K CRI80	
■ schwarz	135120
4000lm 3000K CRI80	
□ weiß	135121
4000lm 3000K CRI80	
■ grau	135124

MEDO 90
CL, 1-10V

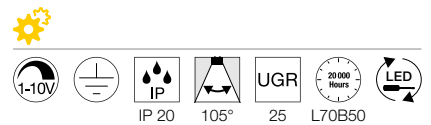
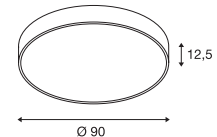
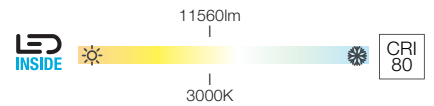

220-240V ~50/60Hz | 2900mA
Systemleistung: 109W
Material: Aluminium / Polymethylacrylat (PMMA)
• Abhängeset exkl.

135170, 135171, 135174	11560lm 3000K	

■ Abhängeset 1,5m Art. Nr. 135250		
□ Abhängeset 1,5m Art. Nr. 135251		
■ Abhängeset 1,5m Art. Nr. 135254		
□ 1-10V Dimming Art. Nr. 470505		
□ Abhängeset 5m Art. Nr. 1001950		
■ Abhängeset 5m Art. Nr. 1001951		
■ Abhängeset 5m Art. Nr. 1001952		

Variante	Art. Nr.
11560lm 3000K CRI80	
■ schwarz	135170
11560lm 3000K CRI80	
□ weiß	135171
11560lm 3000K CRI80	
■ grau	135174

MEDO 60
CL, quadratisch, 1-10V

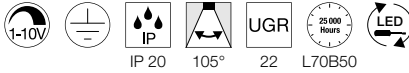
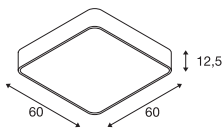
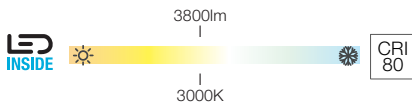

220-240V ~50/60Hz | 1000mA
Systemleistung: 39W
Material: Aluminium / Acryl
• Abhängeset exkl.



1000725, 1000726, 1000727	3800lm 3000K	



- Abhängeset 1,5m
Art. Nr. 135250
- Abhängeset 1,5m
Art. Nr. 135251
- Abhängeset 1,5m
Art. Nr. 135254
- 1-10V Dimming
Art. Nr. 470505
- Abhängeset 5m
Art. Nr. 1001950
- Abhängeset 5m
Art. Nr. 1001951
- Abhängeset 5m
Art. Nr. 1001952

Variante	Art. Nr.
3800lm 3000K CRI80	
<input checked="" type="checkbox"/> schwarz	1000725
3800lm 3000K CRI80	
<input type="checkbox"/> weiß	1000726
3800lm 3000K CRI80	
<input checked="" type="checkbox"/> grau	1000727

1000725 256

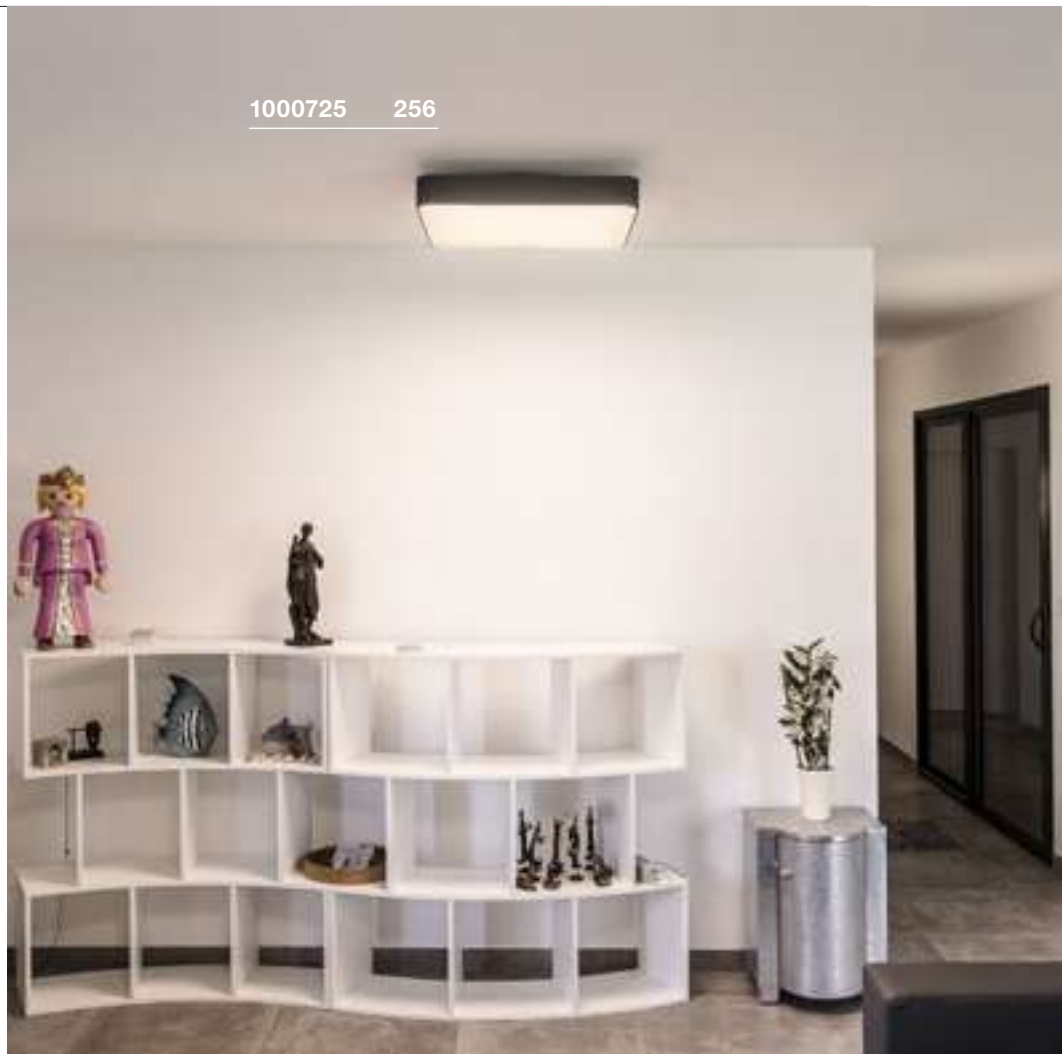

135021 257

135171 255

135121 255





135071 257

MEDO 30
CL, PHASE

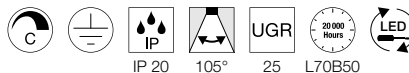
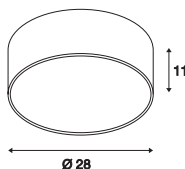
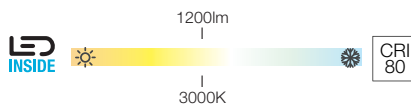

220-240V ~50/60Hz | 350mA
Systemleistung: 16W
Material: Aluminium / Polymethylacrylat (PMMA)
• Abhängeset exkl.



		A → G
135020, 135021, 135024	1200lm 3000K	A t G D



- Abhängeset 1,5m
Art. Nr. 135250
- Abhängeset 1,5m
Art. Nr. 135251
- Abhängeset 1,5m
Art. Nr. 135254
- Abhängeset 5m
Art. Nr. 1001950
- Abhängeset 5m
Art. Nr. 1001951
- Abhängeset 5m
Art. Nr. 1001952

Variante	Art. Nr.
1200lm 3000K CRI80	
■ schwarz	135020
1200lm 3000K CRI80	
□ weiß	135021
1200lm 3000K CRI80	
■ grau	135024

MEDO 40
CL, PHASE

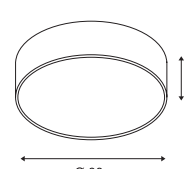
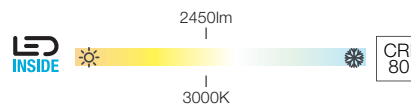

220-240V ~50/60Hz | 700mA
Systemleistung: 28W
Material: Aluminium / Polymethylacrylat (PMMA)
• Abhängeset exkl.



		A → G
135070, 135071, 135074	2450lm 3000K	A t G E



- Abhängeset 1,5m
Art. Nr. 135250
- Abhängeset 1,5m
Art. Nr. 135251
- Abhängeset 1,5m
Art. Nr. 135254
- Abhängeset 5m
Art. Nr. 1001950
- Abhängeset 5m
Art. Nr. 1001951
- Abhängeset 5m
Art. Nr. 1001952

Variante	Art. Nr.
2450lm 3000K CRI80	
■ schwarz	135070
2450lm 3000K CRI80	
□ weiß	135071
2450lm 3000K CRI80	
■ grau	135074

MEDO 30 AMBIENT
CW, PHASE

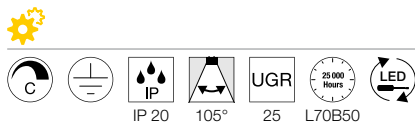
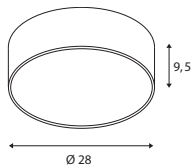
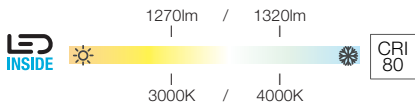

220-240V ~50/60Hz | 350mA
Systemleistung: 15W
Material: Aluminium / Polycarbonat (PC)
• Abhängeset exkl.

Up/Down	1270/1320lm 3000/4000K	

- Abhängeset 1,5m
Art. Nr. 135250
- Abhängeset 1,5m
Art. Nr. 135251
- Abhängeset 1,5m
Art. Nr. 135254
- Abhängeset 5m
Art. Nr. 1001950
- Abhängeset 5m
Art. Nr. 1001951
- Abhängeset 5m
Art. Nr. 1001952

Variante	Art. Nr.
Up: 20/20lm 3000/4000K CRI80 Down: 1250/1300lm 3000/4000K CRI80	<input checked="" type="checkbox"/> schwarz 1001877
Up: 20/20lm 3000/4000K CRI80 Down: 1250/1300lm 3000/4000K CRI80	<input type="checkbox"/> weiß 1001881
Up: 20/20lm 3000/4000K CRI80 Down: 1250/1300lm 3000/4000K CRI80	<input checked="" type="checkbox"/> grau 1001882

MEDO 40 AMBIENT
CW, PHASE

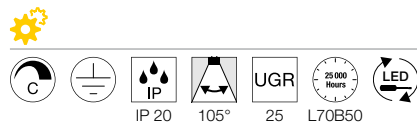
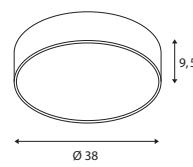
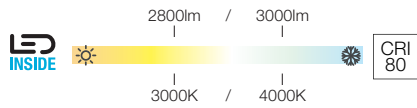
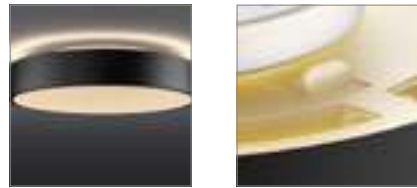

220-240V ~50/60Hz | 700mA
Systemleistung: 30W
Material: Aluminium / Polycarbonat (PC)
• Abhängeset exkl.

Up/Down	2750/3000lm 3000/4000K	

- Abhängeset 1,5m
Art. Nr. 135250
- Abhängeset 1,5m
Art. Nr. 135251
- Abhängeset 1,5m
Art. Nr. 135254
- Abhängeset 5m
Art. Nr. 1001950
- Abhängeset 5m
Art. Nr. 1001951
- Abhängeset 5m
Art. Nr. 1001952

Variante	Art. Nr.
Up: 50/50lm 3000/4000K CRI80 Down: 2750/2950lm 3000/4000K CRI80	<input checked="" type="checkbox"/> schwarz 1001883
Up: 50/50lm 3000/4000K CRI80 Down: 2750/2950lm 3000/4000K CRI80	<input type="checkbox"/> weiß 1001884
Up: 50/50lm 3000/4000K CRI80 Down: 2750/2950lm 3000/4000K CRI80	<input checked="" type="checkbox"/> grau 1001885

MEDO 60 AMBIENT
CW, PHASE

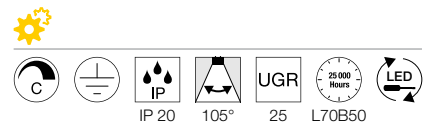
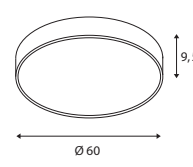
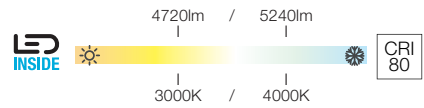
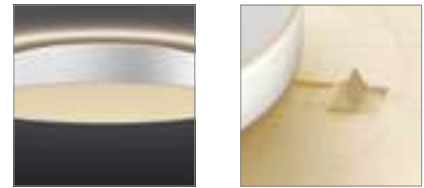

220-240V ~50/60Hz | 1050mA
Systemleistung: 40W
Material: Aluminium / Polycarbonat (PC)
• Abhängeset exkl.

Up/Down	4720/5240lm 3000/4000K	

- Abhängeset 1,5m
Art. Nr. 135250
- Abhängeset 1,5m
Art. Nr. 135251
- Abhängeset 1,5m
Art. Nr. 135254
- Abhängeset 5m
Art. Nr. 1001950
- Abhängeset 5m
Art. Nr. 1001951
- Abhängeset 5m
Art. Nr. 1001952

Variante	Art. Nr.
Up: 120/120lm 3000/4000K CRI80 Down: 4600/5120lm 3000/4000K CRI80	<input checked="" type="checkbox"/> schwarz 1001886
Up: 120/120lm 3000/4000K CRI80 Down: 4600/5120lm 3000/4000K CRI80	<input type="checkbox"/> weiß 1001887
Up: 120/120lm 3000/4000K CRI80 Down: 4600/5120lm 3000/4000K CRI80	<input checked="" type="checkbox"/> grau 1001888

MEDO 90 AMBIENT
CL, PHASE

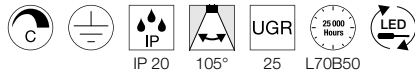
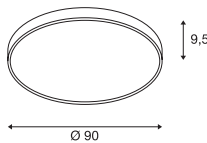
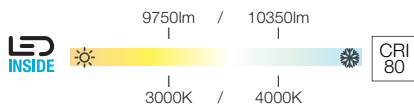
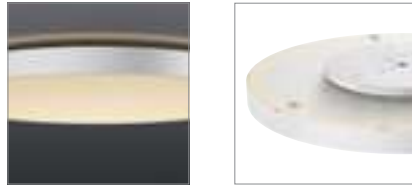

220-240V ~50/60Hz | 1050mA
Systemleistung: 78W
Material: Aluminium / Polycarbonat (PC)
• Abhängeset exkl.



		A → G
Up/Down	9750/10350lm 3000/4000K	A G D



■ Abhängeset 1,5m Art. Nr. 135250	
□ Abhängeset 1,5m Art. Nr. 135251	
■ Abhängeset 1,5m Art. Nr. 135254	
□ Abhängeset 5m Art. Nr. 1001950	
■ Abhängeset 5m Art. Nr. 1001951	
■ Abhängeset 5m Art. Nr. 1001952	

Variante	Art. Nr.
Up: 125/125lm 3000/4000K CRI80 Down: 9625/10225lm 3000/4000K CRI80	
■ schwarz	1001878
Up: 125/125lm 3000/4000K CRI80 Down: 9625/10225lm 3000/4000K CRI80	
□ weiß	1001879
Up: 125/125lm 3000/4000K CRI80 Down: 9625/10225lm 3000/4000K CRI80	
■ grau	1001880



1001887 258

1001881 258

MEDO 30 AMBIENT
CW, DALI

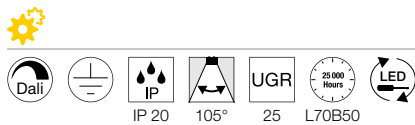
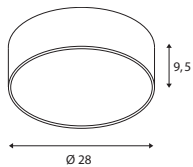
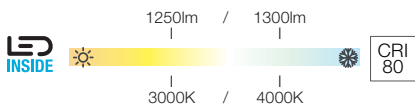

220-240V ~50/60Hz | 350mA
Systemleistung: 15W
Material: Aluminium / Polycarbonat (PC)
• Abhängeset exkl.

Up/Down	1230/1280lm 3000/4000K	

- Abhängeset 1,5m
Art. Nr. 135250
- Abhängeset 1,5m
Art. Nr. 135251
- Abhängeset 1,5m
Art. Nr. 135254
- Abhängeset 5m
Art. Nr. 1001950
- Abhängeset 5m
Art. Nr. 1001951
- Abhängeset 5m
Art. Nr. 1001952

Variante	Art. Nr.
Up: 20/20lm 3000/4000K CRI80 Down: 1230/1280lm 3000/4000K CRI80	<input checked="" type="checkbox"/> schwarz 1001889
Up: 20/20lm 3000/4000K CRI80 Down: 1230/1280lm 3000/4000K CRI80	<input type="checkbox"/> weiß 1001893
Up: 20/20lm 3000/4000K CRI80 Down: 1230/1280lm 3000/4000K CRI80	<input checked="" type="checkbox"/> grau 1001894

MEDO 40 AMBIENT
CW, DALI

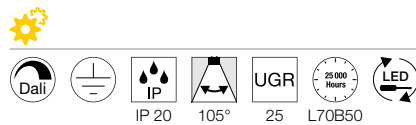
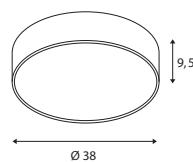
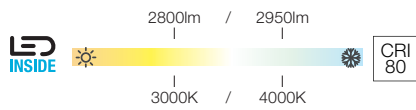
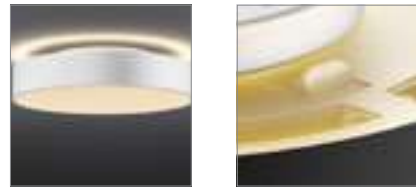

220-240V ~50/60Hz | 700mA
Systemleistung: 30W
Material: Aluminium / Polycarbonat (PC)
• Abhängeset exkl.

Up/Down	2800/2950lm 3000/4000K	

- Abhängeset 1,5m
Art. Nr. 135250
- Abhängeset 1,5m
Art. Nr. 135251
- Abhängeset 1,5m
Art. Nr. 135254
- Abhängeset 5m
Art. Nr. 1001950
- Abhängeset 5m
Art. Nr. 1001951
- Abhängeset 5m
Art. Nr. 1001952

Variante	Art. Nr.
Up: 50/50lm 3000/4000K CRI80 Down: 2750/2900lm 3000/4000K CRI80	<input checked="" type="checkbox"/> schwarz 1001895
Up: 50/50lm 3000/4000K CRI80 Down: 2750/2900lm 3000/4000K CRI80	<input type="checkbox"/> weiß 1001896
Up: 50/50lm 3000/4000K CRI80 Down: 2750/2900lm 3000/4000K CRI80	<input checked="" type="checkbox"/> grau 1001897

MEDO 60 AMBIENT
CW, DALI

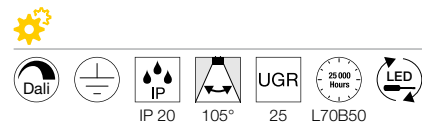
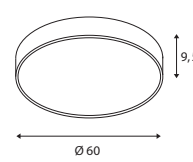
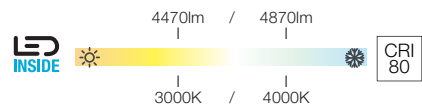

220-240V ~50/60Hz | 1000mA
Systemleistung: 37W
Material: Aluminium / Polycarbonat (PC)
• Abhängeset exkl.

Up/Down	4470/4870lm 3000/4000K	

- Abhängeset 1,5m
Art. Nr. 135250
- Abhängeset 1,5m
Art. Nr. 135251
- Abhängeset 1,5m
Art. Nr. 135254
- Abhängeset 5m
Art. Nr. 1001950
- Abhängeset 5m
Art. Nr. 1001951
- Abhängeset 5m
Art. Nr. 1001952

Variante	Art. Nr.
Up: 120/120lm 3000/4000K CRI80 Down: 4350/4750lm 3000/4000K CRI80	<input checked="" type="checkbox"/> schwarz 1001898
Up: 120/120lm 3000/4000K CRI80 Down: 4350/4750lm 3000/4000K CRI80	<input type="checkbox"/> weiß 1001900
Up: 120/120lm 3000/4000K CRI80 Down: 4350/4750lm 3000/4000K CRI80	<input checked="" type="checkbox"/> grau 1001899

MEDO 90 AMBIENT
CL, DALI

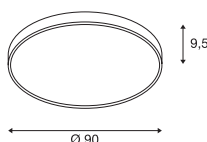
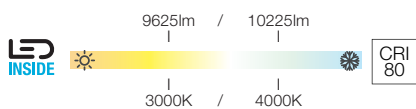
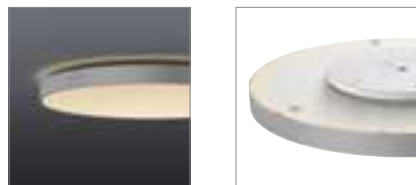

220-240V ~50/60Hz | 1000mA
Systemleistung: 78W
Material: Aluminium / Polycarbonat (PC)
• Abhängeset exkl.

Up/Down	9625/10225lm 3000/4000K	

- Abhängeset 1,5m
Art. Nr. 135250
- Abhängeset 1,5m
Art. Nr. 135251
- Abhängeset 1,5m
Art. Nr. 135254
- Abhängeset 5m
Art. Nr. 1001950
- Abhängeset 5m
Art. Nr. 1001951
- Abhängeset 5m
Art. Nr. 1001952

Variante	Art. Nr.
Up: 125/125lm 3000/4000K CRI80 Down: 9500/10100lm 3000/4000K CRI80	1001890
Up: 125/125lm 3000/4000K CRI80 Down: 9500/10100lm 3000/4000K CRI80	1001891
Up: 125/125lm 3000/4000K CRI80 Down: 9500/10100lm 3000/4000K CRI80	1001892

MEDO 60
CL, quadratisch, DALI

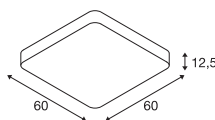
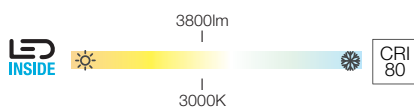

220-240V ~50/60Hz | 1000mA
Systemleistung: 39W
Material: Aluminium / Acryl

1002882	3800lm 3000K	

- Abhängeset 1,5m
Art. Nr. 135250
- Abhängeset 1,5m
Art. Nr. 135251
- Abhängeset 1,5m
Art. Nr. 135254
- Abhängeset 5m
Art. Nr. 1001950
- Abhängeset 5m
Art. Nr. 1001951
- Abhängeset 5m
Art. Nr. 1001952

Variante	Art. Nr.
3800lm 3000K CRI80	1002882



1001891/93/96 + 1001900 260 + 261



1002882 261

PANEL 60
CL, rund, PHASE

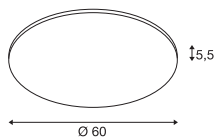
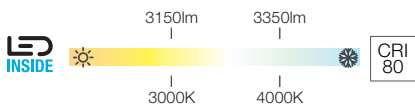

IP 20 110° 22 L70B50 40

220-240V ~50/60Hz | 1000mA
Systemleistung: 42W
Material: Aluminium / Polymethylacrylat (PMMA)

PANEL
CL, 1200x300mm, PHASE

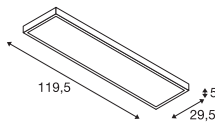
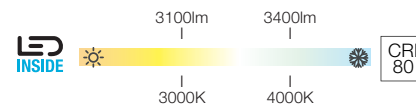
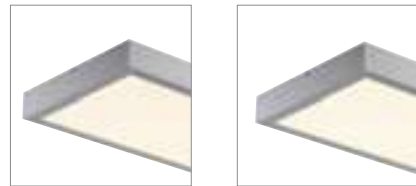

IP 20 90° 19 L70B50 40

220-240V ~50/60Hz | 1000mA
Systemleistung: 45W
Material: Aluminium / Polymethylacrylat (PMMA)

		A → G
1000783, 1000784, 1000785, 1000786	3150lm 3350lm 3000K 4000K	A ↑ G ↓ E

Variante	Art. Nr.
3100lm 3000K CRI80	
<input type="checkbox"/> weiß	1001505
3400lm 4000K CRI80	
<input type="checkbox"/> weiß	1001506
3100lm 3000K CRI80	
<input checked="" type="checkbox"/> grau	1001508
3400lm 4000K CRI80	
<input checked="" type="checkbox"/> grau	1001509

Variante	Art. Nr.
3150lm 3000K CRI80	
<input type="checkbox"/> weiß	1000783
3350lm 4000K CRI80	
<input type="checkbox"/> weiß	1000784
3150lm 3000K CRI80	
<input checked="" type="checkbox"/> grau	1000785
3350lm 4000K CRI80	
<input checked="" type="checkbox"/> grau	1000786

1000783 262





1000786 262

PANEL 60
CL, rund, DALI

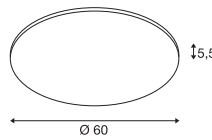
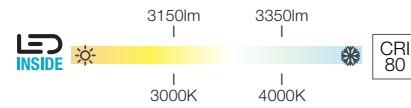

100-277V ~50/60Hz | 1000mA
Systemleistung: 43W
Material: Aluminium / Polymethylacrylat (PMMA)



1003040, 1003041, 1003042, 1003043	3150lm 3350lm 3000K 4000K	

Variante	Art. Nr.
3150lm 3000K CRI80	
<input type="checkbox"/> weiß	1003040
3350lm 4000K CRI80	
<input type="checkbox"/> weiß	1003041
3150lm 3000K CRI80	
<input checked="" type="checkbox"/> grau	1003042
3350lm 4000K CRI80	
<input checked="" type="checkbox"/> grau	1003043

PANEL
CL, 1200x300mm, DALI

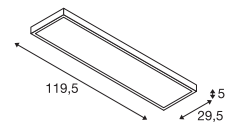
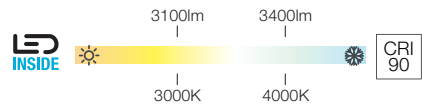
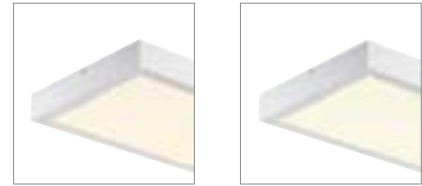

100-277V ~50/60Hz | 1000mA
Systemleistung: 43W
Material: Aluminium / Polymethylacrylat (PMMA)



1003052, 1003053, 1003054, 1003055	3100lm 3400lm 3000K 4000K	

Variante	Art. Nr.
3100lm 3000K CRI90	
<input type="checkbox"/> weiß	1003052
3400lm 4000K CRI80	
<input type="checkbox"/> weiß	1003053
3100lm 3000K CRI80	
<input checked="" type="checkbox"/> grau	1003054
3400lm 4000K CRI80	
<input checked="" type="checkbox"/> grau	1003055

Q-LINE®
CL, 1m, BAP, PHASE

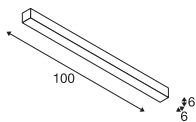
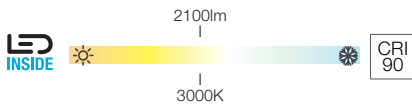

220-240V ~50/60Hz | 900mA
Systemleistung: 46W
Material: Aluminium / Kunststoff

Q-LINE®
CL, 1m, BAP, PHASE

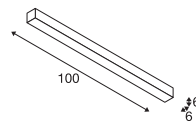
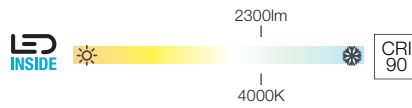

220-240V ~50/60Hz | 900mA
Systemleistung: 46W
Material: Aluminium / Kunststoff

1000686, 1000685	2100lm 3000K	

1000689, 1000688	2300lm 4000K	

Variante	Art. Nr.
2100lm 3000K CRI90	
■ schwarz	1000686
2100lm 3000K CRI90	
□ weiß	1000685

Variante	Art. Nr.
2300lm 4000K CRI90	
■ schwarz	1000689
2300lm 4000K CRI90	
□ weiß	1000688

1000689 264





1000692 265

Q-LINE®
CL, 2m, BAP, PHASE

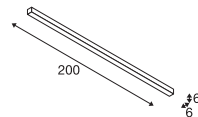
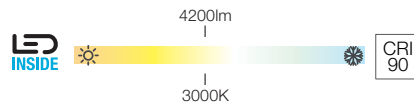

220-240V ~50/60Hz | 900mA
Systemleistung: 93W
Material: Aluminium / Kunststoff

Q-LINE®
CL, 2m, BAP, PHASE

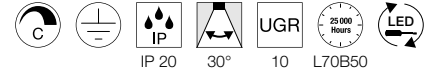
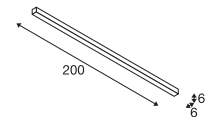
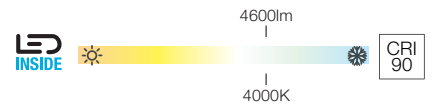

220-240V ~50/60Hz | 900mA
Systemleistung: 93W
Material: Aluminium / Kunststoff



		A → G
1000692, 1000691	4200lm 3000K	A F

Variante	Art. Nr.
4200lm 3000K CRI90	
■ schwarz	1000692
4200lm 3000K CRI90	
□ weiß	1000691



		A → G
1000695, 1000694	4600lm 4000K	A F

Variante	Art. Nr.
4600lm 4000K CRI90	
■ schwarz	1000695
4600lm 4000K CRI90	
□ weiß	1000694

TRILEDO
CL, single, quadratisch, QPAR51

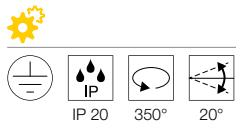
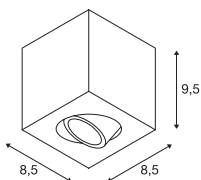

220-240V ~50/60Hz
Material: Aluminium

GU10 <10W
Ø: 5 cm L: 5,5 cm

LED GU10 51mm | 4W | 36°
3000K | 280lm | EEK=F
4kWh/1000h

Art. Nr. 1004973

Variante	Art. Nr.
1xGU10	
■ schwarz	1002013
1xGU10	
□ weiß	1002015
1xGU10	
■ aluminium	1002004

TRILEDO
CL, double, quadratisch, QPAR51

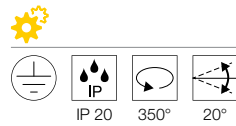
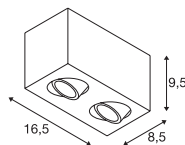

220-240V ~50/60Hz
Material: Aluminium

GU10 <10W
Ø: 5 cm L: 5,5 cm

LED GU10 51mm | 4W | 36°
2700K | 270lm | EEK=G
4kWh/1000h

Art. Nr. 1004972

Variante	Art. Nr.
2xGU10	
■ schwarz	1002005
2xGU10	
□ weiß	1002006

TRILEDO
CL, single, rund, QPAR51

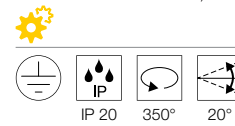
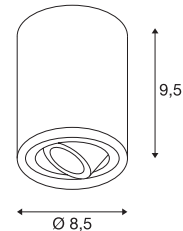

220-240V ~50/60Hz
Material: Aluminium

GU10 <10W
Ø: 5 cm L: 5,5 cm

LED GU10 51mm | 6W | 38°
2700K | 450lm | EEK=G
6kWh/1000h

Art. Nr. 1005075

Variante	Art. Nr.
1xGU10	
■ schwarz	1002010
1xGU10	
□ weiß	1002011
1xGU10	
■ aluminium	1002012



113940 269



113930 269



TRILEDO
CL, single, quadratisch

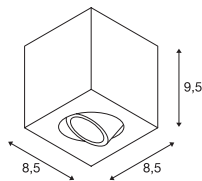
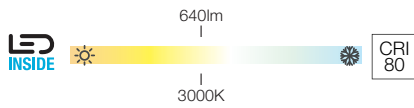

100-240V ~50/60Hz | 350mA
Systemleistung: 7,6W
Material: Aluminium

TRILEDO
CL, double, quadratisch

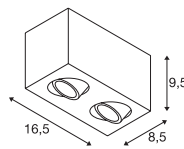

220-240V ~50/60Hz | 350mA
Systemleistung: 14W
Material: Aluminium

TRILEDO
CL, single, rund

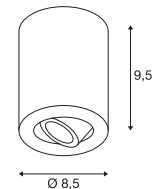
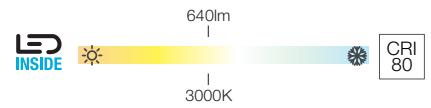

100-240V ~50/60Hz | 350mA
Systemleistung: 7,6W
Material: Aluminium

113940, 113941	640lm 3000K	

Variante	Art. Nr.
640lm 3000K CRI80	
■ schwarz	113940
640lm 3000K CRI80	
□ weiß	113941

1002003, 1002008	1300lm 3000K	

Variante	Art. Nr.
1300lm 3000K CRI80	
■ schwarz	1002003
1300lm 3000K CRI80	
□ weiß	1002008

113930, 113931	640lm 3000K	

Variante	Art. Nr.
640lm 3000K CRI80	
■ schwarz	113930
640lm 3000K CRI80	
□ weiß	113931

SUPROS
CL, Move

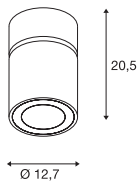
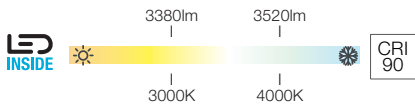

220-240V ~50/60Hz | 950mA
Systemleistung: 36W
Material: Aluminium

SUPROS
CL, Move

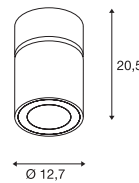
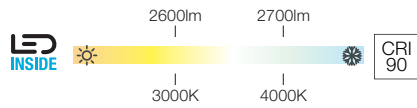

220-240V ~50/60Hz | 750mA
Systemleistung: 31W
Material: Aluminium

1003283, 1003284, 1003285, 1003286	3380lm 3000K 4000K	

1003289, 1003290, 1003287, 1003288	2600lm 2700lm 3000K 4000K	

Reflektor 20° Art. Nr. 114102	
Reflektor 40° Art. Nr. 114104	

Reflektor 20° Art. Nr. 114102	
Reflektor 40° Art. Nr. 114104	

Variante	Art. Nr.
3380lm 3000K CRI90	
■ schwarz	1003283
3380lm 3000K CRI90	
□ weiß	1003284
3520lm 4000K CRI90	
■ schwarz	1003285
3520lm 4000K CRI90	
□ weiß	1003286

Variante	Art. Nr.
2600lm 3000K CRI90	
■ schwarz	1003289
2600lm 3000K CRI90	
□ weiß	1003290
2700lm 4000K CRI90	
■ schwarz	1003287
2700lm 4000K CRI90	
□ weiß	1003288



1003284 270



116331 271

SUPROS 78
CL, PHASE

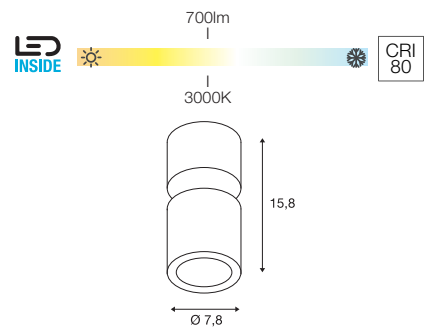

220-240V ~50/60Hz | 250mA
Systemleistung: 12W
Material: Aluminium

		A → G
116330, 116331	700lm 3000K	A G E

-
- Linse 20°
Art. Nr. 116302
 - Linse 40°
Art. Nr. 116304

Variante	Art. Nr.
700lm 3000K CRI80	
schwarz	116330
700lm 3000K CRI80	
<input type="checkbox"/> weiß	116331

117321 273

DESIGNED BY
David Morgan

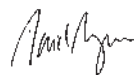

“Excellent light quality from innovative, distinctive and attractive luminaire designs.”



117351 273

OCCULDAS 13
DL, indirekt, PHASE



OCCULDAS 23
DL, indirekt, PHASE

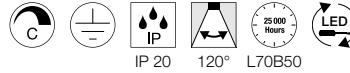
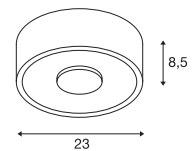
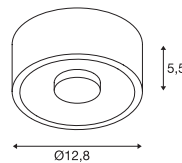
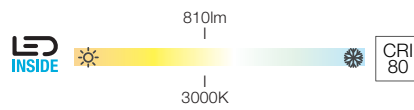

220-240V ~50/60Hz | 350mA
Systemleistung: 15W
Material: Aluminium

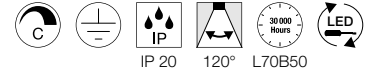

220-240V ~50/60Hz | 700mA
Systemleistung: 24W
Material: Aluminium / Stahl



117351	810lm 3000K	



117321	1500lm 3000K	

Variante Art. Nr.
810lm | 3000K | CRI80
□ weiß 117351

Variante Art. Nr.
1500lm | 3000K | CRI80
□ weiß 117321

ALTRA DICE
CL, QPAR51

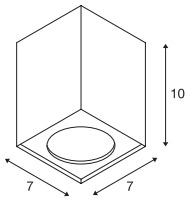

220-240V ~50/60Hz
Material: Aluminium / Stahl



GU10 <35W



LED GU10 51mm | 6W | 38°
2700K | 450lm | EEC=G
6kWh/1000h



Art. Nr. 1005075

Variante	Art. Nr.
1xGU10	
■ schwarz	1002216
1xGU10	
□ weiß	151511
1xGU10	
■ grau / schwarz	151514

ALTRA DICE
CW, double, QPAR51

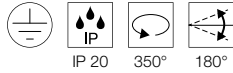
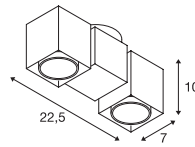

220-240V ~50/60Hz
Material: Aluminium / Stahl



GU10 <50W



LED GU10 51mm | 4W | 36°
3000K | 280lm | EEC=F
4kWh/1000h



Art. Nr. 1004973

Variante	Art. Nr.
2xGU10	
■ schwarz	1002215
2xGU10	
□ weiß	151531
2xGU10	
■ grau / schwarz	151534





117101 275

KARDAMOD
CL, single, quadratisch, QPAR111

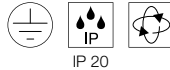
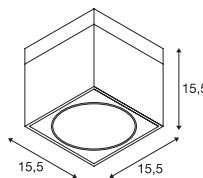

220-240V ~50/60Hz
Material: Stahl



GU10 <75W



QPAR111 | 8W | 38°
2700K | 680lm | EEK=F
8kWh/1000h



Art. Nr. 1005274

Variante	Art. Nr.
1xGU10	
■ schwarz	117100
1xGU10	
□ weiß	117101



117110 275

KARDAMOD
CL, double, quadratisch, QPAR111

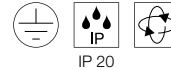
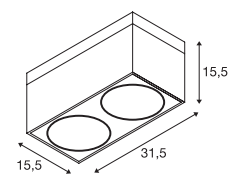
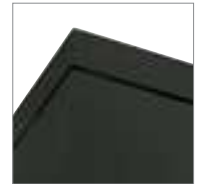

220-240V ~50/60Hz
Material: Stahl



GU10 <75W



QPAR111 | 12,5W | 30°
4000K | 1000lm | EEK=F
13kWh/1000h



Art. Nr. 1005282

Variante	Art. Nr.
2xGU10	
■ schwarz	117110
2xGU10	
□ weiß	117111

SLV FENDA. MIX & MATCH.

MIX & MATCH

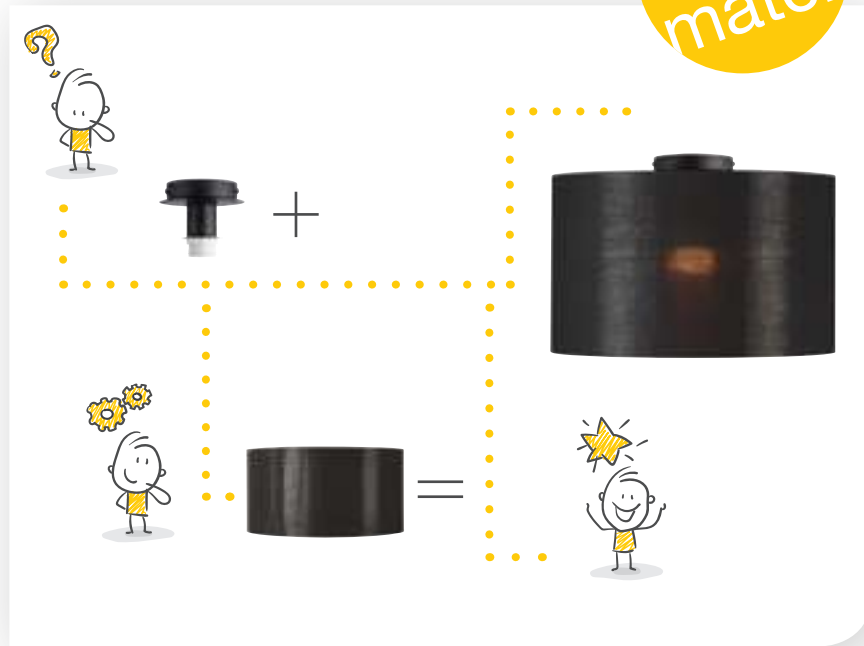

FENDA
Deckenrosette, E27



SOCKET INSIDE <60 W

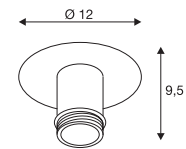

220-240V ~50/60Hz
Material: Stahl



E27 <60W



LED E27 | 13,2W | 220°
2700K | 1300lm | EEK=F
13kWh/1000h



Art. Nr. 1005302

Variante	Art. Nr.
1xE27	
■ schwarz	155550
1xE27	
□ weiß	155551
1xE27	
■ chrom	155552



155552 + 156122 276 + 277



155552 + 156122 276 + 277

FENDA
30 cm, rund

NEW VARIANT



H: 20 cm
Ø: 30 cm
Material: Textil / Stahl

FENDA
45 cm, rund

NEW VARIANT



H: 28 cm
Ø: 45,5 cm
Material: Textil / Stahl

FENDA
Ø 70 cm, rund



H: 36 cm
Ø: 70 cm
Material: Textil / Stahl

• max. 20W



Acrylglasabdeckung
Art. Nr. 156100



Acrylglasabdeckung
Art. Nr. 1000957

Variante	Art. Nr.
■ schwarz / kupfer	155592
□ weiß	155582
■ beige	155583
■ grau	1004774

Variante	Art. Nr.
■ schwarz / kupfer	156122
□ weiß	156111
■ beige	156113
■ grau	1004775

Variante	Art. Nr.
■ schwarz / kupfer	1000580
□ weiß	1000579

TENORA
CL, E27



<23
W

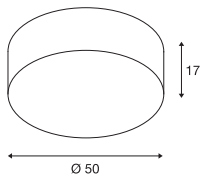

220-240V 50/60Hz
Material: Stahl / Textil



E27 <23W L: 14,8 cm



LED E27 | 9W | 220°
2700K | 800lm | EEK=F
9kWh/1000h



Art. Nr. 1005301

Variante	Art. Nr.
3xE27	
■ schwarz	156050
3xE27	
□ weiß	156051

SOPRANA
CL, E27



<60
W

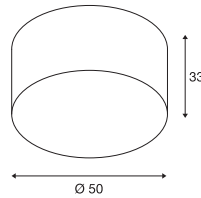

220-240V ~50/60Hz
Material: Stahl / Textil



E27 <60W



LED E27 | 13,2W | 220°
2700K | 1300lm | EEK=F
13kWh/1000h



Art. Nr. 1005302

Variante	Art. Nr.
3xE27	
■ beige	155373



156050 278



155373 278

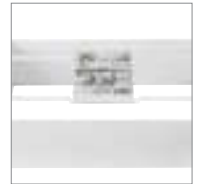

1002945 279

ACCANTO
CL, E27

SOCKET INSIDE <40 W

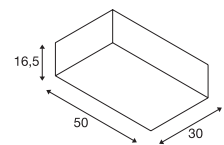

IP 20

220-240V ~50/60Hz
Material: Stahl / Textil



E27 <40W L: 13 cm



LED E27 | 9W | 220°
2700K | 800lm | EEK=F
9kWh/1000h



Art. Nr. 1005301

Variante	Art. Nr.
2xE27	
■ schwarz	1002944 ▼
2xE27	
□ weiß	1002945 ▼

OCULUS
CL, PHASE

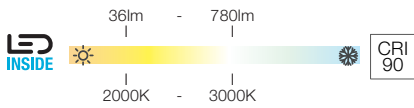

CRI 90

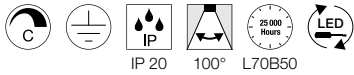
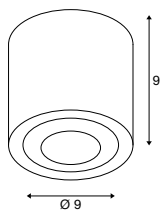

220-240V ~50/60Hz | 250mA
Systemleistung: 11W
Material: Aluminium / Glas

- Additionelle gefrostete Linse inklusive



1004666, 1004667	36-780lm 2000-3000K	

Variante	Art. Nr.
36-780lm 2000-3000K CRI90	
■ schwarz	1004666
36-780lm 2000-3000K CRI90	
□ weiß	1004667

1004666 280

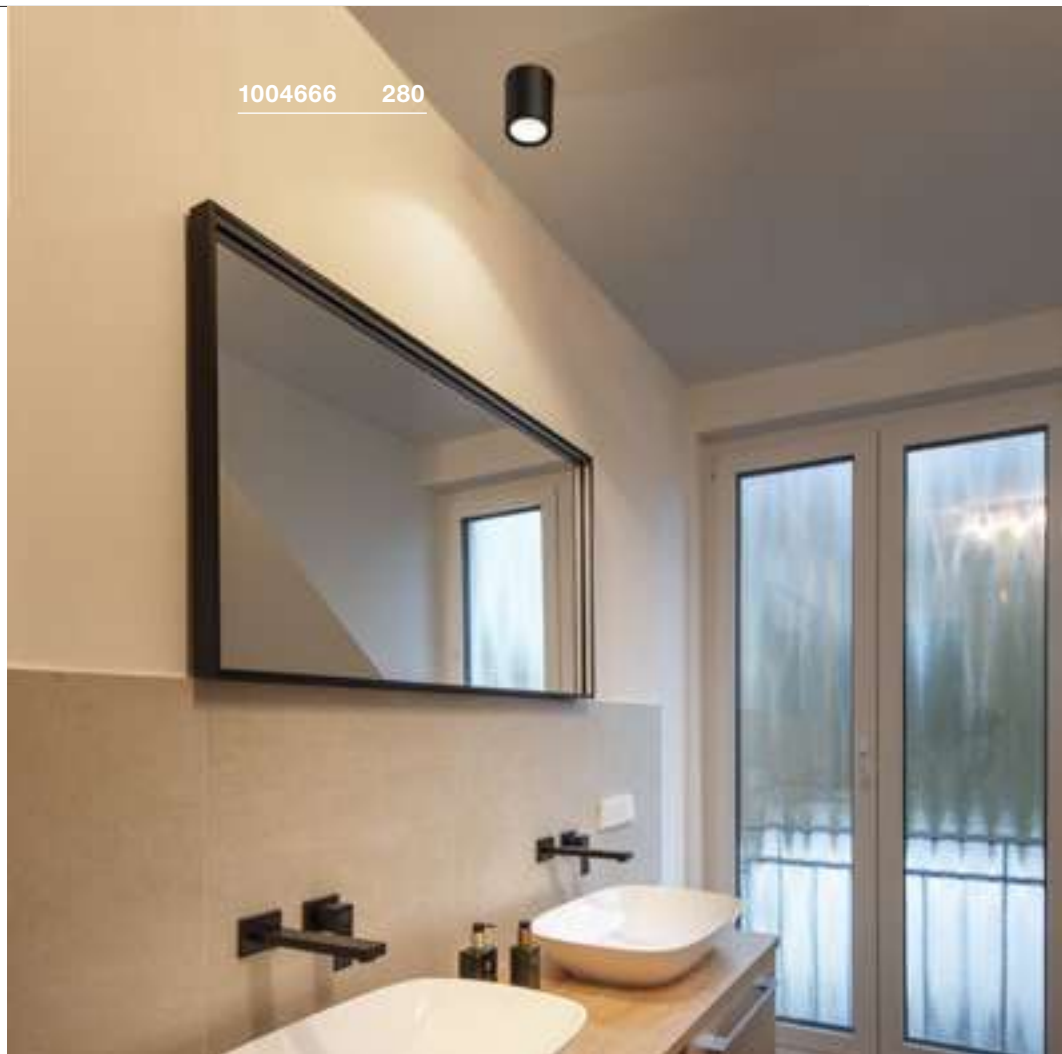

151811 281

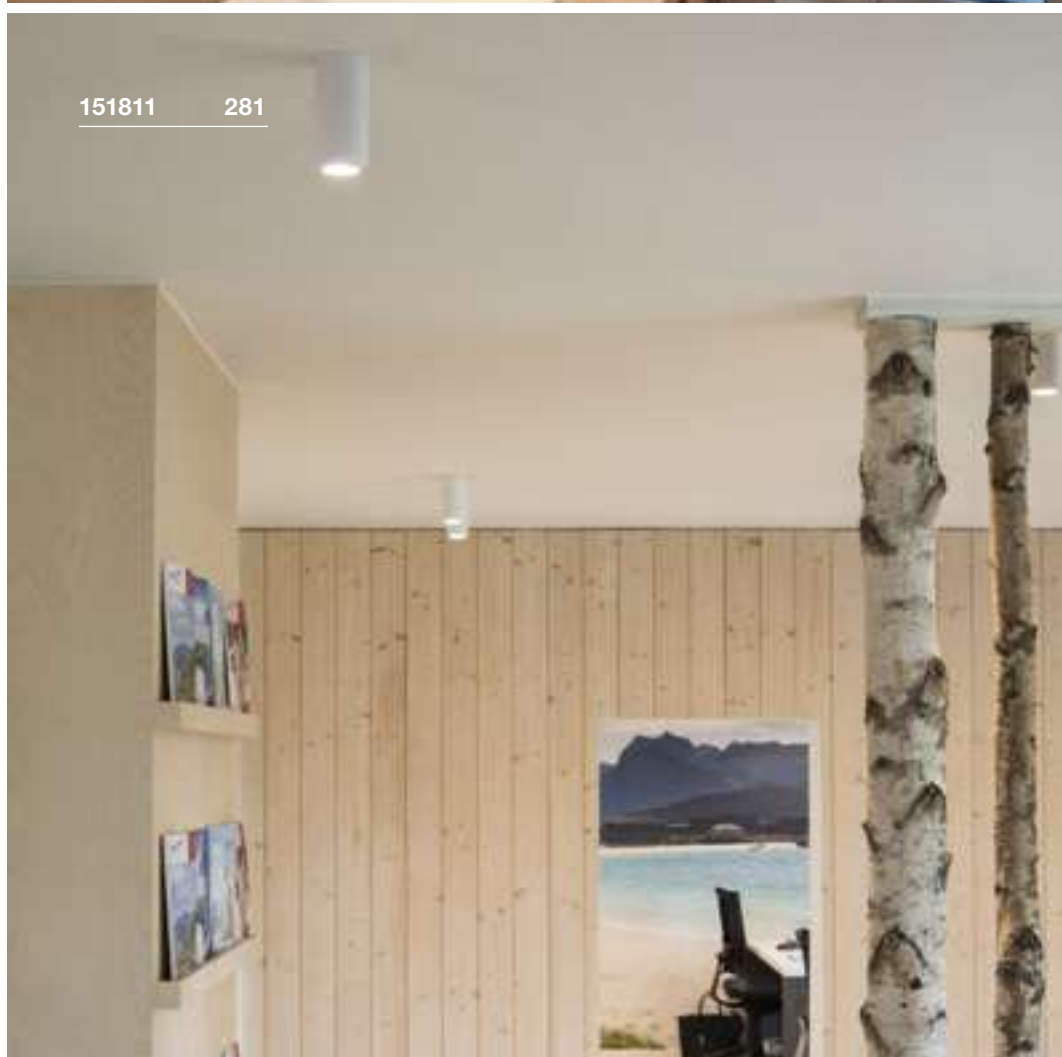

ENOLA B
CL, QPAR51

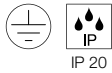
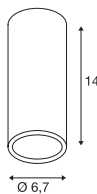

220-240V ~50/60Hz
Material: Aluminium



GU10 <35W L: 8,5 cm



LED GU10 51mm | 4W | 36°
4000K | 290lm | EEK=F
4kWh/1000h



Art. Nr. 1004974



■ Zierring, schwarz
Art. Nr. 151840



Variante	Art. Nr.
1xGU10	
■ schwarz	151810
1xGU10	
□ weiß	151811
1xGU10	
■ gold	151813

ENOLA C
CL

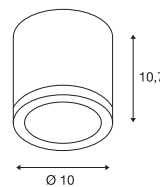
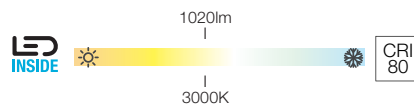

220-240V ~50/60Hz | 500mA
Systemleistung: 11W
Material: Aluminium



Art. Nr.	Light Output	Efficiency
152101	1020lm 3000K	A → G

ENOLA C
CL, PHASE

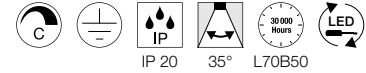
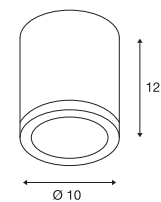
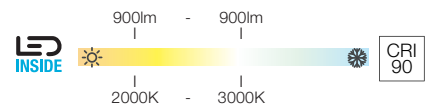

220-240V ~50/60Hz | 350mA
Systemleistung: 15W
Material: Aluminium / Glas



Art. Nr.	Light Output	Efficiency
1000631	900lm 2000-3000K	A → G

Variante	Art. Nr.
900lm 2000-3000K CRI90	
□ weiß	1000631

PLASTRA
CL, QPAR51



PLASTRA
CL, PHASE



PLASTRA 105
CL, E27

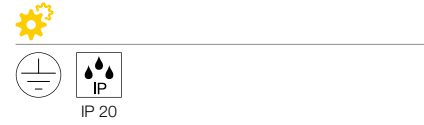
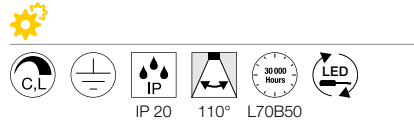
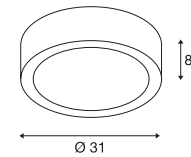
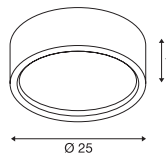
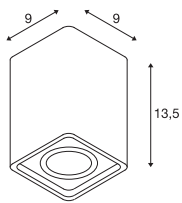
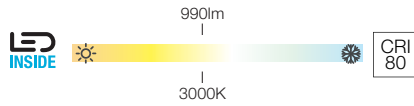
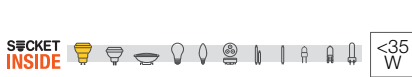
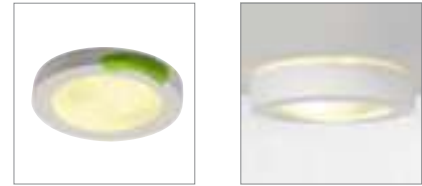
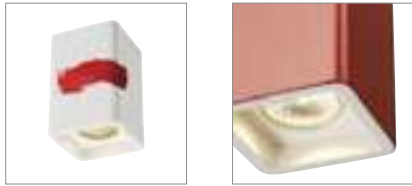

220-240V ~50/60Hz
Material: Gips / Stahl

220-240V ~50/60Hz | 350mA
Systemleistung: 15W
Material: Gips / Stahl

220-240V ~50/60Hz
Material: Gips / Glas

GU10 <35W

		A → G
148005	990lm 3000K	A ↑ G ↓ F

E27 <25W
Ø: 5 cm L: 14 cm

LED GU10 51mm | 4W | 36°
3000K | 280lm | EEK=F
4kWh/1000h

Art. Nr. 1004973

LED E27 | 8W | 240°
3000K | 880lm | EEK=E
8kWh/1000h

Art. Nr. 1005289

Variante	Art. Nr.
1xGU10	
<input type="checkbox"/> weiß	148004

Variante	Art. Nr.
990lm 3000K CRI80	
<input type="checkbox"/> weiß	148005

Variante	Art. Nr.
2xE27	
<input type="checkbox"/> weiß	148001

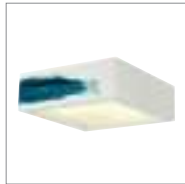
PLASTRA 104
CL, E27













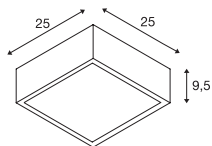

<25
W

IP 20

220-240V ~50/60Hz
Material: Gips / Glas



E27 <25W
Ø: 5 cm L: 14 cm



LED E27 | 8W | 240°
3000K | 880lm | EEK=E
8kWh/1000h



Art. Nr. 1005289

Variante	Art. Nr.
2xE27	
<input type="checkbox"/> weiß	148002



FERA 25
CL, DALI

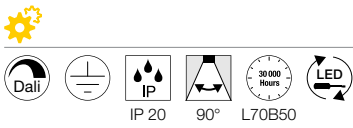
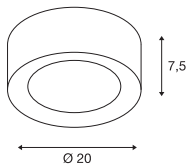
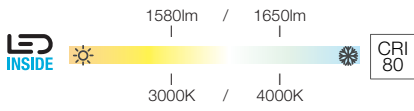

220-240V ~50/60Hz | 500mA
Systemleistung: 19,5W
Material:
Polycarbonat (PC) / Polymethylacrylat (PMMA)

1002968, 1002967	1580/1650lm 3000/4000K	

Variante	Art. Nr.
1580/1650lm 3000/4000K CRI80	
■ schwarz	1002968
1580/1650lm 3000/4000K CRI80	
□ weiß / gefrostet	1002967



1002968 284

161461 285

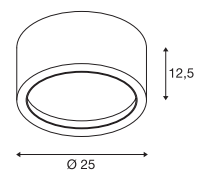
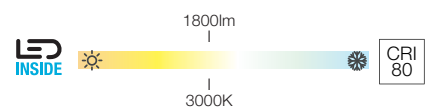
FERA 25
CL





IP 20 100° L70B50

220-240V ~50/60Hz | 550mA

Systemleistung: 23W

Material: Aluminium / Polystrol (PS)



		
1001939, 161461	1800lm 3000K	

Variante	Art. Nr.
1800lm 3000K CRI80	
■ schwarz	1001939
1800lm 3000K CRI80	
□ weiß	161461

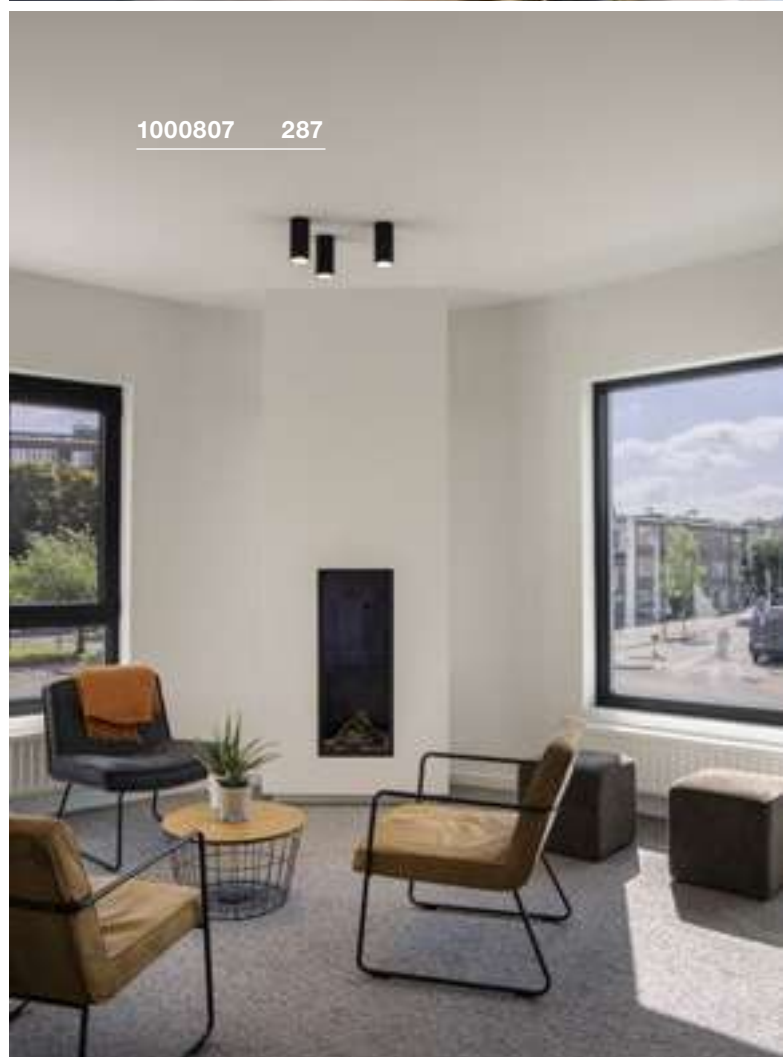

ASTINA
CL, QPAR51

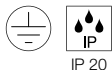
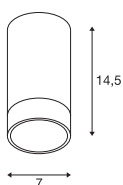

220-240V ~50/60Hz
Material: Aluminium

GU10 <10W



LED GU10 51mm | 4W | 36°
2700K | 270lm | EEK=G
4kWh/1000h



Art. Nr. 1004972

Variante	Art. Nr.
1xGU10	
■ schwarz	1002936
1xGU10	
□ weiß	1002934
1xGU10	
■ grau	1002935

NAGY 75
CL, QPAR51

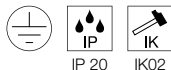
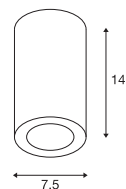

220-240V ~50/60Hz
Material: Gips

GU10 <10W



LED GU10 51mm | 4W | 36°
3000K | 280lm | EEK=F
4kWh/1000h



Art. Nr. 1004973

Variante	Art. Nr.
1xGU10	
□ weiß	1002965

ANELA
CL, PHASE

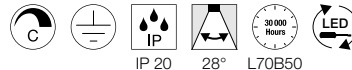
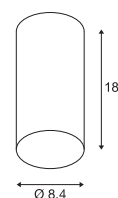

220-240V ~50/60Hz | 500mA
Systemleistung: 10W
Material: Aluminium

- Lichtstrom mit Reflektor 1000809 = 500lm/
Lichtstrom mit Reflektor 1000810 = 620lm/
Lichtstrom mit Reflektor 1000811 = 220lm/
Lichtstrom mit Reflektor 1000812 = 600lm



Art. Nr.	220-750lm 3000K	A → G
1000807, 1000808		A → G



- Reflektor 28°
Art. Nr. 1000809
- Reflektor 28°
Art. Nr. 1000810
- Reflektor 28°
Art. Nr. 1000811
- Reflektor 28°
Art. Nr. 1000812

Variante	Art. Nr.
220-750lm 3000K CRI90	
■ schwarz	1000807
220-750lm 3000K CRI90	
□ weiß	1000808

MARONA
WL, PHASE

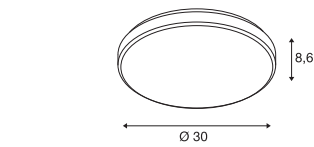
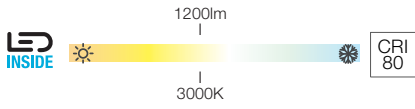

IP 20 120° L70B50

200-240V ~50/60Hz | 430mA
Systemleistung: 15W
Material: Polymethylacrylat (PMMA) / Stahl

BATO 45
CW, E27



SCKET INSIDE <60 W

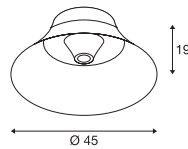

IP 20

220-240V ~50/60Hz
Material: Aluminium / Stahl

155156	1200lm 3000K	

E27 <60W

LED E27 | 7,5W | 180°
2700K | 720lm | EEK=F
8kWh/1000h

Art. Nr. 1005305



Variante	Art. Nr.
1200lm 3000K CRI80 ■ grau	155156

Variante	Art. Nr.
1xE27	
■ schwarz	1000443
1xE27	
■ gold	1000445





1000443 288

ROTOBALL 25
CL, E27



ROTOBALL 40
CL, E27

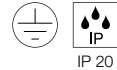
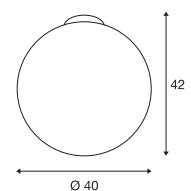
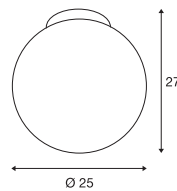

230V ~50Hz
Material: Stahl / Polyethylen (PE)



230V ~50Hz
Material: Stahl / Polyethylen (PE)

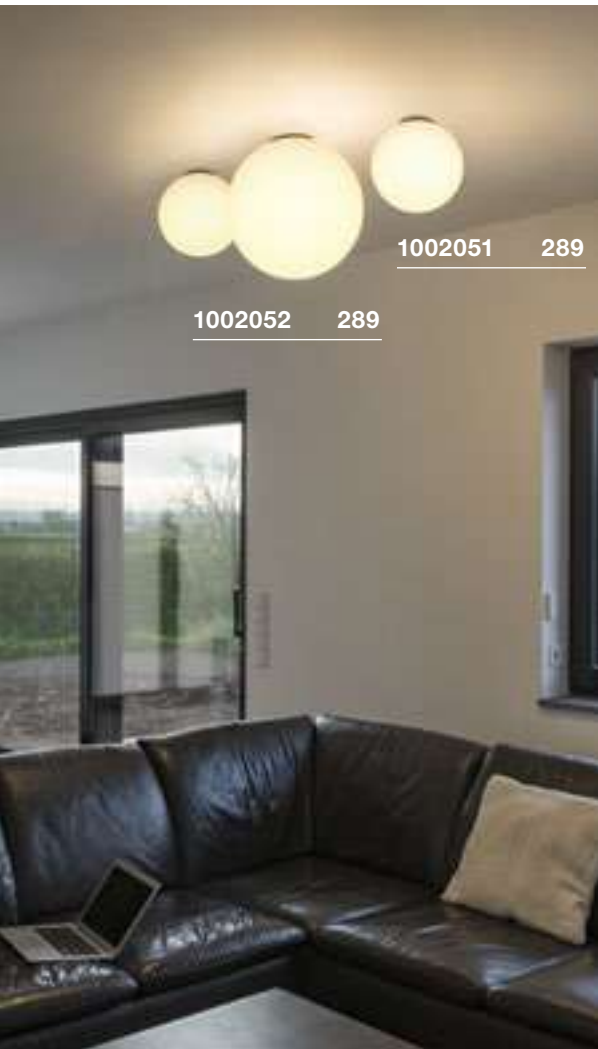

1002051 289

1002052 289



E27 <24W
Ø: 6,5 cm



LED E27 | 9W | 220°
2700K | 800lm | EEK=F
9kWh/1000h

Art. Nr. 1005301



E27 <24W
Ø: 9,5 cm



LED E27 | 13,2W | 220°
2700K | 1300lm | EEK=F
13kWh/1000h

Art. Nr. 1005302

Variante	Art. Nr.
1xE27	
<input type="checkbox"/> weiß	1002051

Variante	Art. Nr.
1xE27	
<input type="checkbox"/> weiß	1002052 ▼

FÜR STRAHLENDE AUFTRITTE.

WAND- UND DECKENLEUCHTEN KOMBINIEREN.

Während Deckenleuchten in Sachen Licht den Ton angeben, setzen Wandleuchten individuelle Akzente. Für eine ganzheitliche Lichtlösung ist deshalb eine Kombination aus beidem ideal – und die bietet so viele Variationsmöglichkeiten, dass der Kreativität keine Grenzen gesetzt sind.



1002919 294

Wand- und Deckenleuchten aus dem NUMINOS®
Down- und Spotlightsystem finden Sie auf den Seiten
72 bis 73. Oder ganz einfach online konfigurieren unter:
www.numinos.slv.com

1006093 + 1006170 78 + 79





WAND- UND DECKENLEUCHTEN

 294	 294	 295	 296	 296	 296	 298	 299
 299	 300	 300	 300	 303	 303	 303	 303
 304	 304	 304	 304	 307	 307	 307	 308
 308	 308	 311	 311	 311	 312	 312	 312
 312	 315	 315	 315	 315	 316	 316	 316
 316	 318	 319	 319	 319	 320	 320	 320
 322	 322	 323	 323	 326	 326	 326	 329
 329	 329	 330	 330	 332	 332	 333	 334
 334	 336	 337	 337	 339	 339	 340	 340
 341							



Weitere Leuchten und Varianten finden Sie online unter www.slv.com
 Herstellerangaben unserer Leuchtmittelempfehlungen finden Sie im Kapitel Leuchtmittel ab Seite 808

ONE 40
CW, DALI



ONE 60
WL, DALI

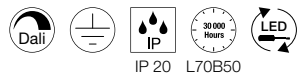
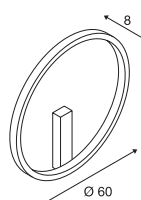
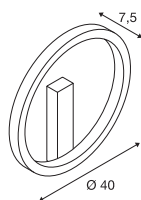
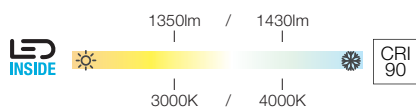
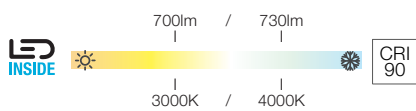

220-240V ~50/60Hz | 350mA
Systemleistung: 14W
Material: Aluminium / Stahl

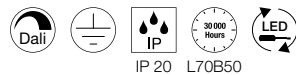

220-240V ~50/60Hz | 600mA
Systemleistung: 24W
Material: Aluminium / Stahl



1002915, 1002917	700/730lm 3000/4000K	



1002918, 1002919	1350/1430lm 3000/4000K	

Variante	Art. Nr.
700/730lm 3000/4000K CRI90 Ø: 40 cm	
■ schwarz	1002915
700/730lm 3000/4000K CRI90 Ø: 40 cm	
□ weiß	1002917

Variante	Art. Nr.
1350/1430lm 3000/4000K CRI90 Ø: 60 cm	
■ schwarz	1002918
1350/1430lm 3000/4000K CRI90 Ø: 60 cm	
□ weiß	1002919

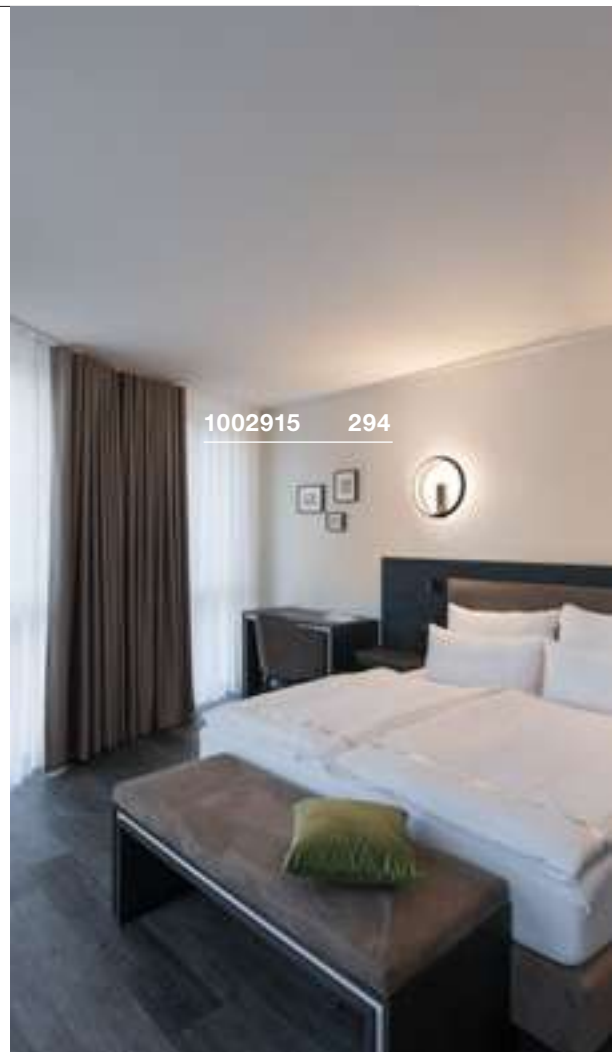

1002915 294



1002919 294



1002915 294

MALANG
CW

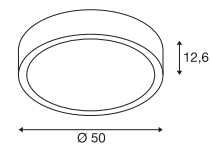
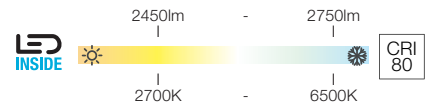
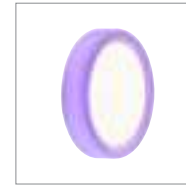

IP 20 110° 19 L70B50

100-240V ~50/60Hz | 24V
Systemleistung: 39W
Material: Aluminium / Polyethylen (PE)

- Steuerbar und dimmbar mit SLV Valetto Fernbedienung 1002994 oder Gateway 1002411
- Ringlicht und Panel sind getrennt steuerbar (Zigbee 3.0)



Die Informationen zur Energieeffizienzklasse für dieses Produkt lagen bei Druck noch nicht vor. Die aktuellsten Produktdaten finden Sie jederzeit unter www.slv.com



- Abhängeset 1,5m
Art. Nr. 135250
- Abhängeset 1,5m
Art. Nr. 135251
- Abhängeset 1,5m
Art. Nr. 135254
- Abhängeset 5m
Art. Nr. 1001950
- Abhängeset 5m
Art. Nr. 1001951
- Abhängeset 5m
Art. Nr. 1001952
- SLV VALETO® | Fernbedienung, CCT/RGBW
Art. Nr. 1002994

Variante	Art. Nr.
Ring: 350lm RGB+W (3000K) CRI>80	
Panel: 2100-2400lm 2700-6500K CRI>80	
□ weiß	1002858



1002858 295

OCULUS
CW, PHASE

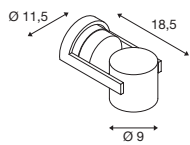
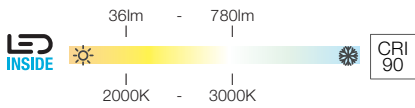

C | IP 20 | 100° | L70B50 | 160° | 180°

220-240V ~50/60Hz | 250mA
Systemleistung: 11W
Material: Aluminium / Glas

• zusätzliche gefrostete Linse inklusive

KARPO 30
CW, single

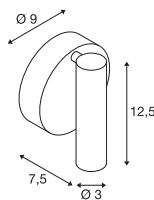
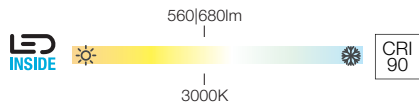
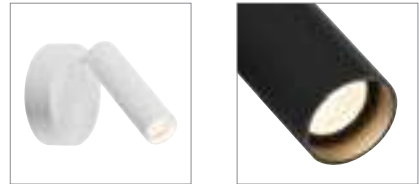

IP 20 | 40° | L70B50 | 350° | 90°

220-240V ~50/60Hz | 500mA
Systemleistung: 9,3W
Material: Aluminium / Stahl

KARPO 30
CW, single, PHASE

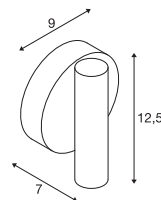
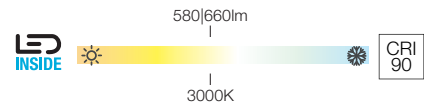
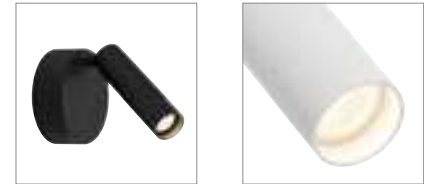

C | IP 20 | 40° | L70B50 | 350° | 90°

220-240V ~50/60Hz | 500mA
Systemleistung: 9W
Material: Aluminium / Stahl

1004664, 1004665	36-780lm 2000-3000K	

Variante	Art. Nr.
36-780lm 2000-3000K CRI90	
■ schwarz	1004664
36-780lm 2000-3000K CRI90	
□ weiß	1004665

152330, 152331	560lm 680lm 3000K	

Variante	Art. Nr.
560lm 3000K CRI90	
■ schwarz	152330
680lm 3000K CRI90	
□ weiß	152331

1001495, 1001496	580lm 660lm 3000K	

Variante	Art. Nr.
580lm 3000K CRI90	
■ schwarz	1001495
660lm 3000K CRI90	
□ weiß	1001496

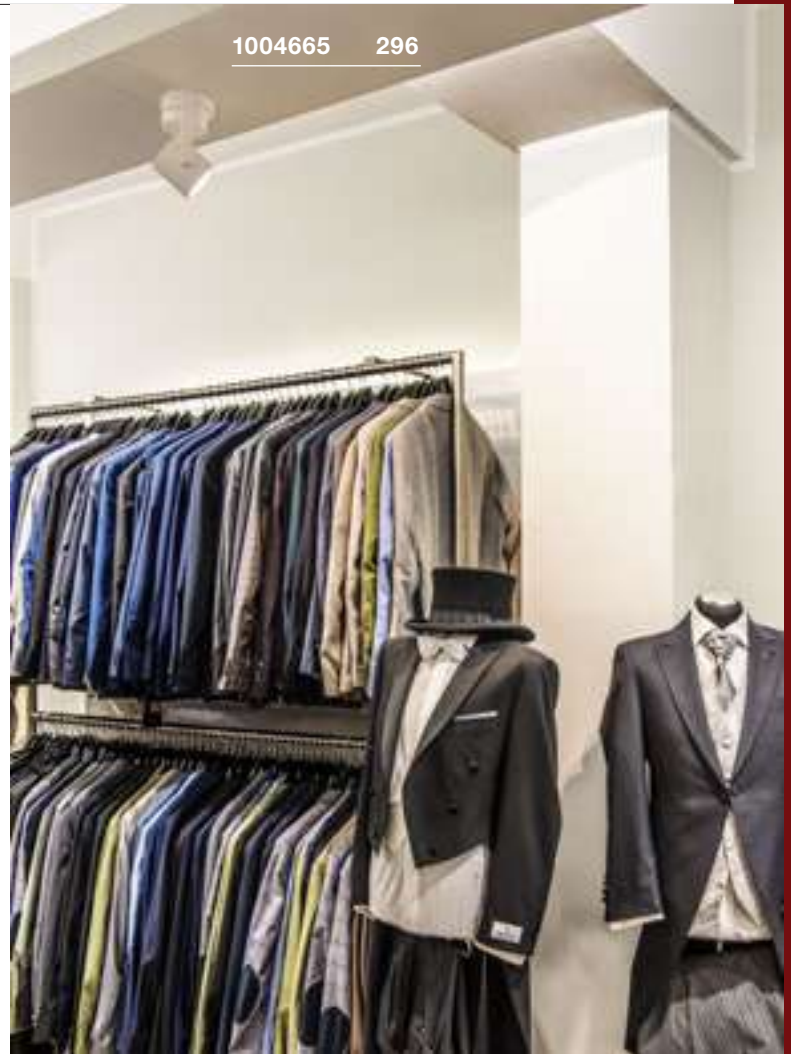

TOTHEE
CW, PHASE

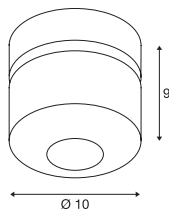
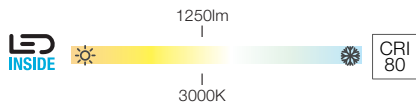

220-240V ~50/60Hz | 350mA
Systemleistung: 17W
Material: Aluminium / Kunststoff



1000426, 1000427	1250lm 3000K	

Variante	Art. Nr.
1250lm 3000K CRI80	
■ schwarz	1000426
1250lm 3000K CRI80	
■ weiß / schwarz	1000427

1000247 298





156501 299



156510 299

HELIA
CW, single, PHASE



HELIA
CW, double, PHASE

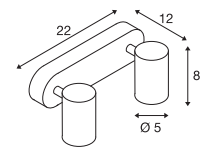
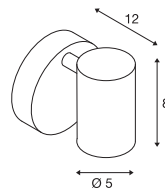
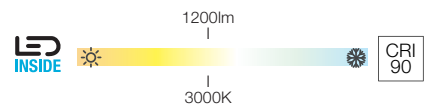
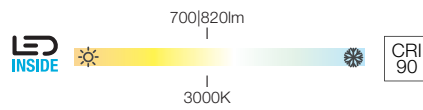

220-240V ~50/60Hz | 500mA
Systemleistung: 10W
Material: Aluminium

220-240V ~50/60Hz | 500mA
Systemleistung: 17W
Material: Aluminium

156500, 156501	700lm 820lm 3000K	

156510, 156511	1200lm 3000K	

Variante	Art. Nr.
700lm 3000K CRI90	
■ schwarz	156500
820lm 3000K CRI90	
□ weiß	156501

Variante	Art. Nr.
1200lm 3000K CRI90	
■ schwarz	156510
1200lm 3000K CRI90	
□ weiß	156511

NOBLO
CW, PHASE

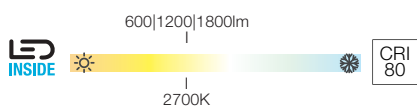

220-240V ~50/60Hz | 350mA
Material: Aluminium



NOBLO
CW, single, PHASE

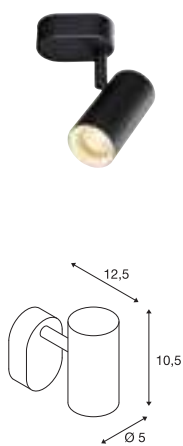

1002969, 1002970, 1002971	600lm 2700K	

Variante	Art. Nr.
600lm 2700K CRI80 ■ schwarz	1002969
600lm 2700K CRI80 □ weiß	1002970
600lm 2700K CRI80 ■ silber	1002971

NOBLO
CW, double, PHASE

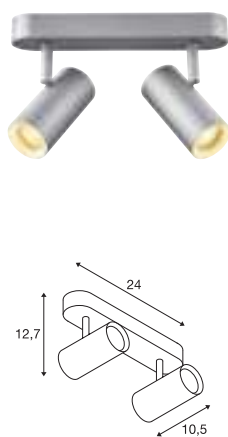

1002973, 1002974, 1002975	1200lm 2700K	

Variante	Art. Nr.
1200lm 2700K CRI80 ■ schwarz	1002973
1200lm 2700K CRI80 □ weiß	1002974
1200lm 2700K CRI80 ■ silber	1002975

NOBLO
CW, triple, PHASE

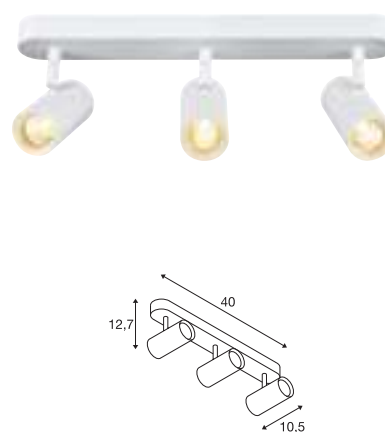

1002976, 1002977, 1002978	1800lm 2700K	

Variante	Art. Nr.
1800lm 2700K CRI80 ■ schwarz	1002976
1800lm 2700K CRI80 □ weiß	1002977
1800lm 2700K CRI90 ■ silber	1002978



1002974 300





1000136 303

1000130 303

KALU
CW, PHASE

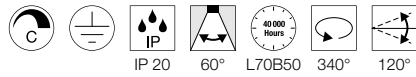
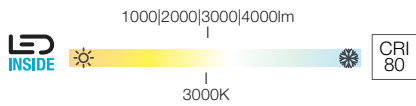

220-240V ~50/60Hz | 350mA
Material: Aluminium / Polycarbonat (PC)

KALU
CW, single, PHASE

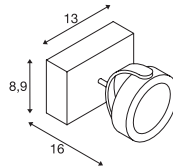

1000127, 1000128	1000lm 3000K	

Variante	Art. Nr.
1000lm 3000K 60° CRI80	
■ schwarz	1000127
■ 1000lm 3000K 60° CRI80	
■ weiß / schwarz	1000128

KALU
CW, double, PHASE

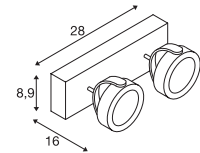

1000129, 1000130	2000lm 3000K	

Variante	Art. Nr.
2000lm 3000K 60° CRI80	
■ schwarz	1000129
■ 2000lm 3000K 60° CRI80	
■ weiß / schwarz	1000130



KALU
CW, triple, PHASE

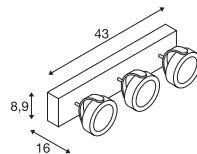

1000131, 1000132	3000lm 3000K	

Variante	Art. Nr.
3000lm 3000K 60° CRI80	
■ schwarz	1000131
■ 3000lm 3000K 60° CRI80	
■ weiß / schwarz	1000132

KALU
CW, quad, PHASE

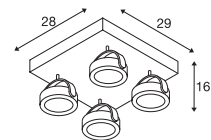

1000135, 1000136	4000lm 3000K	

Variante	Art. Nr.
4000lm 3000K 60° CRI80	
■ schwarz	1000135
■ 4000lm 3000K 60° CRI80	
■ weiß / schwarz	1000136

KALU
CW, QPAR111

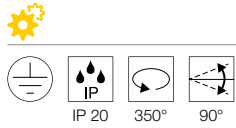

220-240V ~50/60Hz
Material: Aluminium

GU10 <75W

QPAR111 | 8W | 38°
2700K | 680lm | EEK=F
8kWh/1000h



Art. Nr. 1005274

KALU
CW, single, QPAR111

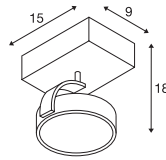

Variante	Art. Nr.
1xGU10	
■ schwarz	1000702
1xGU10	
□ weiß	147301
1xGU10	
■ aluminium	147306

KALU
CW, double, QPAR111

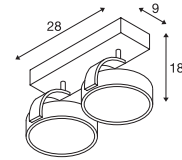

Variante	Art. Nr.
2xGU10	
■ schwarz	1000703
2xGU10	
□ weiß	147311
2xGU10	
■ aluminium	147316

KALU
CW, triple, QPAR111

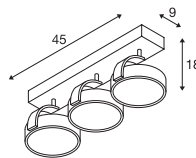

Variante	Art. Nr.
3xGU10	
■ schwarz	1000704
3xGU10	
□ weiß	147321
3xGU10	
■ aluminium	147326

KALU
CW, quad, QPAR111

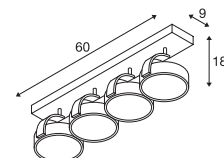

Variante	Art. Nr.
4xGU10	
■ schwarz	1002023
4xGU10	
□ weiß	1002024
4xGU10	
■ aluminium	1002025





1002024 304

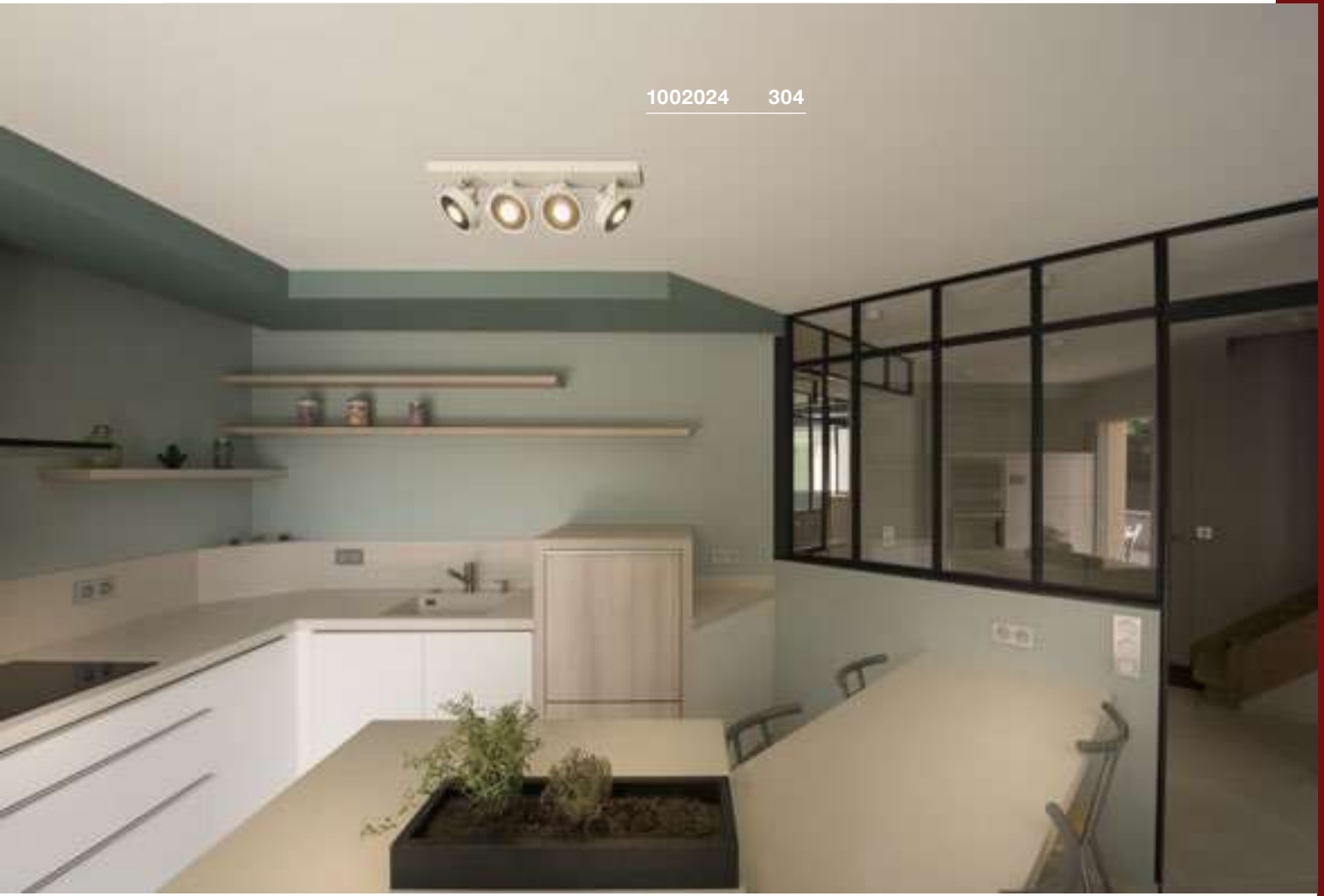

1000702 304



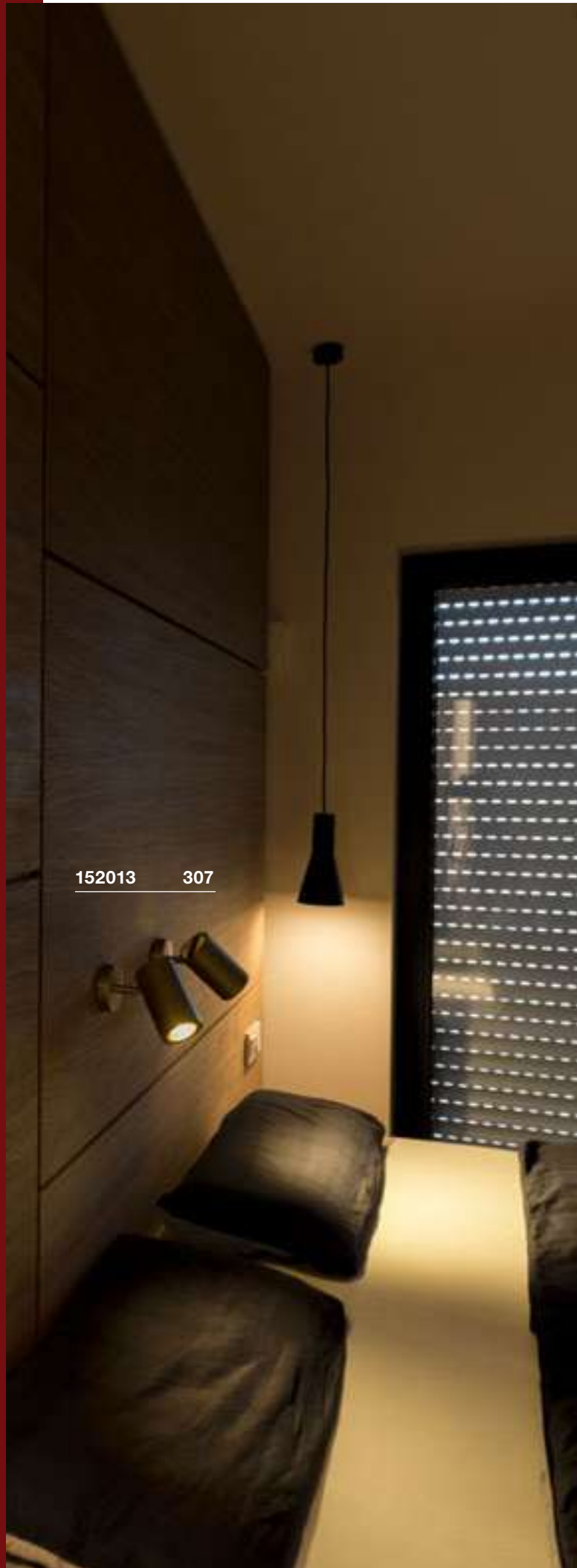

ENOLA B
CW, single, QPAR51

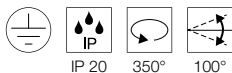
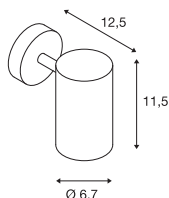

220-240V ~50/60Hz
Material: Aluminium / Stahl

- Zierring in Leuchtenfarbe inkl.
- Optionaler schwarzer Zierring als Zubehör erhältlich.



GU10 <50W L: 6,7 cm



LED GU10 51mm | 4W | 36°
3000K | 280lm | EEK=F
4kWh/1000h



Art. Nr. 1004973



■ Zierring, schwarz
Art. Nr. 151840



Variante	Art. Nr.
1xGU10	
■ schwarz	152010
1xGU10	
□ weiß	152011
1xGU10	
■ gold	152013

ENOLA B
CW, double, QPAR51

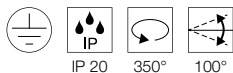
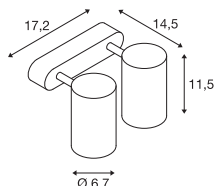

220-240V ~50/60Hz
Material: Aluminium / Stahl

- Zierring in Leuchtenfarbe inkl.
- Optionaler schwarzer Zierring als Zubehör erhältlich.



GU10 <50W L: 6,7 cm



LED GU10 51mm | 4W | 36°
4000K | 290lm | EEK=F
4kWh/1000h



Art. Nr. 1004974



■ Zierring, schwarz
Art. Nr. 151840



Variante	Art. Nr.
2xGU10	
■ schwarz	152020
2xGU10	
□ weiß	152021
2xGU10	
■ gold	152023

ENOLA B
CW, double, QPAR51

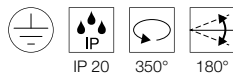
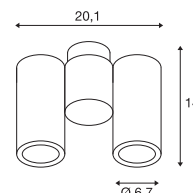

220-240V ~50/60Hz
Material: Aluminium / Stahl

- Zierring in Leuchtenfarbe inkl.
- Optionaler schwarzer Zierring als Zubehör erhältlich.



GU10 <50W L: 8 cm



LED GU10 51mm | 6W | 38°
3000K | 470lm | EEK=F
6kWh/1000h



Art. Nr. 1005079



■ Zierring, schwarz
Art. Nr. 151840



Variante	Art. Nr.
2xGU10	
■ schwarz	151830
2xGU10	
□ weiß	151831

ALTRA DICE
CW, double, QPAR51

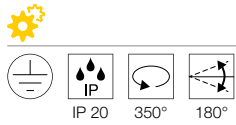
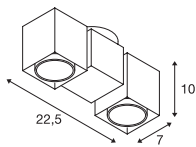

220-240V ~50/60Hz
Material: Aluminium / Stahl

SPOT 79
CW, QPAR51

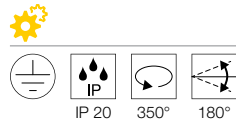
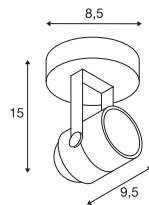

220-240V ~50/60Hz
Material: Aluminium

GU10 <50W
Ø: 5 cm L: 5,7 cm

LED GU10 51mm | 4W | 36°
2700K | 270lm | EEK=G
4kWh/1000h

Art. Nr. 1004972

Variante	Art. Nr.
1xGU10	
■ schwarz	132020
1xGU10	
□ weiß	132021
1xGU10	
■ grau	132024

INDA
CW, QPAR51

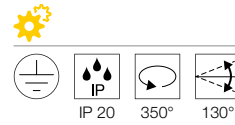
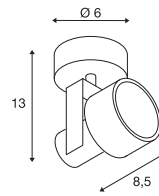

220-240V ~50/60Hz
Material: Aluminium

GU10 <50W
Ø: 5 cm L: 5,7 cm

LED GU10 51mm | 6W | 38°
3000K | 470lm | EEK=F
6kWh/1000h

Art. Nr. 1005078

Variante	Art. Nr.
1xGU10	
■ schwarz	147550
1xGU10	
□ weiß	147551
1xGU10	
■ aluminium	147559

GU10 <50W

LED GU10 51mm | 4W | 36°
3000K | 280lm | EEK=F
4kWh/1000h

Art. Nr. 1004973

Variante	Art. Nr.
2xGU10	
■ schwarz	1002215
2xGU10	
□ weiß	151531
2xGU10	
■ grau / schwarz	151534



1002215 308



132020 308



147559 308

147414 311



ASTO TUBE

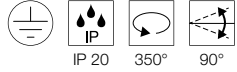

230V ~50Hz
Material: Aluminium



GU10 50W
Ø: 6,4 cm L: 8,1 cm



LED GU10 51mm | 4W | 36°
3000K | 280lm | EEK=F
4kWh/1000h



Art. Nr. 1004973



ASTO TUBE
CW, single, QPAR51

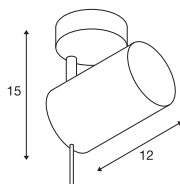

ASTO TUBE
CW, double, QPAR51

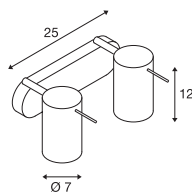
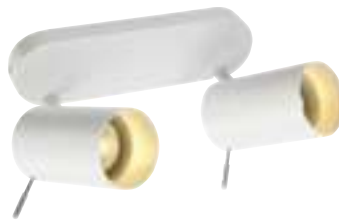

ASTO TUBE
CW, triple, QPAR51

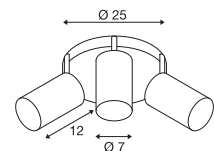

Variante	Art. Nr.
1xGU10	
<input type="checkbox"/> weiß	147411 ▼

Variante	Art. Nr.
2xGU10	
<input type="checkbox"/> weiß	147412 ▼

Variante	Art. Nr.
3xGU10	
<input type="checkbox"/> weiß	147414 ▼

PURI
CW, QPAR51

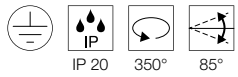

230V ~50Hz
Material: Aluminium / Stahl

• Dekoring inkl.



GU10 <50W



LED GU10 51mm | 4W | 36°
2700K | 270lm | EEC=G
4kWh/1000h



Art. Nr. 1004972

PURI
CW, single, QPAR51

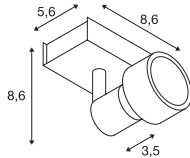

PURI
CW, double, QPAR51

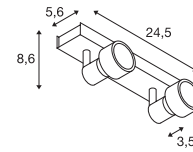

Variante	Art. Nr.
1xGU10	
■ schwarz	147360
1xGU10	
□ weiß	147361

Variante	Art. Nr.
2xGU10	
■ schwarz	147370
2xGU10	
□ weiß	147371



PURI
CW, triple, QPAR51

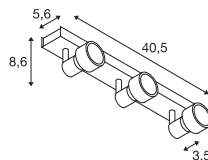

PURI
CW, quad, QPAR51

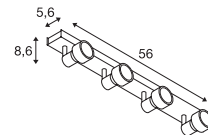

Variante	Art. Nr.
3xGU10	
■ schwarz	147380
3xGU10	
□ weiß	147381

Variante	Art. Nr.
4xGU10	
■ schwarz	1002029
4xGU10	
□ weiß	1002030



1002030 312





1000892 315



1000887 315

AVO
CW, QPAR51

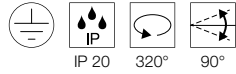

230V ~50Hz
Material: Stahl



GU10 <math><50\text{ W}</math>



LED GU10 51mm | 4W | 36°
2700K | 270lm | EEK=G
4kWh/1000h



Art. Nr. 1004972

AVO
CW, single, QPAR51

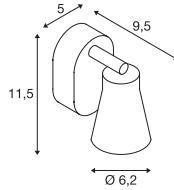

AVO
CW, double, QPAR51

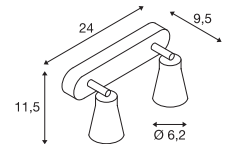

Variante	Art. Nr.
1xGU10	
■ schwarz	1000886
1xGU10	
□ weiß	1000887

Variante	Art. Nr.
2xGU10	
■ schwarz	1000889
2xGU10	
□ weiß	1000890

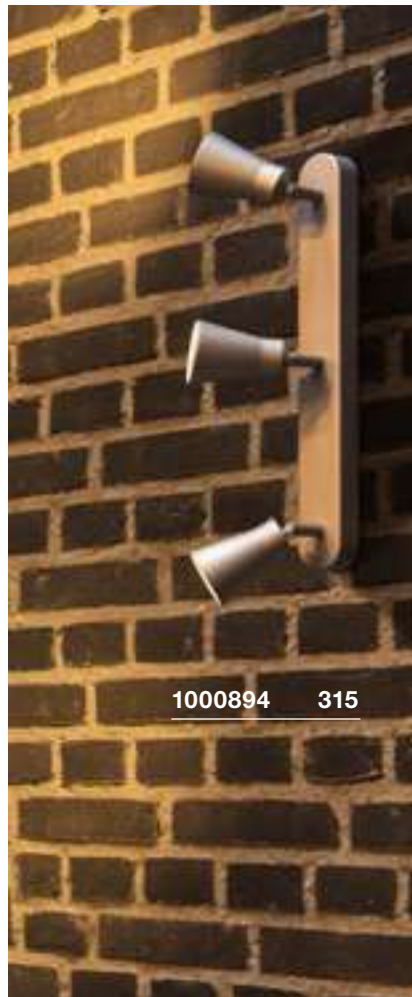

1000894 315

AVO
CW, triple, QPAR51

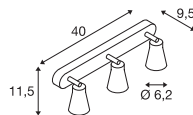

AVO
CW, quad, QPAR51

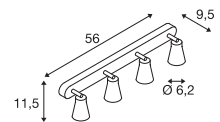



Variante	Art. Nr.
3xGU10	
■ schwarz	1000892
3xGU10	
□ weiß	1000893

Variante	Art. Nr.
4xGU10	
■ schwarz	1000895
4xGU10	
□ weiß	1000896

ASTO
CW, QPAR51



SOCKET INSIDE              <75 W

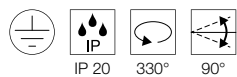

220-240V ~50/60Hz
Material: Aluminium

• Dekoring inkl.



GU10 <75W



LED GU10 51mm | 4W | 36°
3000K | 280lm | EEF=F
4kWh/1000h



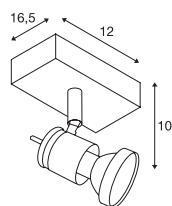

Art. Nr. 1004973

ASTO
CW, single, QPAR51

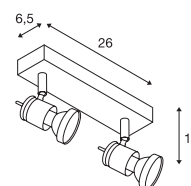

ASTO
CW, double, QPAR51



Variante	Art. Nr.
1xGU10	
 gebürstet aluminium	147441

Variante	Art. Nr.
2xGU10	
 gebürstet aluminium	147442

ASTO
CW, triple, QPAR51

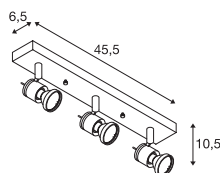

ASTO
CW, quad, QPAR51

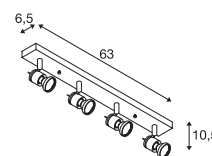

Variante	Art. Nr.
3xGU10	
 gebürstet aluminium	147443

Variante	Art. Nr.
4xGU10	
 gebürstet aluminium	147444





147443 316



FITU
CW, E27

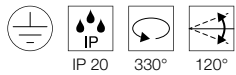
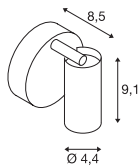

220-240V ~50/60Hz
Material: Aluminium / Stahl



E27 <60W



LED E27 | 7,5W | 320°
2500K | 700lm | EEC=F
8kWh/1000h



Art. Nr. 1005265

Variante	Art. Nr.
1xE27	
■ schwarz	1002585
1xE27	
□ weiß	1002584 ▼



1002584 318



1004705 319

SENSER 12
CW, quadratisch, PHASE

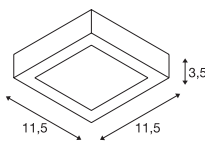
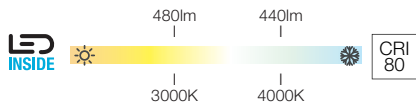

220-240V ~50/60Hz | 200mA
Systemleistung: 8,2W
Material: Aluminium

SENSER 18
CW, quadratisch, PHASE

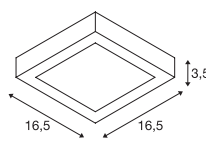
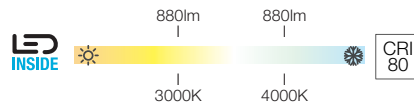

220-240V ~50/60Hz | 350mA
Systemleistung: 12W
Material: Aluminium

SENSER 24
CW, quadratisch, PHASE

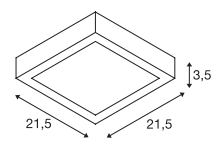
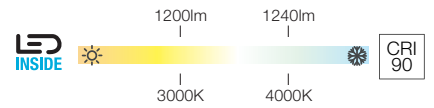

220-240V ~50/60Hz | 500mA
Systemleistung: 15W
Material: Aluminium

1003017, 1004703	480lm 440lm 3000K 4000K	

Variante	Art. Nr.
480lm 3000K CRI80 <input type="checkbox"/> weiß	1003017
440lm 4000K CRI80 <input type="checkbox"/> weiß	1004703

1003018, 1004704	880lm 880lm 3000K 4000K	

Variante	Art. Nr.
880lm 3000K CRI80 <input type="checkbox"/> weiß	1003018
880lm 4000K CRI90 <input type="checkbox"/> weiß	1004704

1003019, 1004705	1200lm 1240lm 3000K 4000K	

Variante	Art. Nr.
1200lm 3000K CRI90 <input type="checkbox"/> weiß	1003019
1240lm 4000K CRI90 <input type="checkbox"/> weiß	1004705

SENSER 12
CW, rund, PHASE



SENSER 18
CW, rund, PHASE



SENSER 24
CW, rund, PHASE

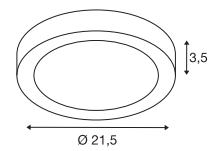
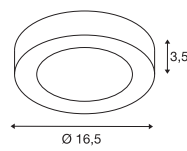
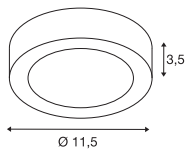
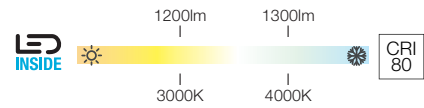
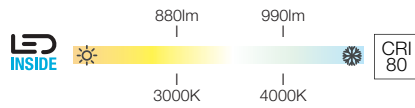
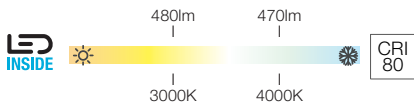

IP 20 IK02 L70B50

IP 20 IK02 L70B50

IP 20 IK02 L70B50

220-240V ~50/60Hz | 200mA
Systemleistung: 8,2W
Material: Aluminium

220-240V ~50/60Hz | 350mA
Systemleistung: 12W
Material: Aluminium

220-240V ~50/60Hz | 500mA
Systemleistung: 15W
Material: Aluminium

1003014, 1004700	480lm 470lm 3000K 4000K	

1003015, 1004701	880lm 990lm 3000K 4000K	

1003016, 1004702	1200lm 1300lm 3000K 4000K	

Variante	Art. Nr.
480lm 3000K CRI80 <input type="checkbox"/> weiß	1003014
470lm 4000K CRI90 <input type="checkbox"/> weiß	1004700

Variante	Art. Nr.
880lm 3000K CRI80 <input type="checkbox"/> weiß	1003015
990lm 4000K CRI90 <input type="checkbox"/> weiß	1004701

Variante	Art. Nr.
1200lm 3000K CRI80 <input type="checkbox"/> weiß	1003016
1300lm 4000K CRI90 <input type="checkbox"/> weiß	1004702



1004700/01/02 320

SIMA
CW, rund, Sensor



SIMA
CW, rund, PHASE

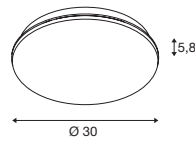
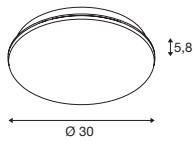
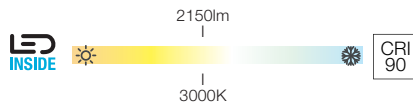
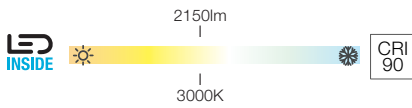

220-240V ~50/60Hz | 350mA
Systemleistung: 24W
Material: Polycarbonat (PC)

220-240V ~50/60Hz | 350mA
Systemleistung: 24W
Material: Polycarbonat (PC)

1005086	2150lm 3000K	

1005085	2150lm 3000K	

Variante	Art. Nr.
2150lm 3000K CRI90 <input type="checkbox"/> weiß	1005086

Variante	Art. Nr.
2150lm 3000K CRI90 <input type="checkbox"/> weiß	1005085





1005088 323

SIMA
CW, quadratisch, Sensor

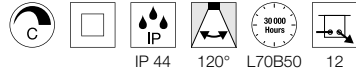
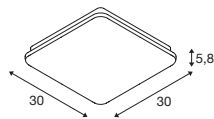
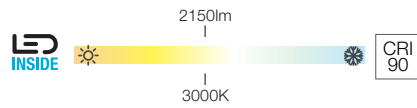

220-240V ~50/60Hz | 350mA
Systemleistung: 24W
Material: Polycarbonat (PC)

SIMA
CW, quadratisch, PHASE

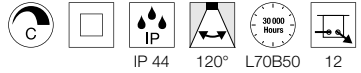
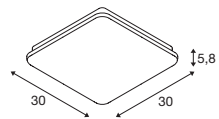
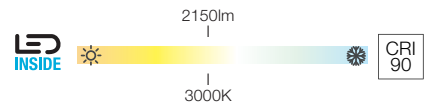

220-240V ~50/60Hz | 350mA
Systemleistung: 24W
Material: Polycarbonat (PC)



1005088	2150lm 3000K	

Variante	Art. Nr.
2150lm 3000K CRI90	
<input type="checkbox"/> weiß	1005088





1005087	2150lm 3000K	

Variante	Art. Nr.
2150lm 3000K CRI90	
<input type="checkbox"/> weiß	1005087

LIPSY® LEUCHTENFAMILIE.

FARBE NACH IHREM WUNSCH.

	LIPSY® 30 Dome	LIPSY® 40 Dome	LIPSY® 50 Dome	
Beispiel				
Leuchtmittel				
Sensor	-	-	-	
Größe	Ø: 30 cm	Ø: 35 cm	Ø: 40 cm	
Farbtemperatur	3000K 4000K	3000K 4000K	3000K 4000K	 Bei dieser LIPSY® Variante können Sie die Farbtemperatur wählen/schalten!
Lichtfarbe	1400/1600lm	1800/2000lm	2200/2400lm	
Steuerung Dimmbar	-	-	-	

	LIPSY® 40 CW, Drum, DALI	LIPSY® 50 CW, Drum, DALI	
Beispiel			
Leuchtmittel			
Sensor	-	-	
Größe	Ø: 35 cm	Ø: 40 cm	
Farbtemperatur	3000K 4000K	3000K 4000K	 Bei dieser LIPSY® Variante können Sie die Farbtemperatur wählen!
Lichtfarbe	1800/2000lm	2200/2400lm	
Steuerung Dimmbar			



	LIPSY® 30 Drum	LIPSY® 40 Drum	LIPSY® 50 Drum	
Beispiel				  Bei dieser LIPSY® Variante können Sie die Farbtemperatur wählen/schalten!
Leuchtmittel				
Sensor	–	–	–	
Größe	Ø: 30 cm	Ø: 35 cm	Ø: 40 cm	
Farbtemperatur	3000K 4000K	3000K 4000K	3000K 4000K	
Lichtfarbe	1400/1600lm	1800/2000lm	2200/2400lm	
Steuerung Dimmbar	–	–	–	

LIPSY® 30
CW, Dome

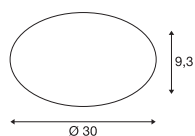
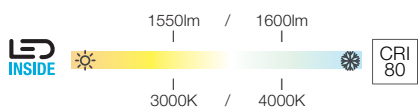

IP 44 110° L70B50

220-240V ~50/60Hz | 350mA
Systemleistung: 13,5W
Material: Aluminium / Polycarbonat (PC)

LIPSY® 40
CW, Dome

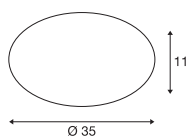
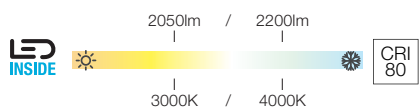

IP 44 110° L70B50

220-240V ~50/60Hz | 500mA
Systemleistung: 17,5W
Material: Aluminium / Polycarbonat (PC)

LIPSY® 50
CW, Dome

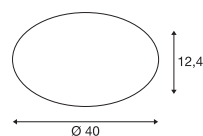
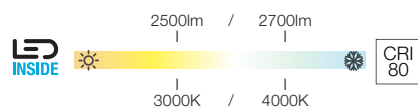

IP 44 110° L70B50

220-240V ~50/60Hz | 500mA
Systemleistung: 20W
Material: Aluminium / Polycarbonat (PC)

1002020	1550/1600lm 3000/4000K	

Variante **Art. Nr.**
1550/1600lm | 3000/4000K | CRI80
 weiß **1002020**

1002021	2050/2200lm 3000/4000K	

Variante **Art. Nr.**
2050/2200lm | 3000/4000K | CRI80
 weiß **1002021**

1002022	2500/2700lm 3000/4000K	

Variante **Art. Nr.**
2500/2700lm | 3000/4000K | CRI80
 weiß **1002022**



1002022 326

1002076 329



LIPSY® 30
CW, Drum

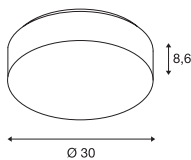
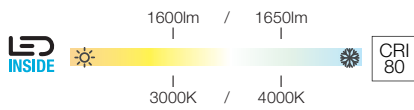

220-240V ~50/60Hz | 350mA
Systemleistung: 13,5W
Material: Aluminium / Polycarbonat (PC)

LIPSY® 40
CW, Drum

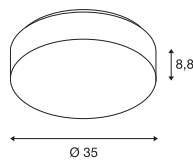

220-240V ~50/60Hz | 500mA
Systemleistung: 17,5W
Material: Aluminium / Polycarbonat (PC)

LIPSY® 50
CW, Drum

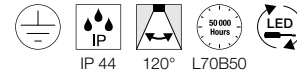
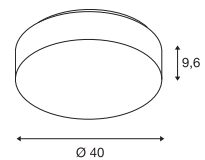
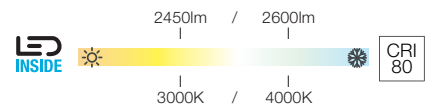

220-240V ~50/60Hz | 500mA
Systemleistung: 20W
Material: Aluminium / Polycarbonat (PC)



1002075	1600/1650lm 3000/4000K	

Variante Art. Nr.
1600/1650lm | 3000/4000K | CRI80
□ weiß **1002075**



1002076	2100/2300lm 3000/4000K	

Variante Art. Nr.
2100/2300lm | 3000/4000K | CRI80
□ weiß **1002076**



1002077	2450/2600lm 3000/4000K	

Variante Art. Nr.
2450/2600lm | 3000/4000K | CRI80
□ weiß **1002077**

LIPSY® 40
CW, Drum, DALI

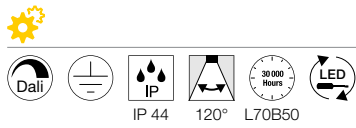
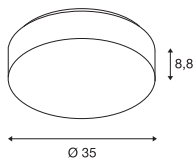
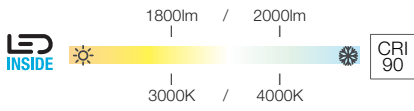

220-240V ~50/60Hz | 500mA
Systemleistung: 18W
Material: Aluminium / Polycarbonat (PC)

LIPSY® 50
CW, Drum, DALI

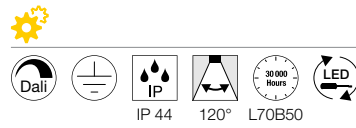
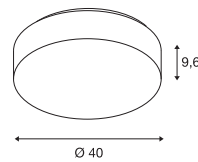
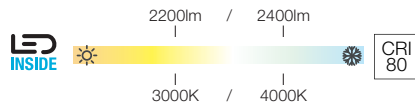

220-240V ~50/60Hz | 500mA
Systemleistung: 21W
Material: Aluminium / Polycarbonat (PC)

1002940	1800/2000lm 3000/4000K	

1002941	2200/2400lm 3000/4000K	

Variante **Art. Nr.**
1800/2000lm | 3000/4000K | CRI90
□ weiß **1002940**

Variante **Art. Nr.**
2200/2400lm | 3000/4000K | CRI80
□ weiß **1002941**

1002940 330



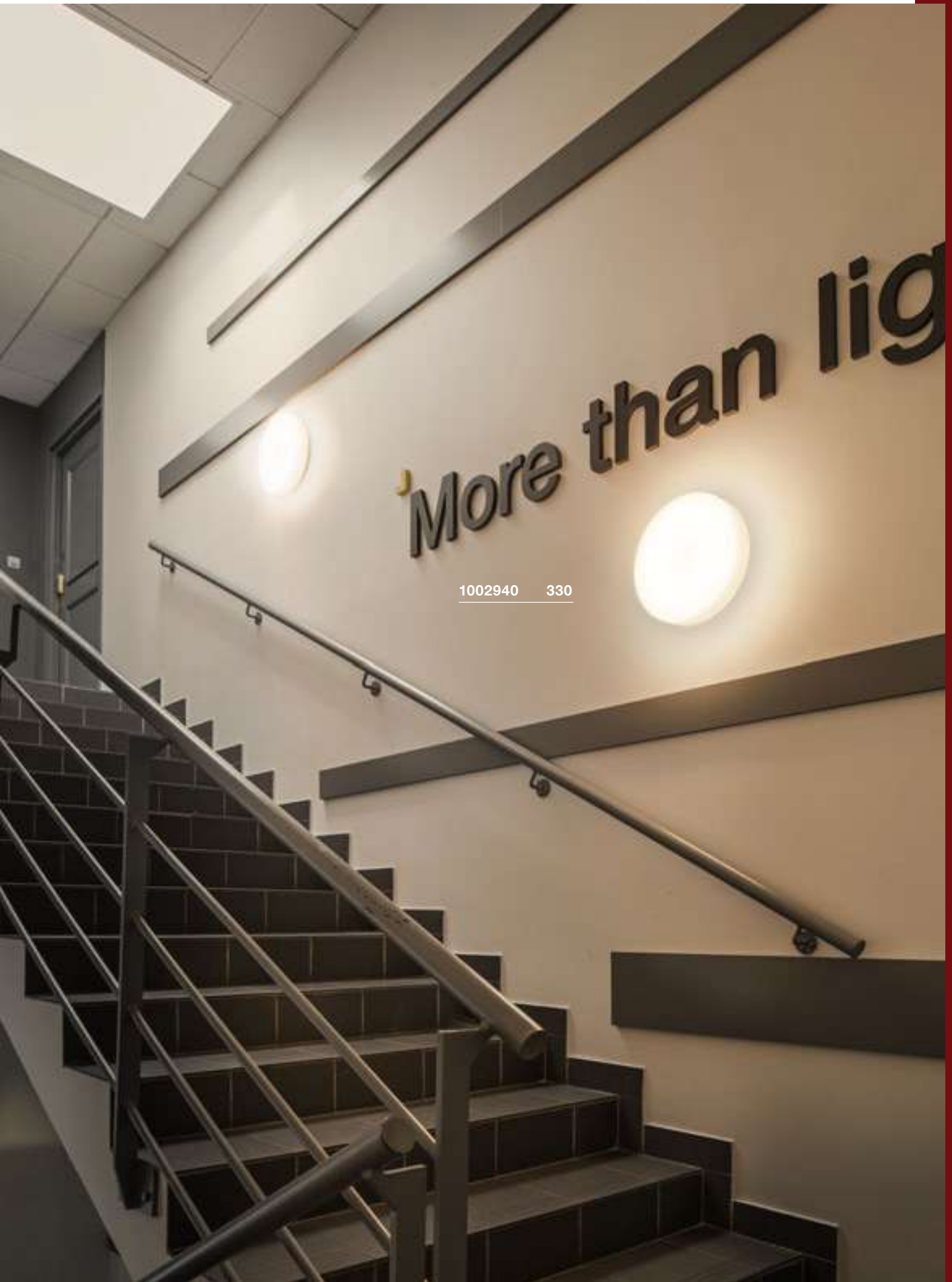

More than lig

1002940 330

MELAN
CW, E27

GLASSA
CW, quadratisch, E27

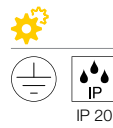
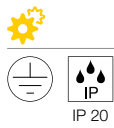
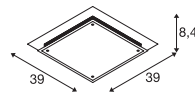
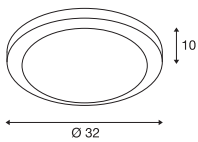
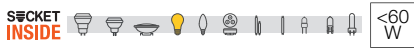

230V ~50Hz
Material: Aluminium / Glas

220-240V ~50/60Hz
Material: Stahl / Glas

E27 <60W
Ø: 7 cm L: 16 cm

E27 <60W
Ø: 4,8 cm L: 14,8 cm

LED E27 | 13,2W | 220°
2700K | 1300lm | EEK=F
13kWh/1000h

LED E27 | 8W | 240°
3000K | 880lm | EEK=E
8kWh/1000h

Art. Nr. 1005302

Art. Nr. 1005289

Variante	Art. Nr.
1xE27	
aluminium	155236

Variante	Art. Nr.
2xE27	
silber	155180



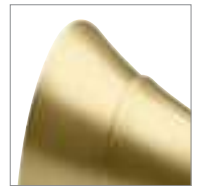
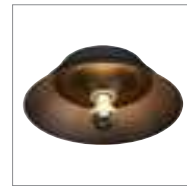

1000746 333

BATO 35
CW, E27

SOCKET INSIDE                <60 W

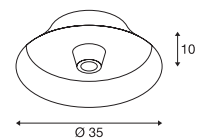

IP 20

220-240V ~50/60Hz
Material: Aluminium / Stahl



E27 <60W



LED E27 | 7,5W | 180°
2700K | 720lm | EEK=F
8kWh/1000h



Art. Nr. 1005305

Variante	Art. Nr.
1xE27	
■ schwarz	1000746
1xE27	
■ messing	1000748

BATTEN 60
CW

NEW

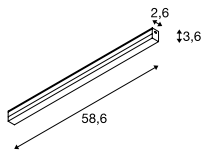
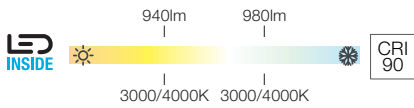
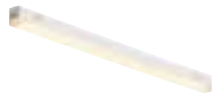

220-240V ~50/60Hz | 110mA
Systemleistung: 9W
Material: Polycarbonat (PC)

BATTEN 120
CW

NEW

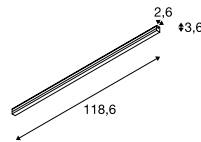
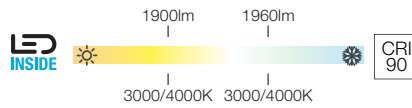

220-240V ~50/60Hz | 220mA
Systemleistung: 18W
Material: Polycarbonat (PC)

1006123	940/980lm 3000/4000K	

Variante **Art. Nr.**
940/980lm | 3000/4000K | CRI90
 weiß **1006123**

1006124	1900/1960lm 3000/4000K	

Variante **Art. Nr.**
1900/1960lm | 3000/4000K | CRI90
 weiß **1006124**

Einspeisekabel

Polyvinylchlorid (PVC)
150 cm Kabellänge



Variante **Art. Nr.**
 weiß **1006125**

Montageclips

Polyvinylchlorid (PVC)



Variante **Art. Nr.**
 weiß **1006126**

Kabelverbinder

Polyvinylchlorid (PVC)
60 cm Kabellänge



Variante **Art. Nr.**
 weiß **1006127**

Direktverbinder

Polyvinylchlorid (PVC)
60 cm Kabellänge



Variante **Art. Nr.**
 weiß **1006128**



1006124 334

LONG GRILL
CW



1001020 336

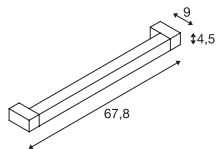
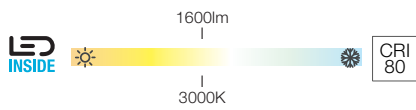

220-240V ~50/60Hz | 700mA
 Systemleistung: 20W
 Material: Aluminium / Acryl



1001020, 1001019	1600lm 3000K	

Variante	Art. Nr.
1600lm 3000K CRI80 ■ schwarz	1001020
1600lm 3000K CRI80 □ weiß	1001019



1001286 337

SIGHT 60
CW

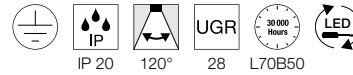
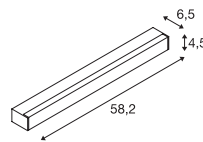
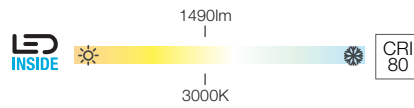
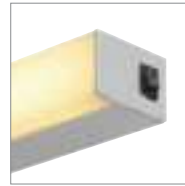

220-240V ~50/60Hz | 700mA
Systemleistung: 20W
Material: Aluminium / Acryl

SIGHT 115
CW

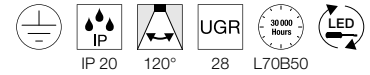
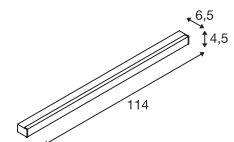
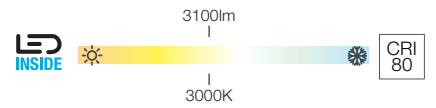
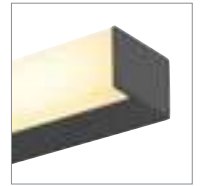
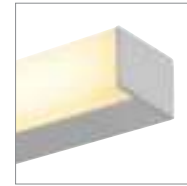
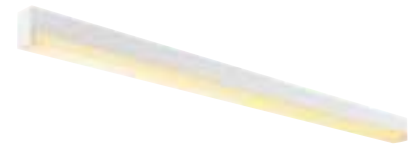

220-240V ~50/60Hz | 700mA
Systemleistung: 38W
Material: Aluminium / Acryl



1001283, 1001284, 1001285	1490lm 3000K	A → G E

Variante	Art. Nr.
1490lm 3000K CRI80	
■ schwarz	1001283
1490lm 3000K CRI80	
□ weiß	1001284
1490lm 3000K CRI80	
■ grau	1001285



1001286, 1001287, 1001288	3100lm 3000K	A → G E

Variante	Art. Nr.
3100lm 3000K CRI80	
■ schwarz	1001286
3100lm 3000K CRI80	
□ weiß	1001287
3100lm 3000K CRI80	
■ grau	1001288



BENA Video



bit.ly/slv-bena





631337 339



631339 339

BENA 120
CW

BENA 150
CW

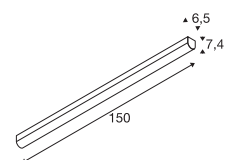
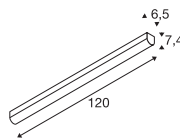
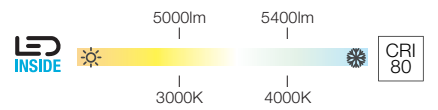
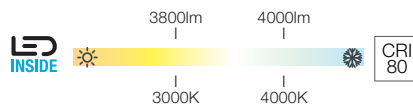

220-240V ~50/60Hz | 700mA
Systemleistung: 28W
Material: Polymethylacrylat (PMMA) / Stahl



220-240V ~50/60Hz | 700mA
Systemleistung: 36W
Material: Polymethylacrylat (PMMA) / Stahl



631337, 631347	3800lm 4000lm 3000K 4000K	



631339, 631349	5000lm 5400lm 3000K 4000K	

Variante	Art. Nr.
3800lm 3000K CRI80 <input type="checkbox"/> weiß	631337
4000lm 4000K CRI80 <input type="checkbox"/> weiß	631347

Variante	Art. Nr.
5000lm 3000K CRI80 <input type="checkbox"/> weiß	631339
5400lm 4000K CRI80 <input type="checkbox"/> weiß	631349

P-LIGHT
CW



P-LIGHT
CW

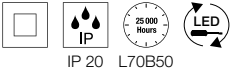
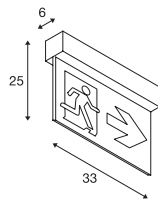
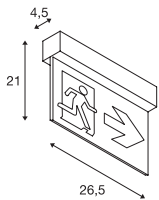

220-240V ~50Hz
Systemleistung: 3,5W
Material: ABS / Polycarbonat (PC)

220-240V ~50/60Hz
Systemleistung: 4W
Material: ABS / Polycarbonat (PC)

- Erkennungsweite 24 m. 3 Rettungswegzeichen (rechts/links/runter) und 1 weiße Folie beigelegt. Notbeleuchtung mit eingebautem Ni-Mh Akku. mit automatischem Selbsttest. Notbetriebszeit 3 Std. Leuchtdichte >15cd/ m². Betriebsart: Dauerschaltung/Bereitschaft

- Erkennungsweite 30 m. 3 Rettungswegzeichen (rechts/links/runter) und 1 weiße Folie beigelegt. Notbeleuchtung mit eingebautem Ni-Mh Akku. mit automatischem Selbsttest. Notbetriebszeit 3 Std. Leuchtdichte >15cd/ m². Betriebsart: Dauerschaltung/Bereitschaft



Piktogrammfolie
Art. Nr. 240007
Akkumulator
Art. Nr. 240020



Piktogrammfolie
Art. Nr. 240008
Akkumulator
Art. Nr. 240021



Variante	Art. Nr.
32lm 6000K CRI80	
□ weiß	240000

Variante	Art. Nr.
32lm 6000K CRI70	
□ weiß	240002





240004 341

P-LIGHT
CW

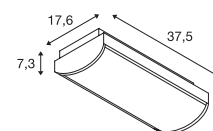

IP 65 110° L70B50

220-240V ~50Hz
Systemleistung: 6,5W
Material: Polycarbonat (PC)

- Erkennungsweite 30 m. Verwendung als Notbeleuchtung. Auto Test Funktion. Ni-Mh Akku 2x 3.6V 1.0Ah inklusiv. Notbetrieb über Akku 2 Std. Rettungswegzeichen optional erhältlich und als Nothinweisleuchte verwendbar.

Piktogrammfolien

Material: Polypropylen (PP)
B: 24 cm H: 13,1 cm



4-teiliges Piktogrammset zum Einlegen

Variante	Art. Nr.
■ grün	240007

Piktogrammfolien

Material: Polypropylen (PP)
B: 35,3 cm H: 16,5 cm



3-teiliges Piktogrammset zum Einlegen (oben, unten, rechts)

Variante	Art. Nr.
■ grün	240009

Piktogrammfolien

Material: Polypropylen (PP)
B: 30 cm H: 16,1 cm



3-teiliges Piktogrammset zum Einlegen

Variante	Art. Nr.
■ grün	240008

Piktogrammfolien

Material: Polypropylen (PP)
B: 35,3 cm H: 16,5 cm



2-teiliges Piktogrammset zum Einlegen (rechts schräg hoch/ rechts schräg runter)

Variante	Art. Nr.
■ grün	240010



- Piktogrammfolie Art. Nr. 240009
- Piktogrammfolie Art. Nr. 240010
- Akkumulator Art. Nr. 240022

Variante	Art. Nr.
100lm 6000K CRI70	
□ weiß	240004

TIEF VERWURZELT.

EINBAULEUCHTEN BEEINDRUCKEN MIT STRAHLKRAFT.

Ob gerichtet oder breitstrahlend, statisch oder schwenkbar: Einbauleuchten sind das Kernelement vieler Beleuchtungskonzepte und eine gute Alternative zu freihängenden Leuchten. Denn: Sie passen sich jedem Ambiente an und gewähren dabei viel Einrichtungsspielraum.





1001015 406

UNSER QUALITÄTSVERSPRECHEN

INNOVATION UND ENTWICKLUNG

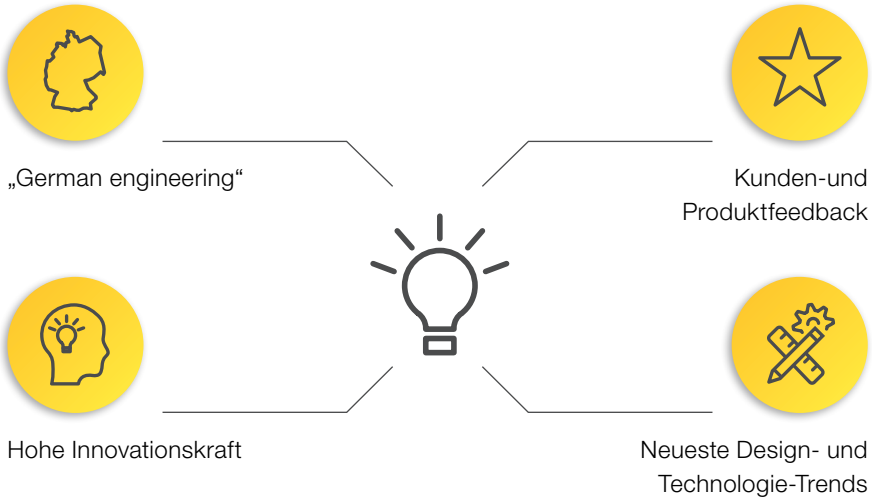

HERSTELLUNG

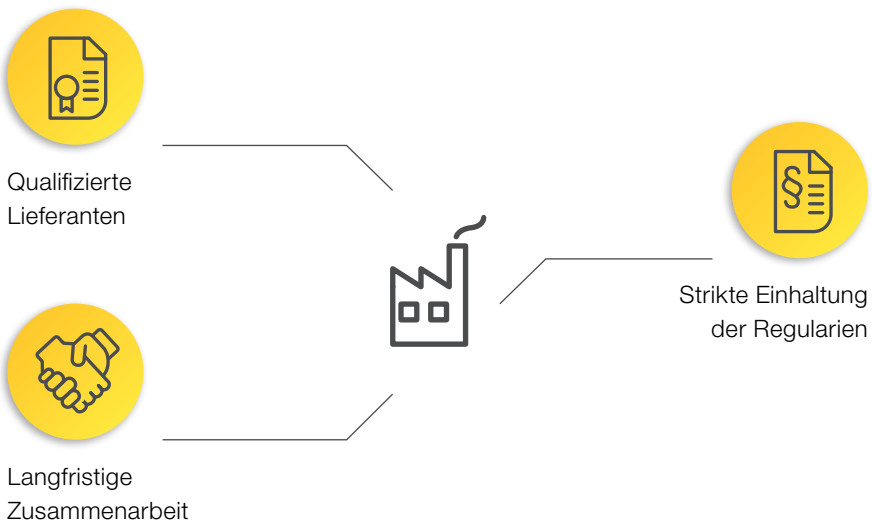

QUALITÄTSSICHERUNG

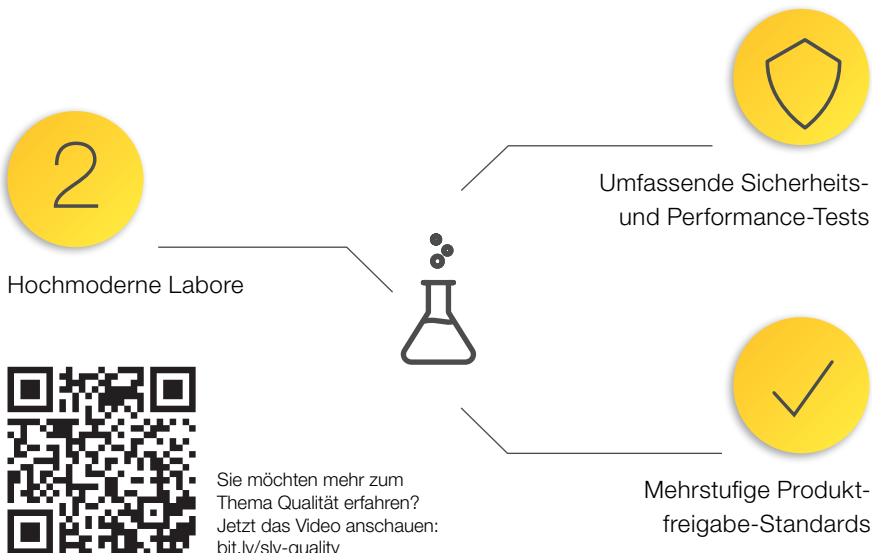

Sie möchten mehr zum Thema Qualität erfahren? Jetzt das Video anschauen: bit.ly/slv-quality





EINBAULEUCHTEN

NEW		NEW		NEW					
349	349	349	350	350	351	351	351	352	352
352	352	353	354	355	355	355	355	356	
356	357	357	358	358	359	359	359	360	360
361	361	361	362	362	362	363	363	364	364
365	366	366	366	367	368	368	368	369	369
369	370	370	371	371	371	372	372	373	373
374	375	376	376	376	378	378	378	379	379
379	379	380	380	382	383	384	384	384	384
384	385	386	386	387	387	389	389	389	389
389	390	390	390	393	393	393	394	394	394
394	395	395	396	397	397	398	398	398	398

NEW VARIANT

Einbauleuchten aus dem NUMINOS® Down- und Spotlightsystem finden Sie auf den Seiten 28 bis 57. Oder ganz einfach online konfigurieren unter: www.numinos.slv.com



1003809 31

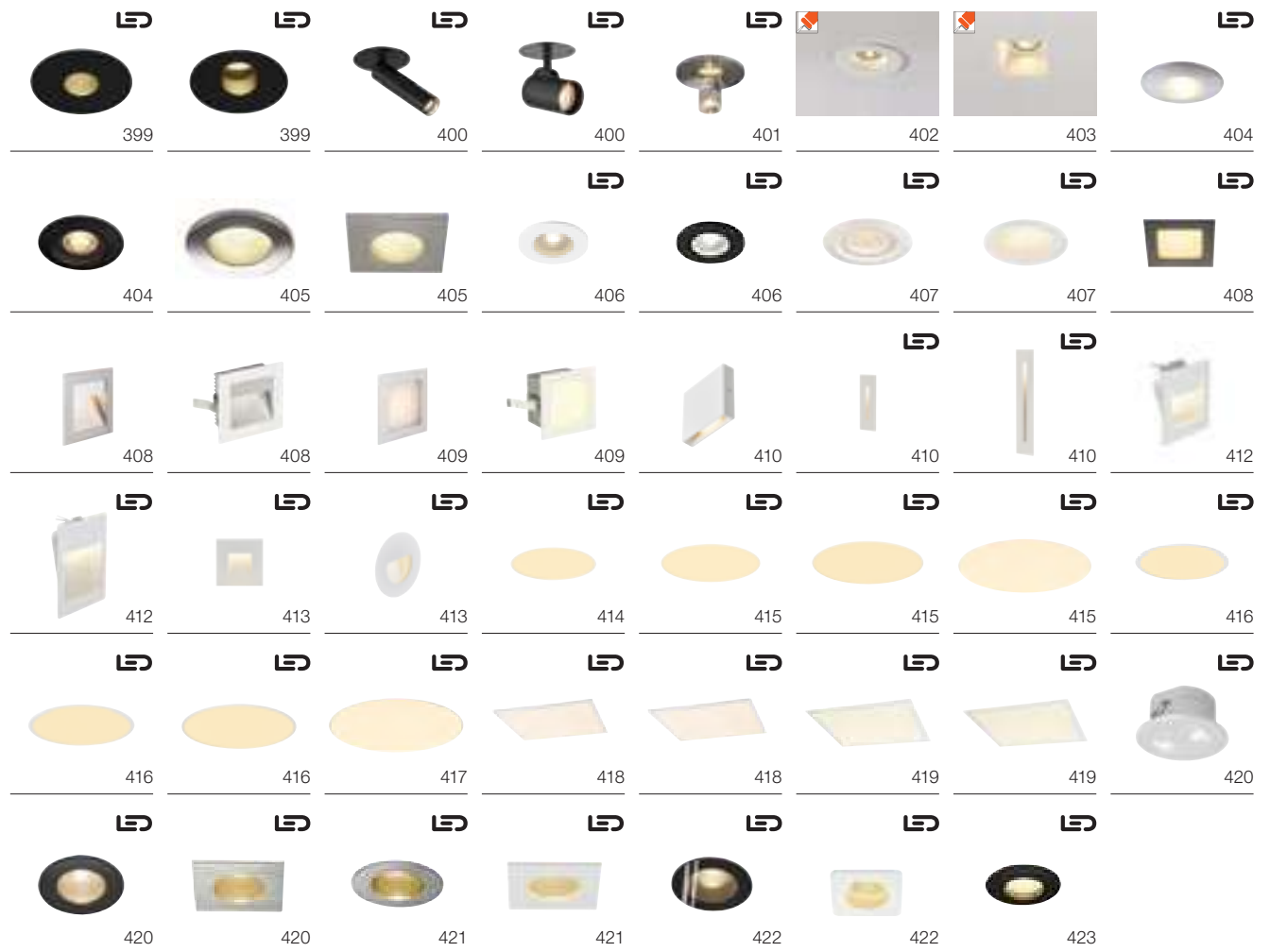

Weitere Leuchten und Varianten finden Sie online unter www.slv.com
 Herstellerangaben unserer Leuchtmittelempfehlungen finden Sie Im Kapitel Leuchtmittel ab Seite 808



1005407 349



MILANDOS 4
DL

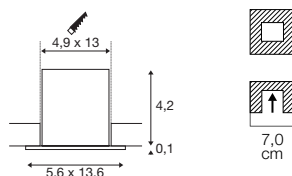
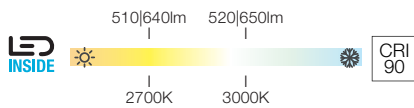
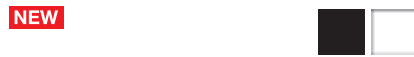

700mA
Leistungsaufnahme: 8W
Material: Aluminium / Polycarbonat (PC)

1005407, 1005409	510lm 640lm 2700K	
1005408, 1005410	520lm 650lm 3000K	

- +**
- LED Treiber 700mA | 10,5W dimmbar inkl. Zugentlastung
Art. Nr. 464142
 - LED Treiber 20W | 250-700 mA | 1-10V/DALI dimmbar | inkl. Zugentlastung
Art. Nr. 1002423

Variante	Art. Nr.
510lm 2700K CRI90 UGR16	
■ schwarz	1005407
640lm 2700K CRI90 UGR23	
□ weiß	1005409
520lm 3000K CRI90 UGR16	
■ schwarz	1005408
650lm 3000K CRI90 UGR23	
□ weiß	1005410

MILANDOS 6
DL

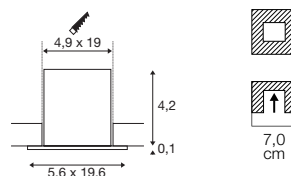
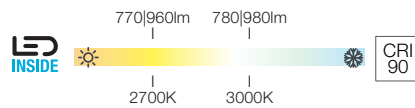

700mA
Leistungsaufnahme: 12W
Material: Aluminium / Polycarbonat (PC)

1005415, 1005417	770lm 960lm 2700K	
1005416, 1005418	780lm 980lm 3000K	

- +**
- LED Treiber 15W | 700mA | inkl. Zugentlastung
Art. Nr. 464147
 - LED Treiber 20W | 250-700 mA | 1-10V/DALI dimmbar | inkl. Zugentlastung
Art. Nr. 1002423

Variante	Art. Nr.
770lm 2700K CRI90 UGR16	
■ schwarz	1005415
960lm 2700K CRI90 UGR23	
□ weiß	1005417
780lm 3000K CRI90 UGR16	
■ schwarz	1005416
980lm 3000K CRI90 UGR23	
□ weiß	1005418

MILANDOS 8
DL

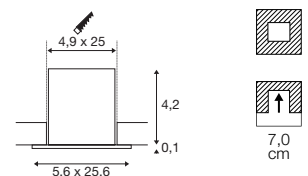
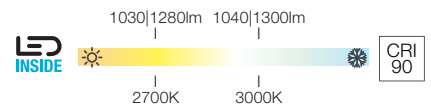

700mA
Leistungsaufnahme: 16W
Material: Aluminium / Polycarbonat (PC)

1005423, 1005425	1030lm 1280lm 2700K	
1005424, 1005426	1040lm 1300lm 3000K	

- +**
- LED Treiber 20W | 250-700 mA | 1-10V/DALI dimmbar | inkl. Zugentlastung
Art. Nr. 1002423
 - LED Treiber 20W | 700mA | dimmbar | inkl. Zugentlastung
Art. Nr. 1006202

Variante	Art. Nr.
1030lm 2700K CRI90 UGR16	
■ schwarz	1005423
1280lm 2700K CRI90 UGR23	
□ weiß	1005425
1040lm 3000K CRI90 UGR16	
■ schwarz	1005424
1300lm 3000K CRI90 UGR23	
□ weiß	1005426

NEW TRIA 68
DL, rund, QPAR51

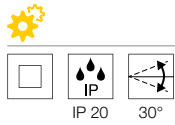
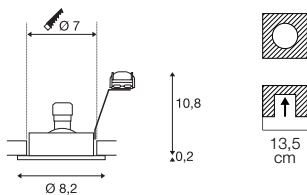

230V ~50Hz
Material: Aluminium

- Produkte werden mit Clipfedern geliefert. Blattfedern liegen dem Produkt bei und können ausgetauscht werden.
- Materialstarke Einbaufäche: 20 mm

NEW TRIA 68
DL, eckig, QPAR51

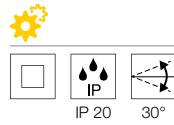
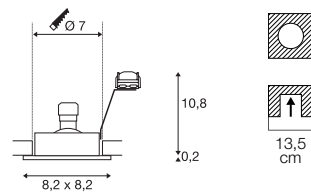

230V ~50Hz
Material: Aluminium

- Produkte werden mit Clipfedern geliefert. Blattfedern liegen dem Produkt bei und können ausgetauscht werden.
- Materialstarke Einbaufäche: 20 mm

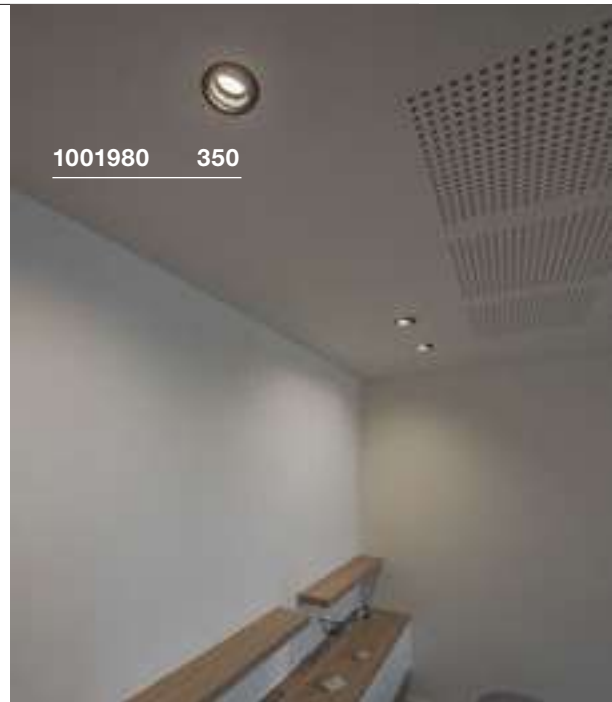

1001980 350

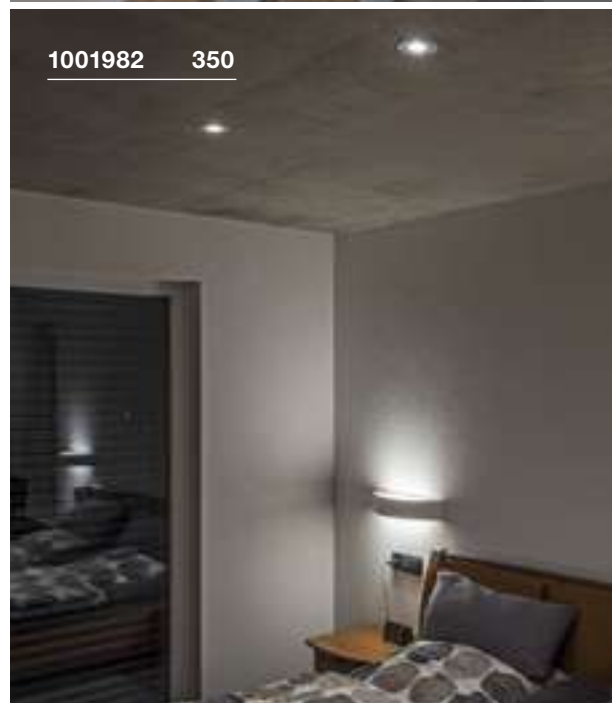

1001982 350

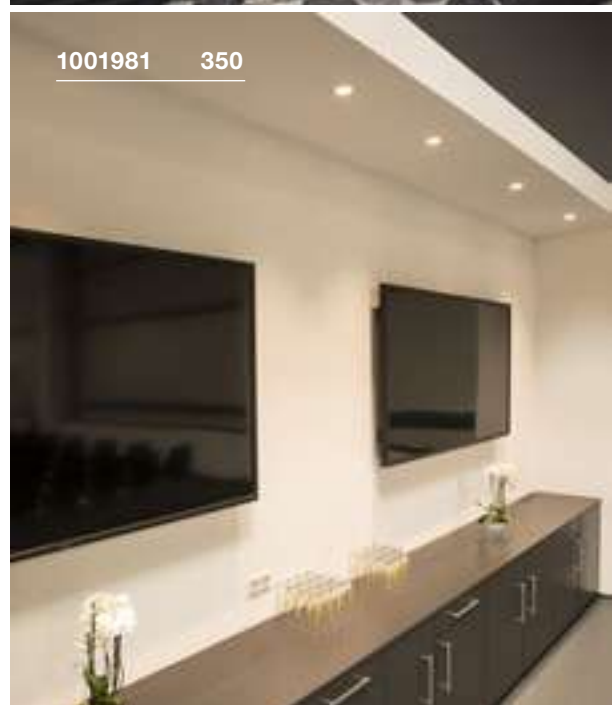

1001981 350

GU10 <50W

LED GU10 51mm | 4W | 36°
2700K | 270lm | EEK=G
4kWh/1000h
Art. Nr. 1004972

Variante	Art. Nr.
1xGU10	
■ schwarz	1001980
□ weiß	1001981
■ aluminium	1001982

GU10 <50W

LED GU10 51mm | 4W | 36°
3000K | 280lm | EEK=F
4kWh/1000h
Art. Nr. 1004973

Variante	Art. Nr.
1xGU10	
■ schwarz	1001994
□ weiß	1001995
■ aluminium	1001996



113456 351

NEW TRIA 78 XL
DL, rund, QPAR51



NEW TRIA 78 XL
DL, eckig, QPAR51

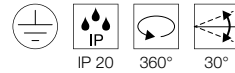
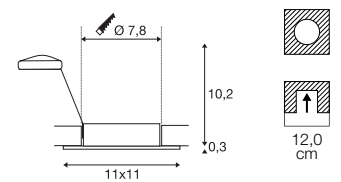
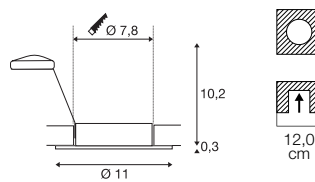

230V ~50Hz
Material: Aluminium

- Materialstarke Einbaufäche: 18 mm

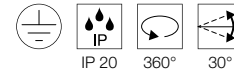

230V ~50Hz
Material: Aluminium

- Materialstarke Einbaufäche: 18 mm



113440 351



GU10 <50W



LED GU10 51mm | 4W | 36°
3000K | 280lm | EEK=F
4kWh/1000h

Art. Nr. 1004973



GU10 <50W



LED GU10 | 6W | 36°
2700K | 900lm | EEK=G
6kWh/1000h

Art. Nr. 1005273

Variante	Art. Nr.
1xGU10	
■ schwarz	113440
1xGU10	
□ weiß	113441
1xGU10	
□ aluminium	113446

Variante	Art. Nr.
1xGU10	
■ schwarz	113450
1xGU10	
□ weiß	113451
1xGU10	
□ aluminium	113456

NEW TRIA 78
DL, rund, QPAR51

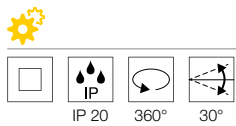
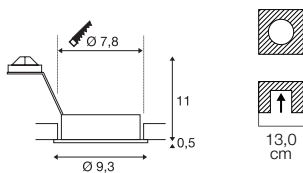

220-240V ~50/60Hz
Material: Aluminium

- Blattfedern
- Materialstärke Einbaufäche: 20 mm max

GU10 <50W

LED GU10 | 6W | 36°
2700K | 900lm | EEK=G
6kWh/1000h

Art. Nr. 1005273

Variante	Art. Nr.
1xGU10	
■ schwarz	111710
1xGU10	
□ weiß	111711
1xGU10	
■ aluminium	111716

NEW TRIA 78
DL, eckig, QPAR51

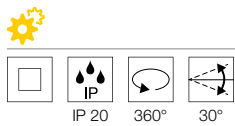
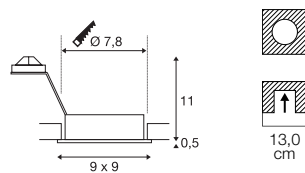
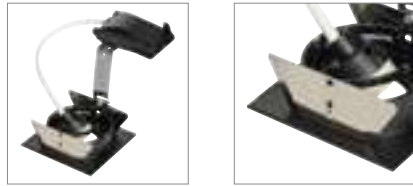

220-240V ~50/60Hz
Material: Aluminium

- Blattfedern
- Materialstärke Einbaufäche: 20 mm max

GU10 <50W

LED GU10 51mm | 4W | 36°
2700K | 270lm | EEK=G
4kWh/1000h

Art. Nr. 1004972

Variante	Art. Nr.
1xGU10	
■ schwarz	111720
1xGU10	
□ weiß	111721
1xGU10	
■ aluminium	111726

NEW TRIA 78
DL, rund, QPAR51

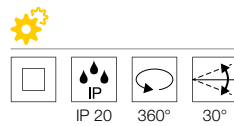
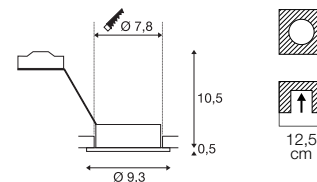

220-240V ~50/60Hz
Material: Aluminium

- Clipfedern
- Materialstärke Einbaufäche: 18 mm max

GU10 <50W

LED GU10 51mm | 4W | 36°
3000K | 280lm | EEK=F
4kWh/1000h

Art. Nr. 1004973

Variante	Art. Nr.
1xGU10	
■ schwarz	113490
1xGU10	
□ weiß	113510
1xGU10	
■ aluminium	111360

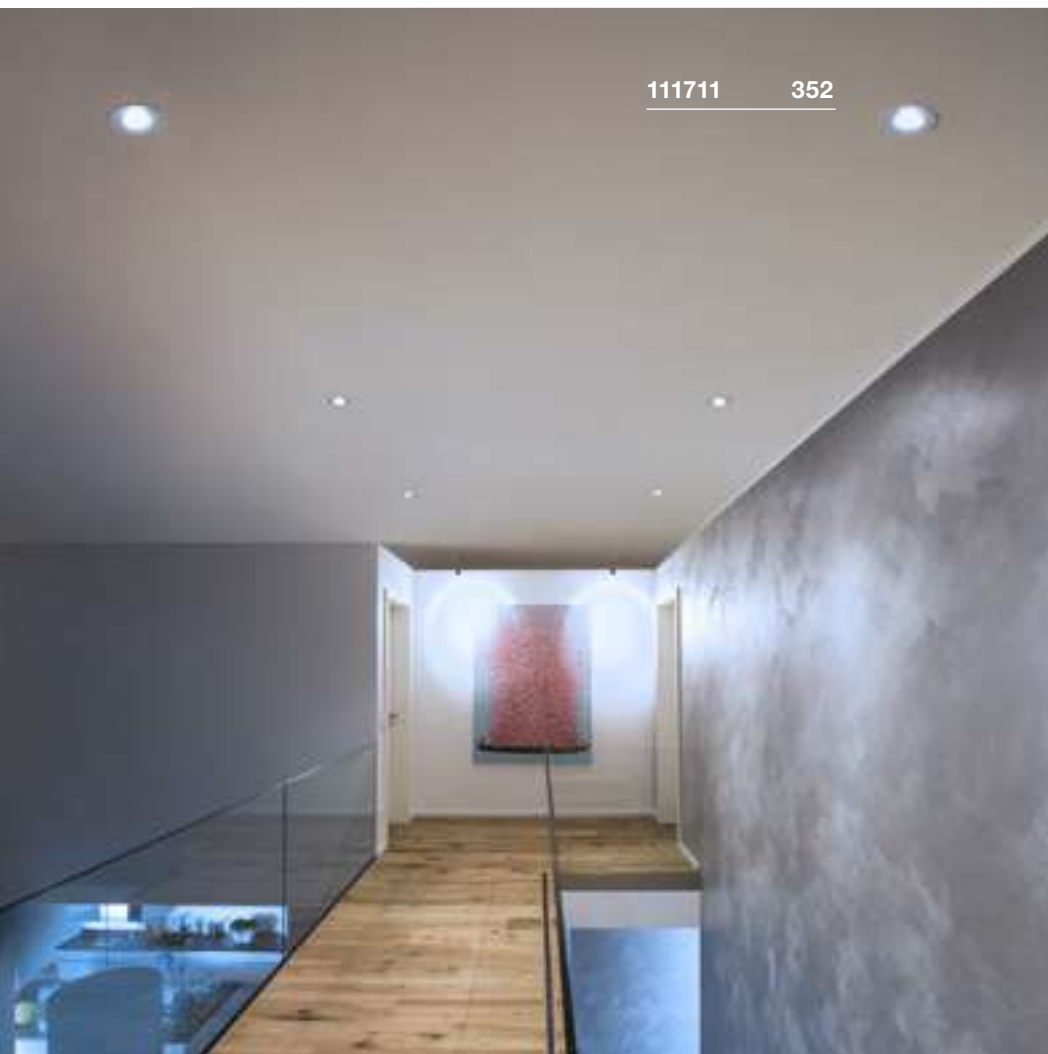

111711 352

NEW TRIA 78
DL, eckig, QPAR51

SOCKET INSIDE <50 W

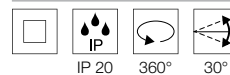
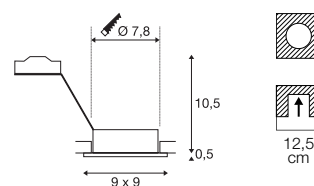

220-240V ~50/60Hz
Material: Aluminium

- Clipfedern
- Materialstärke Einbaufäche: 18 mm max



GU10 <50W



LED GU10 | 6W | 10°
3000K | 450lm | EEK=G
6kWh/1000h



Art. Nr. 1005278

Variante	Art. Nr.
1xGU10	
■ schwarz	113491
□ weiß	113511
1xGU10	
□ aluminium	111361

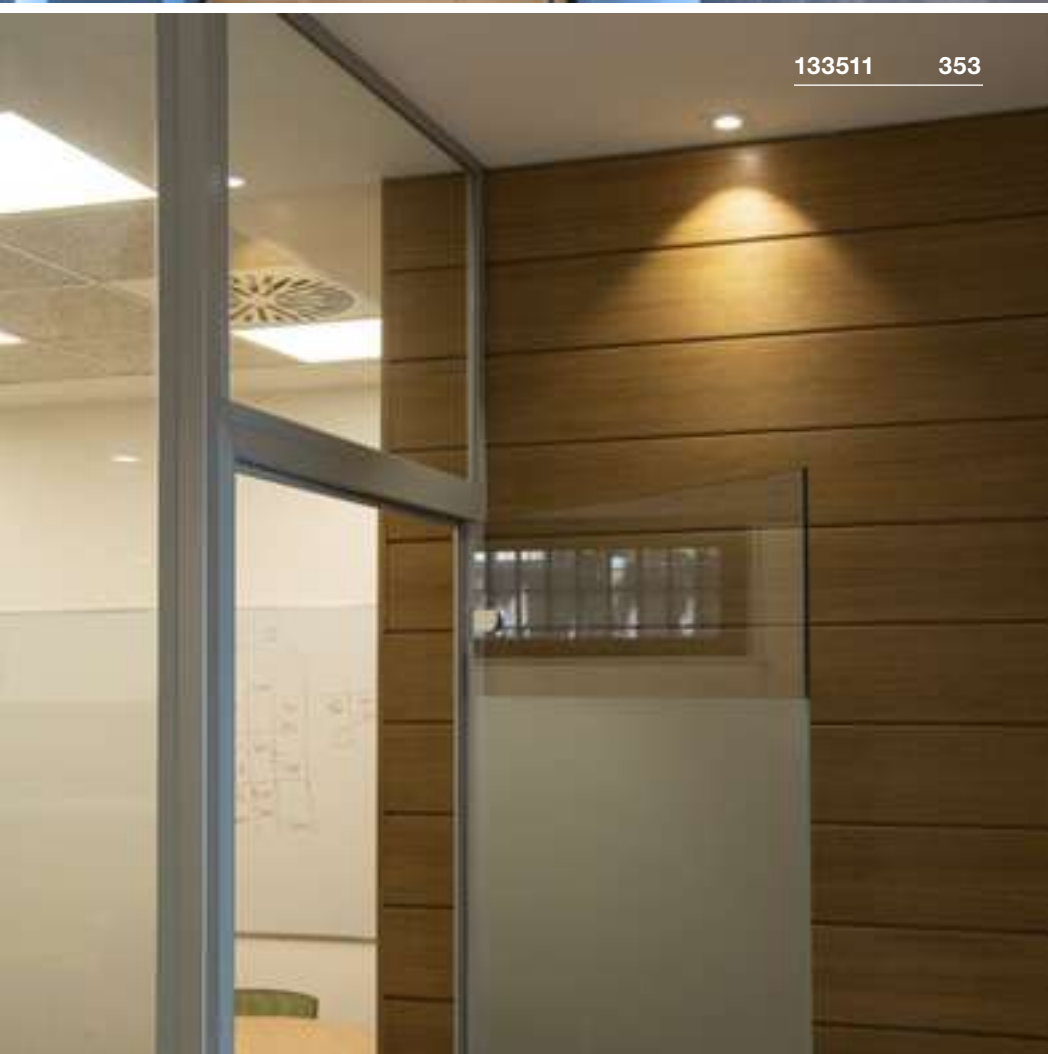

133511 353

NEW TRIA 155
DL, Double, QPAR51

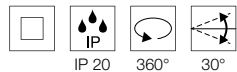
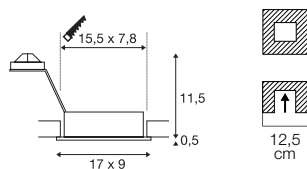

220-240V ~50/60Hz
Material: Aluminium

- Clipfedern
- Materialstärke Einbaulfläche: 30 mm max



GU10 <50W



LED GU10 51mm | 4W | 36°
2700K | 270lm | EEC=G
4kWh/1000h



Art. Nr. 1004972

Variante	Art. Nr.
2xGU10	
■ schwarz	113492
2xGU10	
□ weiß	113512
2xGU10	
■ aluminium	111362

113492 354

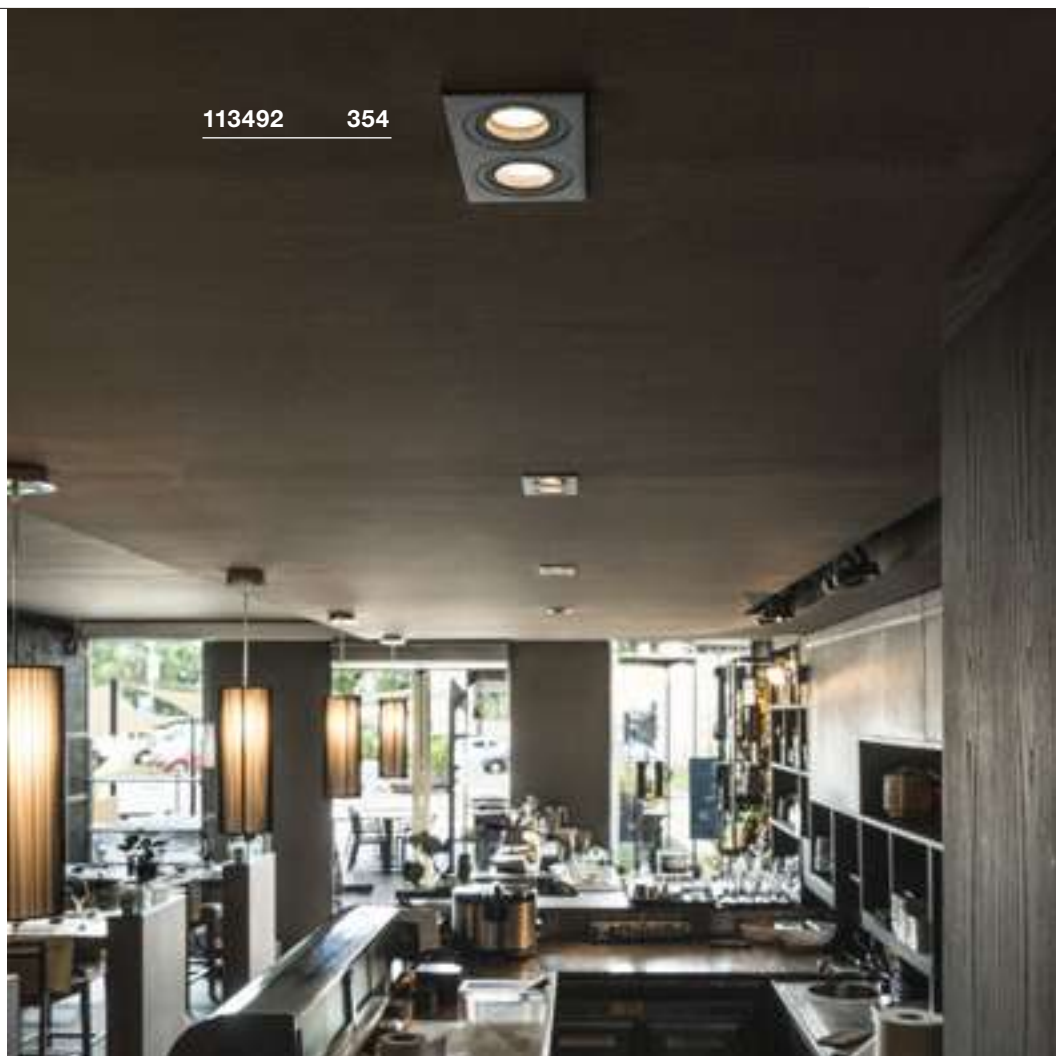

113841 355

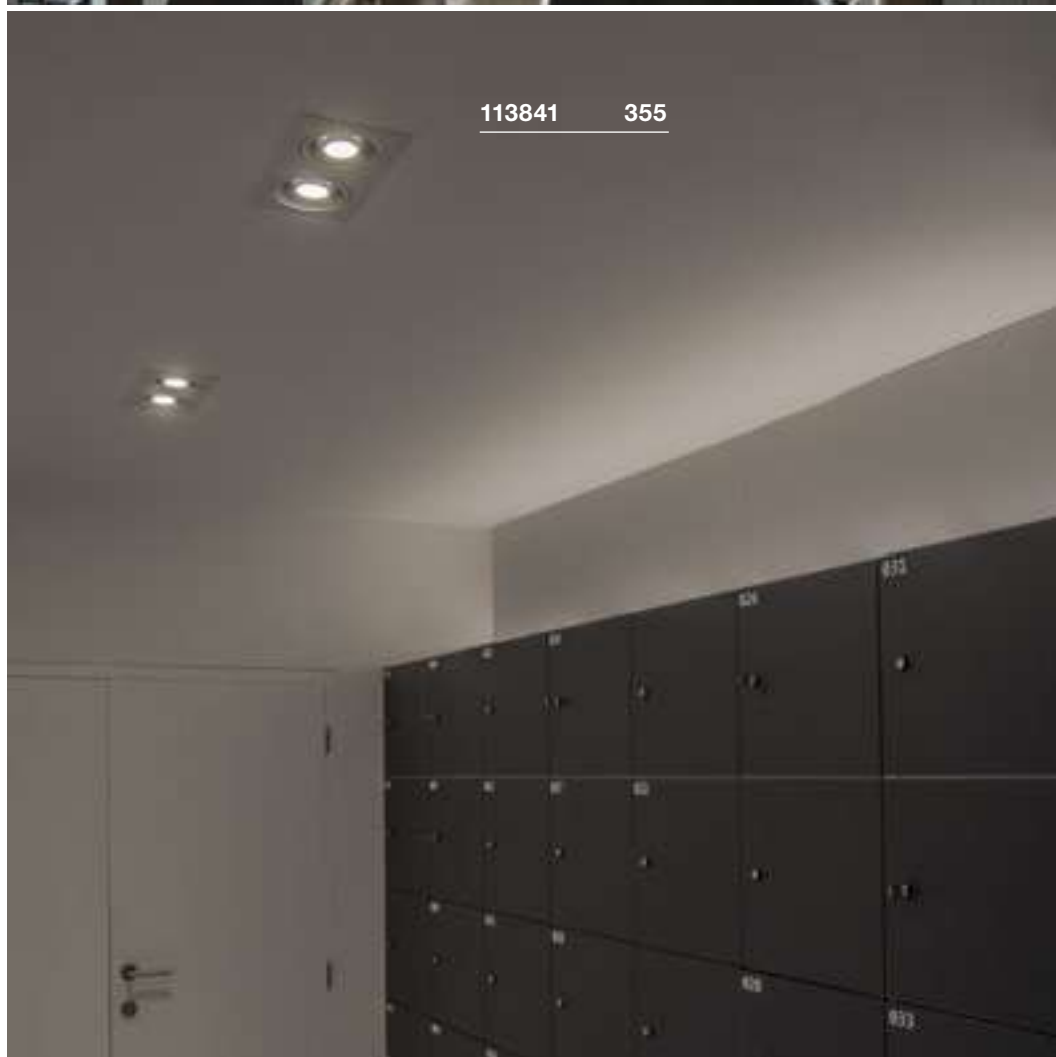

NEW TRIA 150
DL, rund, QPAR111

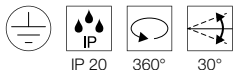
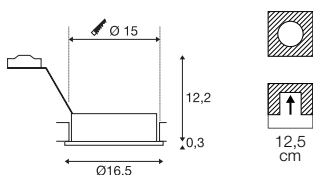

230V ~50Hz
Material: Aluminium

- Blattfedern
- Materialstärke Einbaufäche: 30 mm max.



QPAR111 | 12,5W | 30°
4000K | 1000lm | EEK=F
13kWh/1000h



Art. Nr. 1005282

Variante	Art. Nr.
1xGU10	
■ schwarz	113550
1xGU10	
□ weiß	113540
1xGU10	
■ aluminium	111380

NEW TRIA 150
DL, eckig, QPAR111

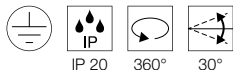
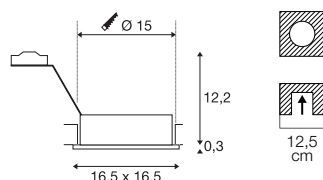

230V ~50Hz
Material: Aluminium

- Blattfedern
- Materialstärke Einbaufäche: 30 mm max.



GU10 <75W



QPAR111 | 8W | 38°
2700K | 680lm | EEK=F
8kWh/1000h



Art. Nr. 1005274

Variante	Art. Nr.
1xGU10	
■ schwarz	113830
1xGU10	
□ weiß	113541
1xGU10	
■ aluminium	111381

NEW TRIA 300
DL, Double, QPAR111

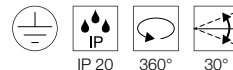
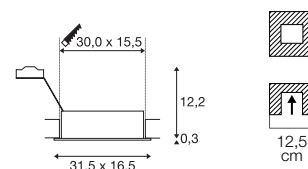

230V ~50Hz
Material: Aluminium

- Clipfedern
- Materialstärke Einbaufäche: 30 mm max.



GU10 <75W



LED E27 | 7.3W | 25°
3000K | 530lm | EEK=F
7kWh/1000h



Art. Nr. 1005292

Variante	Art. Nr.
2xGU10	
■ schwarz	113840
2xGU10	
□ weiß	113841
2xGU10	
■ aluminium	111382

NEW TRIA 45
DL, rund

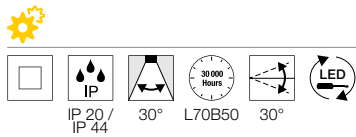
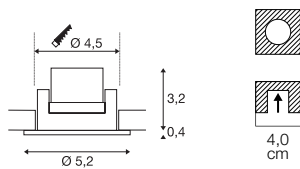
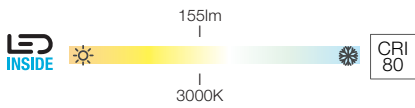

220-240V ~50/60Hz | 700mA
Systemleistung: 4,2W
Material: Aluminium

- Clipfedern
- Materialstärke Einbaufäche: 20 mm max.

NEW TRIA 45
Single, quadratisch, CS

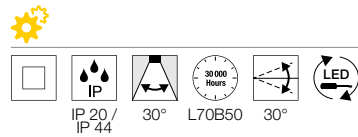
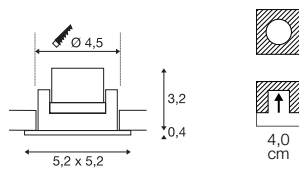
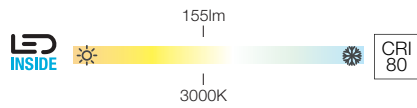
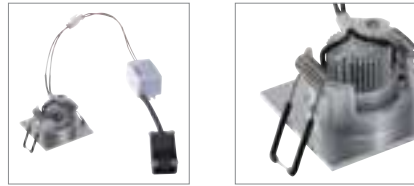

220-240V ~50/60Hz | 700mA
Systemleistung: 4,2W
Material: Aluminium

- Clipfedern
- Materialstärke Einbaufäche: 20 mm max.

113970, 113971, 113976	155lm 3000K	

113970, 113971, 113976	155lm 3000K	

Variante	Art. Nr.
155lm 3000K CRI80	
■ schwarz	113970
155lm 3000K CRI80	
□ weiß	113971
155lm 3000K CRI80	
■ aluminium	113976

Variante	Art. Nr.
155lm 3000K CRI80	
■ schwarz	114400
155lm 3000K CRI80	
□ weiß	114401
155lm 3000K CRI80	
■ aluminium	114406



113971 356



114401 356



113956 357



113966 357

NEW TRIA 68
DL, rund

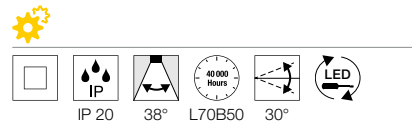
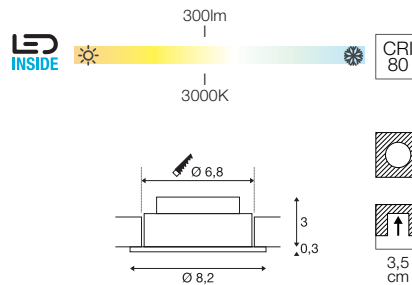

100-240V ~50/60Hz | 350mA
Systemleistung: 5,3W
Material: Aluminium

- Clipfedern
- Materialstärke Einbaufäche: 20 mm

1003057, 113951, 113956	300lm 3000K	A → G A G E

Variante	Art. Nr.
300lm 3000K CRI80	
■ schwarz	1003057
300lm 3000K CRI80	
□ weiß	113951
300lm 3000K CRI80	
▒ gebürstet aluminium	113956

NEW TRIA 68
DL, eckig

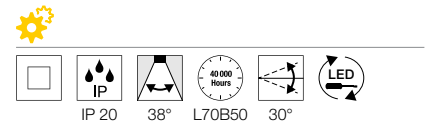
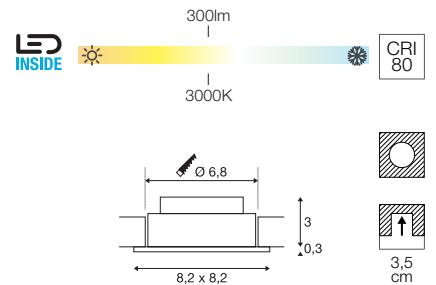

100-240V ~50/60Hz | 350mA
Systemleistung: 5,3W
Material: Aluminium

- Clipfedern
- Materialstärke Einbaufäche: 20 mm

1003061, 113961, 113966	300lm 3000K	A → G A G E

Variante	Art. Nr.
300lm 3000K CRI80	
■ schwarz	1003061
300lm 3000K CRI80	
□ weiß	113961
300lm 3000K CRI80	
▒ gebürstet aluminium	113966

NEW TRIA 68
DL, rund



NEW TRIA 68
DL, rund

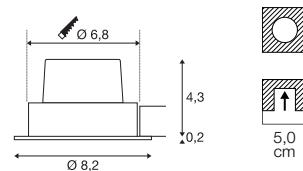
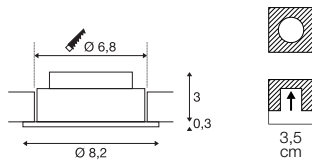
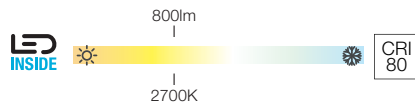
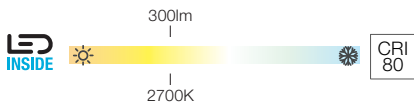

100-240V ~50/60Hz | 350mA
Systemleistung: 5,3W
Material: Aluminium

- Clipfedern und Blattfedern
- Materialstärke Einbaufäche: 20 mm

220-240V ~50/60Hz | 500mA
Systemleistung: 11W
Material: Aluminium

- Clipfedern und Blattfedern
- Materialstärke Einbaufäche: 20 mm

1003058, 1003059, 1003060	300lm 2700K	

1003065, 1003066, 1003067	800lm 2700K	

Variante	Art. Nr.
300lm 2700K CRI80	
■ schwarz	1003058
300lm 2700K CRI80	
□ weiß	1003059
300lm 2700K CRI80	
▒ gebürstet aluminium	1003060

Variante	Art. Nr.
800lm 2700K CRI80	
■ schwarz	1003065
800lm 2700K CRI80	
□ weiß	1003066
800lm 2700K CRI80	
▒ gebürstet aluminium	1003067





1003059 358



NEW TRIA 68
DL, eckig, PHASE

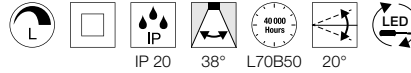
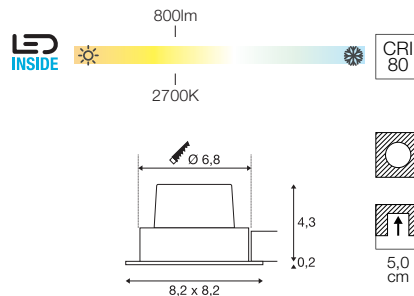

220-240V ~50/60Hz | 500mA
Systemleistung: 11W
Material: Aluminium

- Clipfedern und Blattfedern
- Materialstärke Einbaufäche: 20 mm



1003068, 1003069, 1003070	800lm 2700K	

Variante	Art. Nr.
800lm 2700K CRI80	
■ schwarz	1003068
800lm 2700K CRI80	
□ weiß	1003069
800lm 2700K CRI80	
▒ gebürstet aluminium	1003070

NEW TRIA 68
DL, eckig

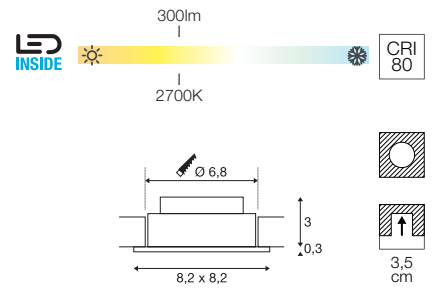

100-240V ~50/60Hz | 350mA
Systemleistung: 5,3W
Material: Aluminium

- Clipfedern und Blattfedern
- Materialstärke Einbaufäche: 20 mm



1003062, 1003063, 1003064	300lm 2700K	

Variante	Art. Nr.
300lm 2700K CRI80	
■ schwarz	1003062
300lm 2700K CRI80	
□ weiß	1003063
300lm 2700K CRI80	
▒ gebürstet aluminium	1003064

1003066 358



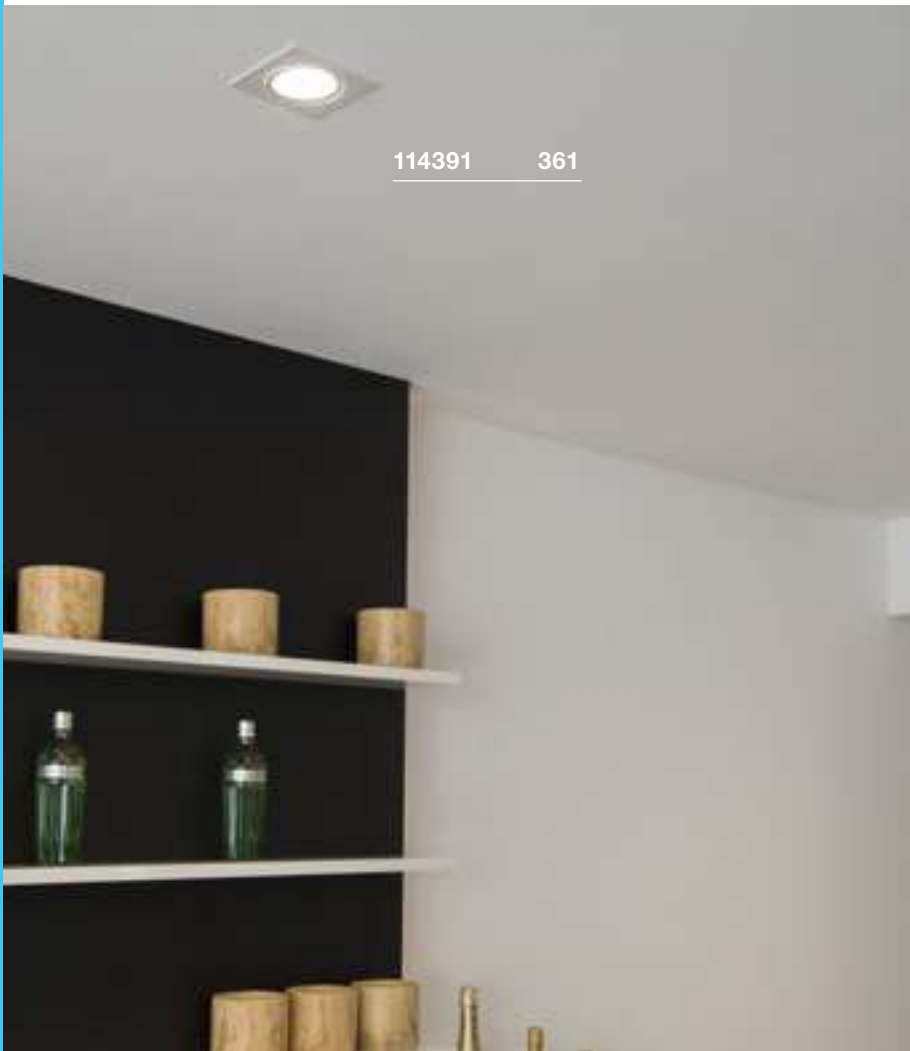

NEW TRIA 68
DL, rund, PHASE

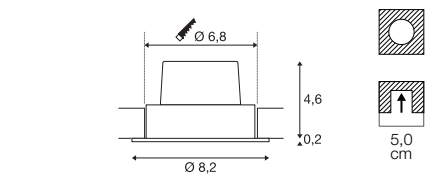
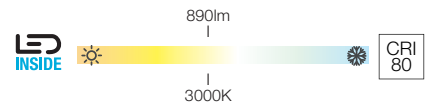

220-240V ~50/60Hz | 500mA
Systemleistung: 11W
Material: Aluminium

- Clipfedern und Blattfedern
- Materialstärke Einbaufäche: 20 mm

114380, 114381, 114386	890lm 3000K	

Variante	Art. Nr.
890lm 3000K CRI80 ■ schwarz	114380
890lm 3000K CRI80 □ weiß	114381
890lm 3000K CRI80 ▒ gebürstet aluminium	114386

NEW TRIA 68
DL, eckig, PHASE

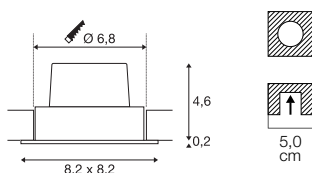
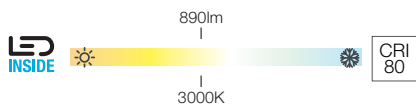

220-240V ~50/60Hz | 500mA
Systemleistung: 11W
Material: Aluminium

- Clipfedern und Blattfedern
- Materialstärke Einbaufäche: 20 mm

114390, 114391, 114396	890lm 3000K	

Variante	Art. Nr.
890lm 3000K CRI80	
■ schwarz	114390
890lm 3000K CRI80	
□ weiß	114391
890lm 3000K CRI80	
▒ gebürstet aluminium	114396

NEW TRIA 68
DL, rund, PHASE

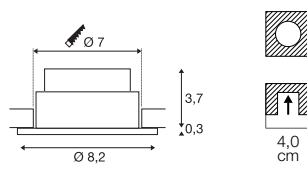
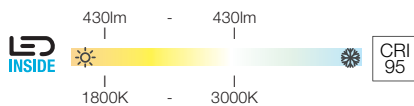

220-240V ~50/60Hz | 350mA
Systemleistung: 7,2W
Material: Aluminium

- Clipfedern und Blattfedern
- Materialstärke Einbaufäche: 20 mm

1001978, 1001989, 1001990	430lm 1800-3000K	

Variante	Art. Nr.
430lm 1800-3000K CRI95	
■ schwarz	1001978
430lm 1800-3000K CRI95	
□ weiß	1001989
430lm 1800-3000K CRI95	
▒ gebürstet aluminium	1001990

NEW TRIA 68
DL, eckig, PHASE

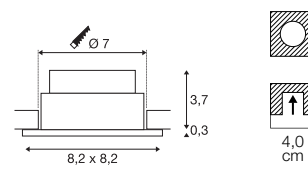
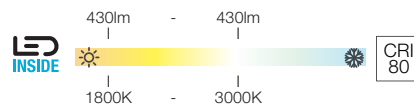

220-240V ~50/60Hz | 350mA
Systemleistung: 7,2W
Material: Aluminium

- Clipfedern und Blattfedern
- Materialstärke Einbaufäche: 20 mm

1001991, 1001992, 1001993	430lm 1800-3000K	

Variante	Art. Nr.
430lm 1800-3000K CRI80	
■ schwarz	1001991
430lm 1800-3000K CRI80	
□ weiß	1001992
430lm 1800-3000K CRI80	
▒ gebürstet aluminium	1001993

NEW TRIA 77
DL, rund

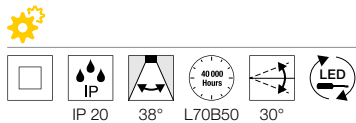
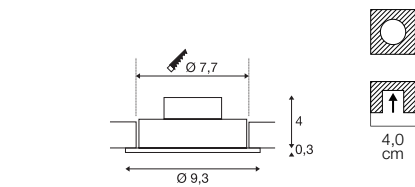
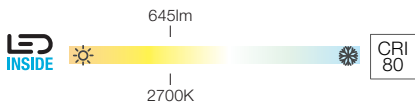

220-240V ~50/60Hz | 350mA
Systemleistung: 8W
Material: Aluminium

- Clipfedern
- Materialstärke Einbaufäche: 20 mm max.

NEW TRIA 77
DL, eckig

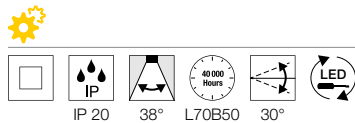
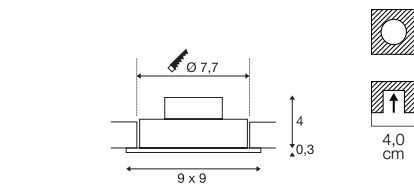
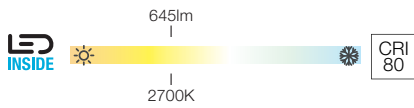

220-240V ~50/60Hz | 350mA
Systemleistung: 8W
Material: Aluminium

- Clipfedern
- Materialstärke Einbaufäche: 20 mm max.

NEW TRIA 77
DL, rund

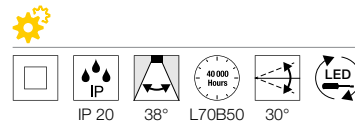
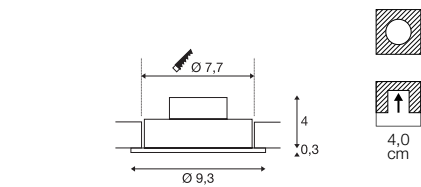
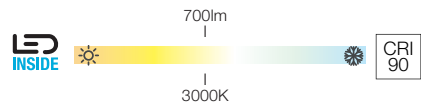

220-240V ~50/60Hz | 350mA
Systemleistung: 8W
Material: Aluminium

- Clipfedern
- Materialstärke Einbaufäche: 20 mm max.

113870, 113871, 113876	645lm 2700K	

113880, 113881, 113886	645lm 2700K	

113900, 113901, 113906	700lm 3000K	

Variante	Art. Nr.
645lm 2700K CRI80	
■ schwarz	113870
645lm 2700K CRI80	
□ weiß	113871
645lm 2700K CRI80	
▒ aluminium	113876

Variante	Art. Nr.
645lm 2700K CRI80	
■ schwarz	113880
645lm 2700K CRI80	
□ weiß	113881
645lm 2700K CRI80	
▒ aluminium	113886

Variante	Art. Nr.
700lm 3000K CRI80	
■ schwarz	113900
700lm 3000K CRI80	
□ weiß	113901
700lm 3000K CRI80	
▒ aluminium	113906

NEW TRIA 77
DL, eckig

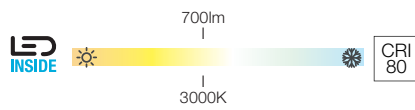
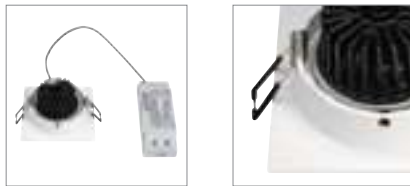

CRI 80

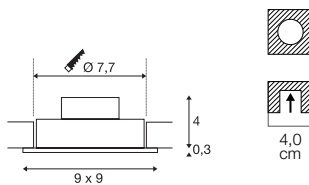

4,0 cm

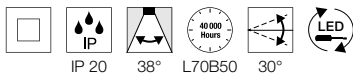

220-240V ~50/60Hz | 350mA
Systemleistung: 8W
Material: Aluminium

- Clipfedern
- Materialstärke Einbaufäche: 20 mm max.



		A → G
113910, 113911, 113916	700lm 3000K	A C E

Variante	Art. Nr.
700lm 3000K CRI80	
■ schwarz	113910
700lm 3000K CRI80	
□ weiß	113911
700lm 3000K CRI80	
■ aluminium	113916

113916 363



NEW TRIA 155
DL, Double



113891 364

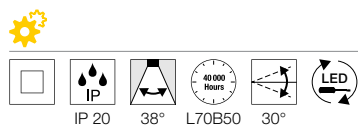
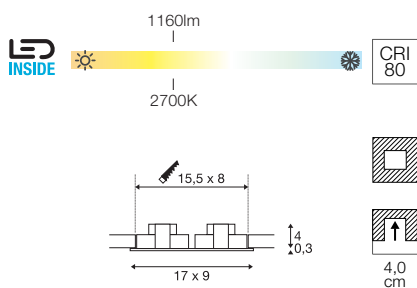

220-240V ~50/60Hz | 350mA
Systemleistung: 14W
Material: Aluminium

- Clipfedern
- Materialstärke Einbaufäche: 30 mm max.

113890, 113891, 113896	1160lm 2700K	

Variante	Art. Nr.
1160lm 2700K CRI80	
■ schwarz	113890
1160lm 2700K CRI80	
□ weiß	113891
1160lm 2700K CRI80	
■ aluminium	113896





113890 364

NEW TRIA 155
DL, Double

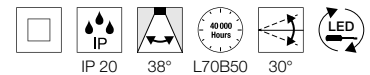
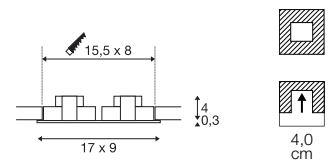
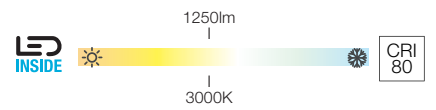

220-240V ~50/60Hz | 350mA
Systemleistung: 14W
Material: Aluminium

- Clipfedern
- Materialstärke Einbaufäche: 30 mm max.



113920, 113921, 113926	1250lm 3000K	

Variante	Art. Nr.
1250lm 3000K CRI80 ■ schwarz	113920
1250lm 3000K CRI80 □ weiß	113921
1250lm 3000K CRI80 ■ aluminium	113926

NEW TRIA 110
DL, rund, PHASE



NEW TRIA 110
DL, rund, PHASE



NEW TRIA 110
DL, eckig, PHASE

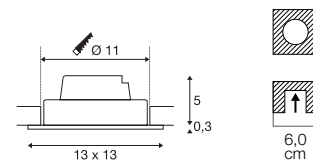
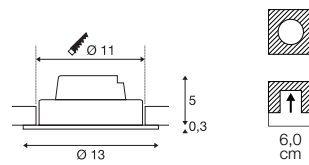
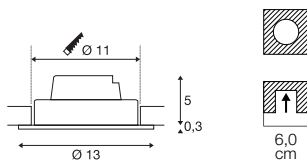
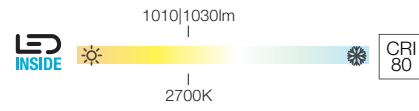
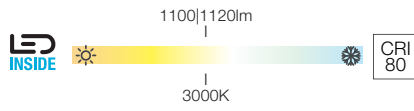
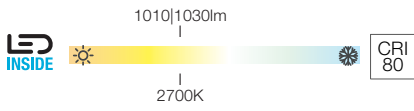

IP 20 38° L70B50 360° 20°

IP 20 38° L70B50 360° 20°

IP 20 38° L70B50 360° 20°

220-240V ~50/60Hz | 350mA
Systemleistung: 14W
Material: Aluminium

220-240V ~50/60Hz | 350mA
Systemleistung: 14W
Material: Aluminium

220-240V ~50/60Hz | 350mA
Systemleistung: 14W
Material: Aluminium

- Clipfedern
- Materialstärke Einbaufäche: 20 mm max.

- Clipfedern
- Materialstärke Einbaufäche: 20 mm max.

- Clipfedern
- Materialstärke Einbaufäche: 20 mm max.

114220, 114221	1010lm 1030lm 2700K	

114230, 114231	1100lm 1120lm 3000K	

114240, 114241	1010lm 1030lm 2700K	

Variante	Art. Nr.
1010lm 2700K CRI80	
■ schwarz	114220
1030lm 2700K CRI80	
□ weiß	114221

Variante	Art. Nr.
1100lm 3000K CRI80	
■ schwarz	114230
1120lm 3000K CRI80	
□ weiß	114231

Variante	Art. Nr.
1010lm 2700K CRI80	
■ schwarz	114240
1030lm 2700K CRI80	
□ weiß	114241

NEW TRIA 110
DL, eckig, PHASE

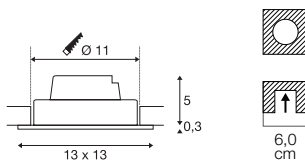
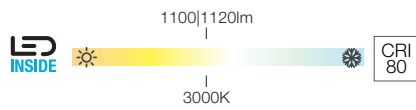

220-240V ~50/60Hz | 350mA
Systemleistung: 14W
Material: Aluminium

- Clipfedern
- Materialstärke Einbaufäche: 20 mm max.

		A → G
114250, 114251	1100lm 1120lm 3000K	A → G E

Variante	Art. Nr.
1100lm 3000K CRI80	
■ schwarz	114250
1120lm 3000K CRI80	
□ weiß	114251

114231 366



NEW TRIA 150
DL, rund, 1-10V

NEW TRIA 150
DL, rund, 1-10V

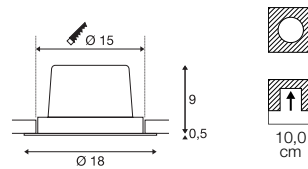
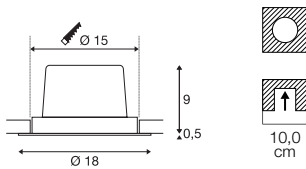
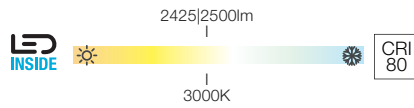
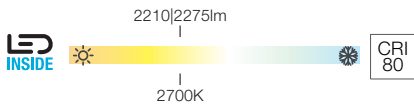

IP 20 30° L70B50 360° 20°

IP 20 30° L70B50 360° 20°

100-240V ~50/60Hz | 700mA
Systemleistung: 29W
Material: Aluminium

100-240V ~50/60Hz | 700mA
Systemleistung: 29W
Material: Aluminium

- Clipfedern
- Materialstärke Einbaufäche: 20 mm max.

- Clipfedern
- Materialstärke Einbaufäche: 20 mm max.

114260, 114261	2210lm 2275lm 2700K	

114270, 114271	2425lm 2500lm 3000K	

Variante	Art. Nr.
2210lm 2700K CRI80	
■ schwarz	114260
2275lm 2700K CRI80	
□ weiß	114261

Variante	Art. Nr.
2425lm 3000K CRI80	
■ schwarz	114270
2500lm 3000K CRI80	
□ weiß	114271

114271 368

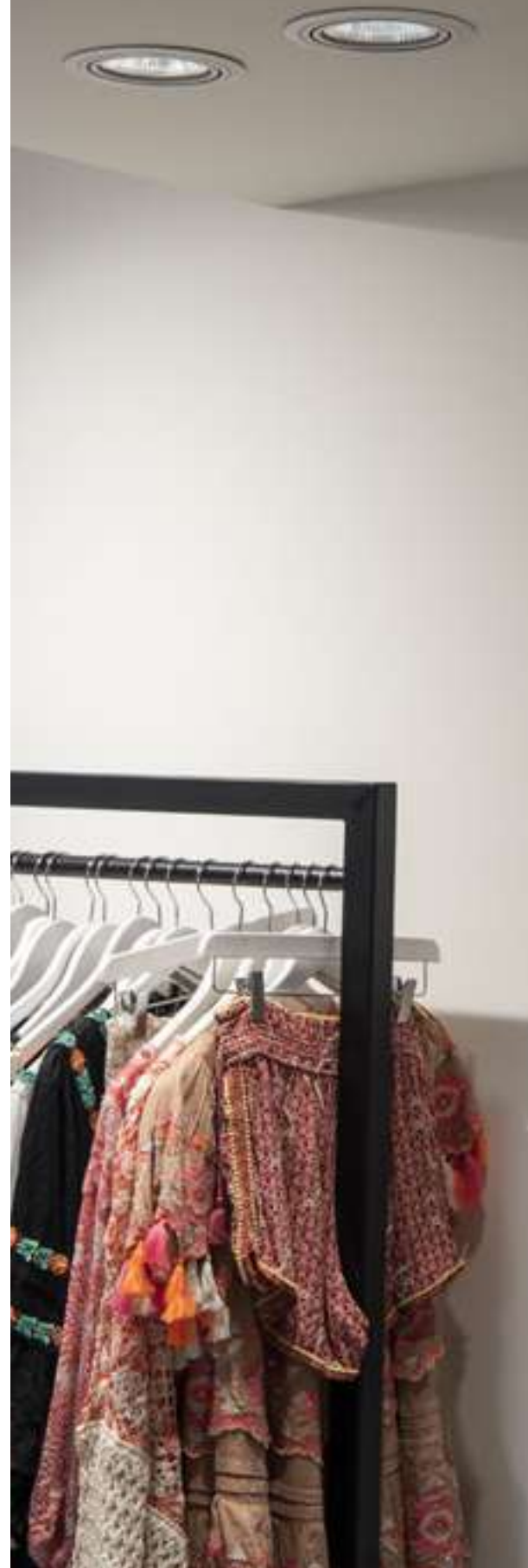



114271 369

NEW TRIA 150
DL, eckig, 1-10V

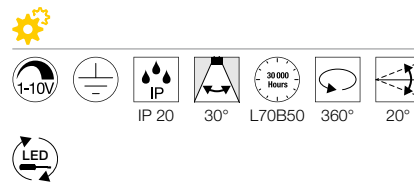
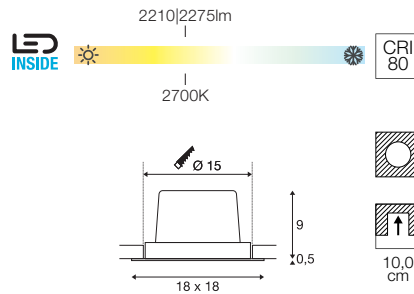

100-240V ~50/60Hz | 700mA
Systemleistung: 29W
Material: Aluminium

- Clipfedern
- Materialstärke Einbaufäche: 20 mm max.

114280, 114281	2210lm 2275lm 2700K	

Variante	Art. Nr.
2210lm 2700K CRI80	
■ schwarz	114280
2275lm 2700K CRI80	
□ weiß	114281

NEW TRIA 150
DL, eckig, 1-10V

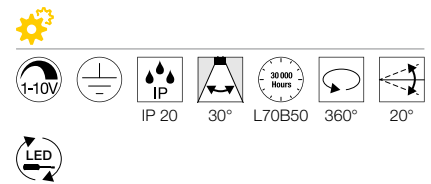
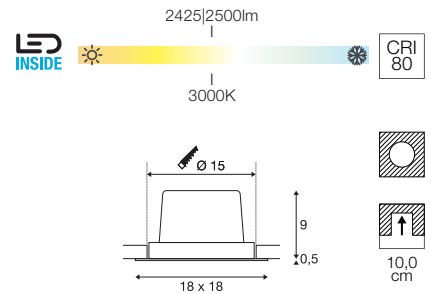

100-240V ~50/60Hz | 700mA
Systemleistung: 29W
Material: Aluminium

- Clipfedern
- Materialstärke Einbaufäche: 20 mm max.

114290, 114291	2425lm 2500lm 3000K	

Variante	Art. Nr.
2425lm 3000K CRI80	
■ schwarz	114290
2500lm 3000K CRI80	
□ weiß	114291

HORN MINI
EL

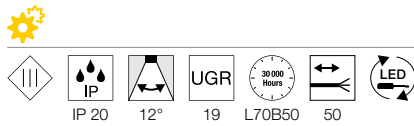
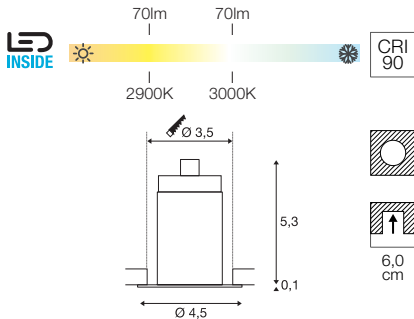

350mA
Leistungsaufnahme: 1W
Material: Aluminium / Polycarbonat (PC)

- Treiber exkl.
- inkl. AMP Stecker
- Bei goldenem Reflektor abweichende Lichtfarbe

1000915, 1000917, 1000914	70lm 2900 3000K	

- Steckerleiste 3 Ausgänge
Art. Nr. 111850
- LED Treiber 350mA | 15W
inkl. Zugentlastung
Art. Nr. 464031

Variante	Art. Nr.
70lm 3000K CRI90	
■ schwarz	1000915
70lm 2900K CRI90	
■ schwarz / gold	1000917
70lm 3000K CRI90	
□ weiß	1000914

HORN
DL, single, QPAR51

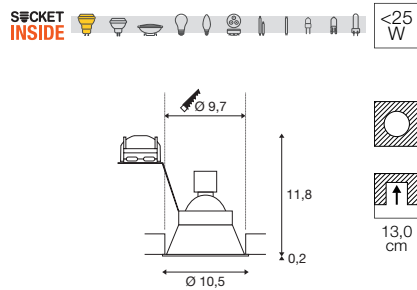

220-240V ~50/60Hz
Material: Aluminium

GU10 <math><25\text{ W}</math>

LED GU10 51mm | 4W | 36°
3000K | 280lm | EEK=F
4kWh/1000h

Art. Nr. 1004973

Variante	Art. Nr.
1xGU10	
■ schwarz	113140
1xGU10	
□ weiß	113141





113110 371

HORN
DL, double, QPAR51

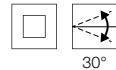
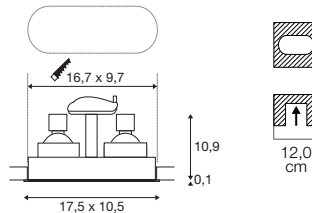

220-240V ~50/60Hz
Material: Aluminium

HORN
DL, single, asymmetrisch, QPAR51

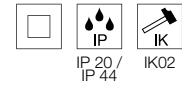
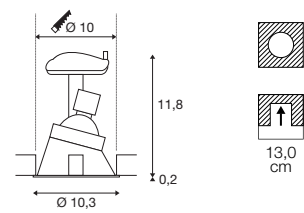

220-240V ~50/60Hz
Material: Aluminium



113151 371

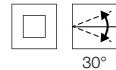

220-240V ~50/60Hz
Material: Aluminium



GU10 <25W



LED GU10 | 6W | 36°
2700K | 900lm | EEK=G
6kWh/1000h

Art. Nr. 1005273



GU10 <25W



LED GU10 | 6W | 38°
2700K | 450lm | EEK=G
6kWh/1000h

Art. Nr. 1005077



Variante	Art. Nr.
2xGU10	
■ schwarz	1006121
2xGU10	
□ weiß	1006122

Variante	Art. Nr.
1xGU10	
■ schwarz	113150
1xGU10	
□ weiß	113151

HORN
DL, single, QPAR51

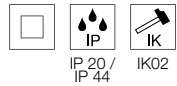
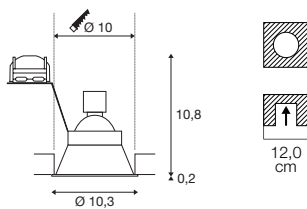
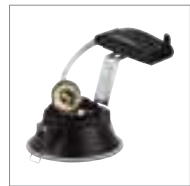

220-240V ~50/60Hz
Material: Aluminium

HORN
EL, single, QPAR51

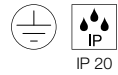
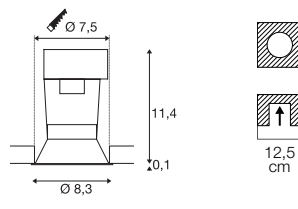

220-240V ~50/60Hz
Material: Stahl

- Materialstärke Einbauffläche: 45 mm max



GU10 <25W



LED GU10 51mm | 4W | 36°
3000K | 280lm | EEK=F
4kWh/1000h

Art. Nr. 1004973



GU10 <50W



LED GU10 51mm | 4W | 36°
4000K | 290lm | EEK=F
4kWh/1000h

Art. Nr. 1004974



Variante	Art. Nr.
1xGU10	
■ schwarz	113160
1xGU10	
□ weiß	113161

Variante	Art. Nr.
1xGU10	
■ schwarz	112910
1xGU10	
□ weiß	112911



113161 372



112911 372

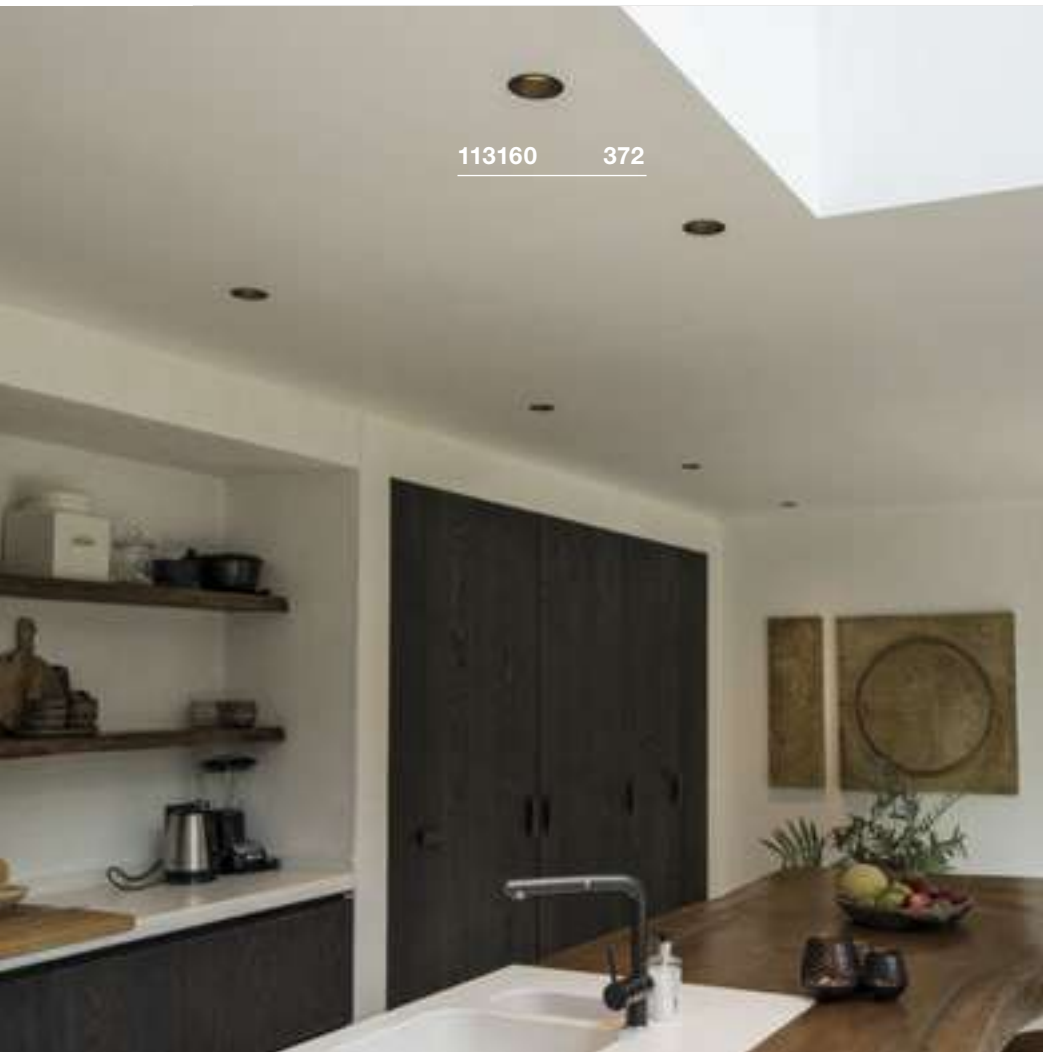

113160 372

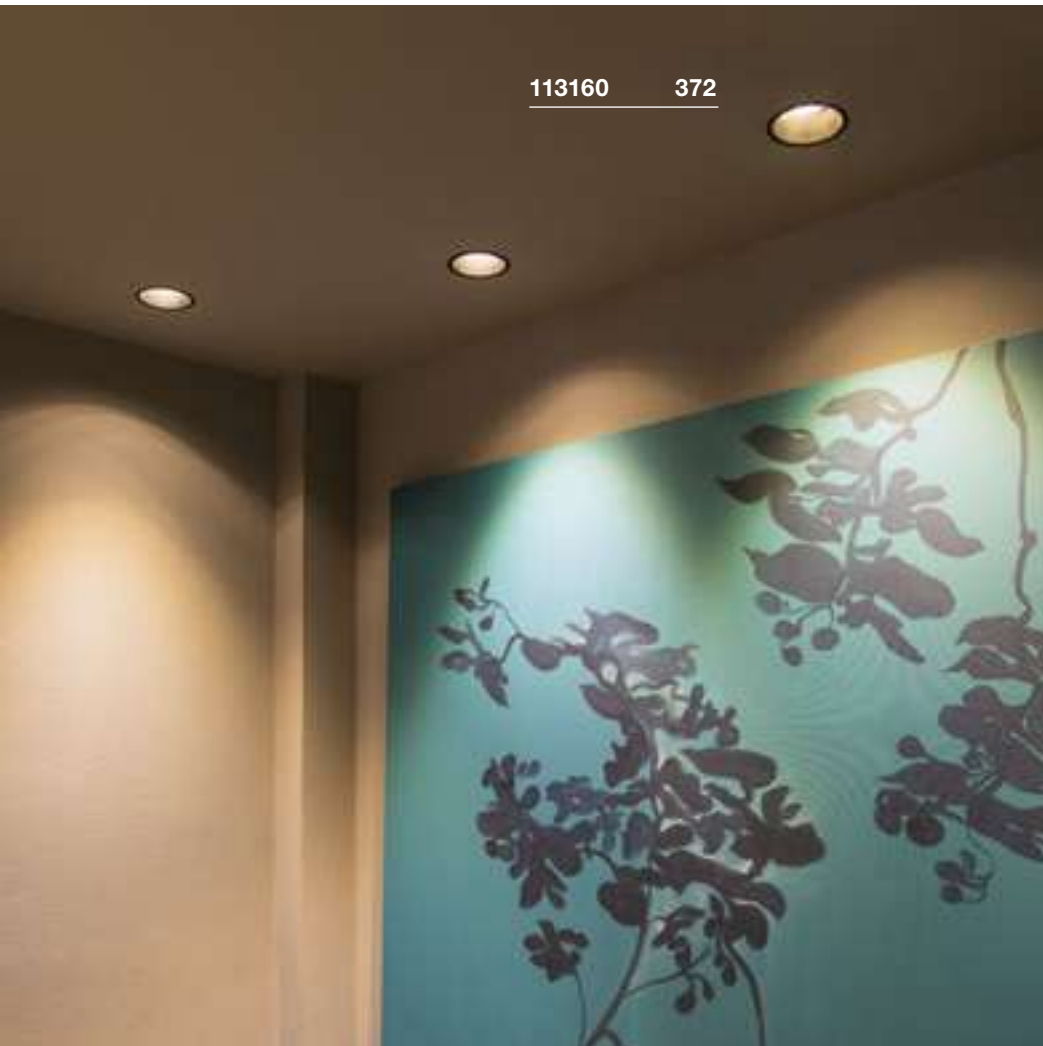

113160 372

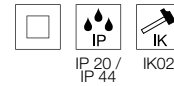
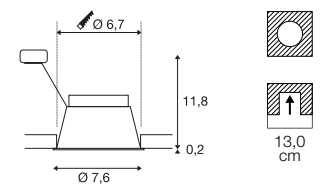
HORN
DL, GU10, Blower Door getestet**NEW VARIANT****SOCKET INSIDE** <25 W220-240V ~50/60Hz
Material: Aluminium

- Das Downlight entspricht den Anforderungen von RT2012.



GU10 <25W

LED GU10 | 6W | 38°
3000K | 450lm | EEK=G
6kWh/1000h

Art. Nr. 1005080

Variante	Art. Nr.
1xGU10	
■ schwarz	1005435
1xGU10	
□ weiß	1005436



1002592 375

HORN MAGNA

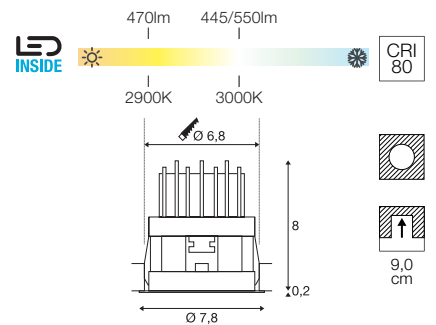
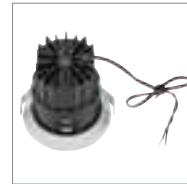

500mA
 Leistungsaufnahme: 6W
 Material: Aluminium / Polycarbonat (PC)

- Clipfedern
- Treiber exkl.
- Bei goldenem Reflektor abweichende Lichtfarbe

1002592, 1002594, 1002591	440/470/550lm 2900K 3000K	

Honeycomb Modul
 Art. Nr. **1002596**

Variante	Art. Nr.
445lm 3000K CRI80 ■ schwarz	1002592
470lm 2900K CRI90 ■ schwarz / gold	1002594
550lm 3000K CRI80 □ weiß	1002591

KADUX
EL, single, QPAR51

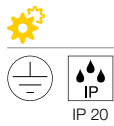
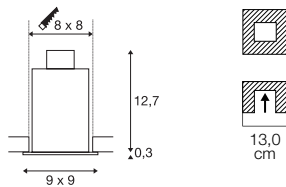

220-240V ~50/60Hz
Material: Aluminium / Stahl

- Clipfedern
- Materialstärke Einbaufäche: 30 mm max.

KADUX
EL, double, QPAR51

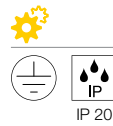
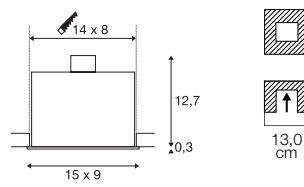

220-240V ~50/60Hz
Material: Aluminium / Stahl

- Clipfedern
- Materialstärke Einbaufäche: 30 mm max.

KADUX
EL, triple, QPAR51

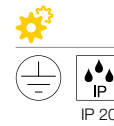
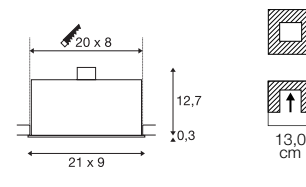

220-240V ~50/60Hz
Material: Aluminium / Stahl

- Clipfedern
- Materialstärke Einbaufäche: 30 mm max.

GU10 <50W

LED GU10 51mm | 6W | 38°
2700K | 450lm | EEK=G
6kWh/1000h

Art. Nr. 1005075

Variante	Art. Nr.
1xGU10	
■ schwarz	115510
1xGU10	
□ weiß	115511

GU10 <50W

LED GU10 51mm | 4W | 36°
2700K | 270lm | EEK=G
4kWh/1000h

Art. Nr. 1004972

Variante	Art. Nr.
2xGU10	
■ schwarz	115520
2xGU10	
□ weiß	115521

GU10 <50W

LED GU10 | 6W | 36°
2700K | 900lm | EEK=G
6kWh/1000h

Art. Nr. 1005273

Variante	Art. Nr.
3xGU10	
■ schwarz	115530
3xGU10	
□ weiß	115531



115521 376



115530 377

KADUX
EL, single, QPAR111

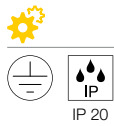
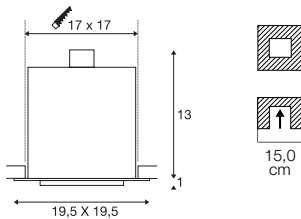

220-240V ~50/60Hz
Material: Aluminium / Stahl

- Clipfedern
- Materialstärke Einbaufäche: 25 mm max.

GU10 <75W

QPAR111 | 8W | 38°
2700K | 680lm | EEK=F
8kWh/1000h



Art. Nr. 1005274

Variante	Art. Nr.
1xGU10	
■ schwarz	115540
1xGU10	
□ weiß	115541

KADUX
EL, double, QPAR111

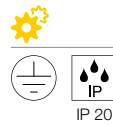
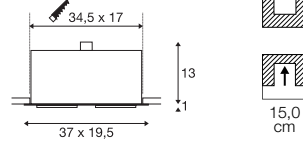

220-240V ~50/60Hz
Material: Aluminium / Stahl

- Clipfedern
- Materialstärke Einbaufäche: 25 mm max.

GU10 <75W

LED GU10 | 12,5W | 10°
2700K | 900lm | EEK=F
13kWh/1000h



Art. Nr. 1005275

Variante	Art. Nr.
2xGU10	
■ schwarz	115550
2xGU10	
□ weiß	115551

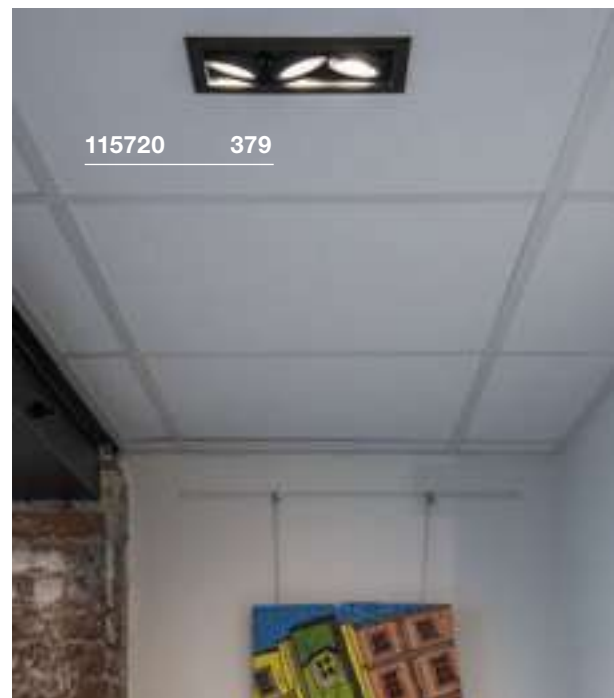
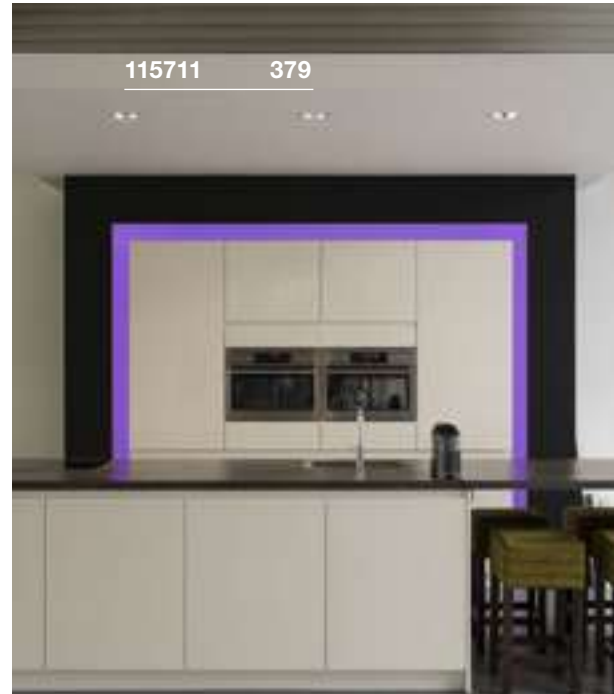

KADUX
EL, single, PHASE

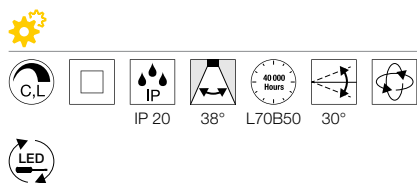
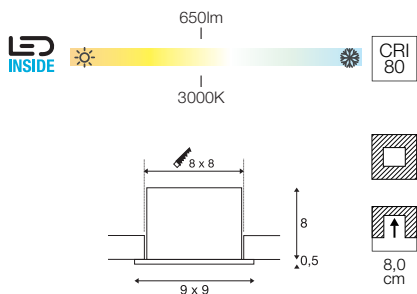

220-240V ~50/60Hz | 350mA
Systemleistung: 7,5W
Material: Aluminium / Stahl

- Clipfedern
- Materialstärke Einbaufäche: 30 mm max.

KADUX
EL, double, PHASE

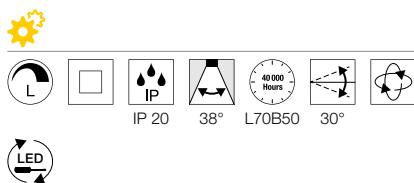
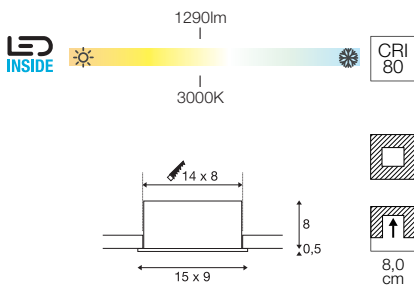

220-240V ~50/60Hz | 350mA
Systemleistung: 14W
Material: Aluminium / Stahl

- Clipfedern
- Materialstärke Einbaufäche: 30 mm max.

KADUX
EL, triple, PHASE

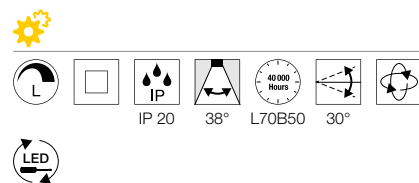
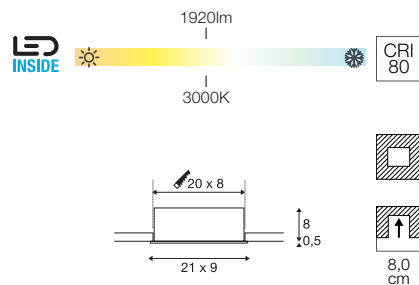

220-240V ~50/60Hz | 350mA
Systemleistung: 20W
Material: Aluminium / Stahl

- Clipfedern
- Materialstärke Einbaufäche: 30 mm max.

115700, 115701	650lm 3000K		

Variante	Art. Nr.
650lm 3000K CRI80 ■ schwarz	115700
650lm 3000K CRI80 □ weiß	115701

115710, 115711	1290lm 3000K		

Variante	Art. Nr.
1290lm 3000K CRI80 ■ schwarz	115710
1290lm 3000K CRI90 □ weiß	115711

115720, 115721	1920lm 3000K		

Variante	Art. Nr.
1920lm 3000K CRI80 ■ schwarz	115720
1920lm 3000K CRI90 □ weiß	115721

KADUX
DL, single, 1-10V

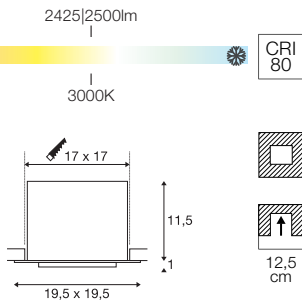

1-10V Dimming
 IP 20
 30°
 L70B50
 30 000 Hours
 LED

100-240V ~50/60Hz | 700mA
Systemleistung: 29W
Material: Aluminium / Stahl

- Clipfedern
- Materialstärke Einbaufäche: 25 mm max.

115730, 115731	2425lm 2500lm 3000K	

1-10V Dimming
Art. Nr. 470505

Variante	Art. Nr.
2425lm 3000K CRI80 ■ schwarz	115730
2500lm 3000K CRI80 □ weiß	115731

KADUX
EL, double, 1-10V

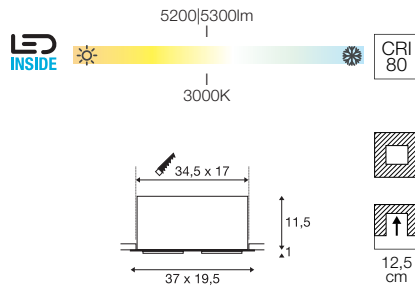

1-10V Dimming
 IP 20
 30°
 L70B50
 30 000 Hours
 LED

100-240V ~50/60Hz | 1400mA
Systemleistung: 54W
Material: Aluminium / Stahl

- Clipfedern
- Materialstärke Einbaufäche: 25 mm max.

115740, 115741	5200lm 5300lm 3000K	

1-10V Dimming
Art. Nr. 470505

Variante	Art. Nr.
5200lm 3000K CRI80 ■ schwarz	115740
5300lm 3000K CRI80 □ weiß	115741





SUPROS 78
EL, PHASE



116310 382

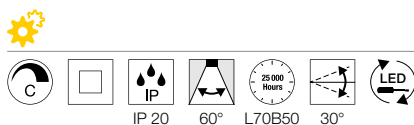
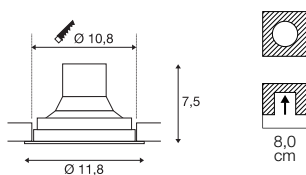

220-240V ~50/60Hz | 250mA
Systemleistung: 12W
Material: Aluminium

- Clipfedern
- Materialstärke Einbaufäche: 25 mm max.

		A → G
116310, 116311	700lm 3000K	A E

- +**
- Linse 20°
Art. Nr. 116302
 - Linse 40°
Art. Nr. 116304

Variante	Art. Nr.
700lm 3000K CRI80 60°	
■ schwarz	116310
700lm 3000K CRI80 60°	
□ weiß	116311





116320 383

SUPROS 78
EL, Move, PHASE

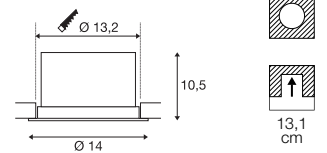
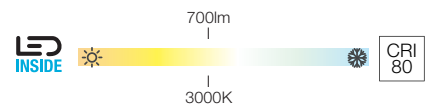

220-240V ~50/60Hz | 250mA
Systemleistung: 12W
Material: Aluminium

- Clipfedern
- Materialstärke Einbaufäche: 25 mm max.

		A → G
116320, 116321	700lm 3000K	A E

- +**
- Linse 20°
Art. Nr. 116302
- Linse 40°
Art. Nr. 116304

Variante	Art. Nr.
700lm 3000K CRI80 60°	
schwarz	116320
700lm 3000K CRI80 60°	
<input type="checkbox"/> weiß	116321

SUPROS DL



SUPROS DL



SUPROS DL

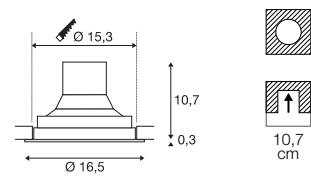
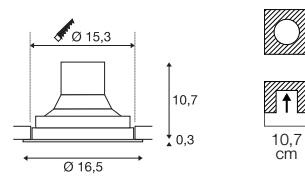
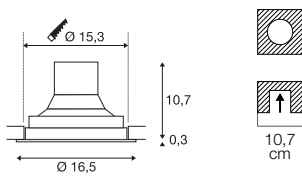
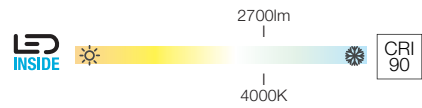
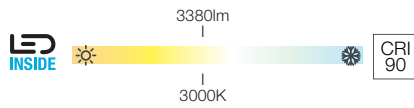
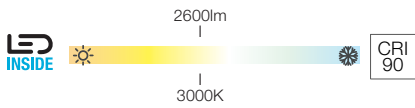

220-240V ~50/60Hz | 750mA
Systemleistung: 31W
Material: Aluminium

220-240V ~50/60Hz | 950mA
Systemleistung: 36W
Material: Aluminium

220-240V ~50/60Hz | 750mA
Systemleistung: 31W
Material: Aluminium

- Clipfedern
- Materialstärke Einbaufäche: 25 mm max.

- Clipfedern
- Materialstärke Einbaufäche: 25 mm max.

- Clipfedern
- Materialstärke Einbaufäche: 25 mm max.

1003299, 1003300	2600lm 3000K	

1003301, 1003302	3380lm 3000K	

1003303, 1003304	2700lm 4000K	

	Reflektor 20° Art. Nr. 114102 Reflektor 40° Art. Nr. 114104	
--	--	------

	Reflektor 20° Art. Nr. 114102 Reflektor 40° Art. Nr. 114104	
--	--	------

	Reflektor 20° Art. Nr. 114102 Reflektor 40° Art. Nr. 114104	
--	--	------

Variante	Art. Nr.
2600lm 3000K CRI90 60°	
■ schwarz	1003299
2600lm 3000K CRI90 60°	
□ weiß	1003300

Variante	Art. Nr.
3380lm 3000K CRI90 60°	
■ schwarz	1003301
3380lm 3000K CRI90 60°	
□ weiß	1003302

Variante	Art. Nr.
2700lm 4000K CRI90 60°	
■ schwarz	1003303
2700lm 4000K CRI90 60°	
□ weiß	1003304

SUPROS
DL

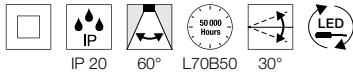
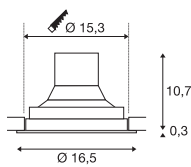
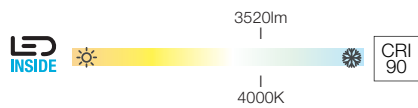

220-240V ~50/60Hz | 950mA
Systemleistung: 36W
Material: Aluminium

- Clipfedern
- Materialstärke Einbaufäche: 25 mm max.



		A → G
1003305, 1003306	3520lm 4000K	A E



	Reflektor 20°	
Art. Nr.	114102	
	Reflektor 40°	
Art. Nr.	114104	

Variante	Art. Nr.
3520lm 4000K CRI90 60°	
■ schwarz	1003305
3520lm 4000K CRI90 60°	
□ weiß	1003306



SUPROS
DL, Move



SUPROS
DL, Move

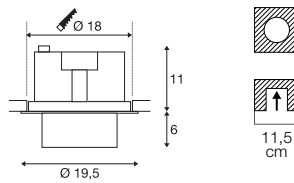
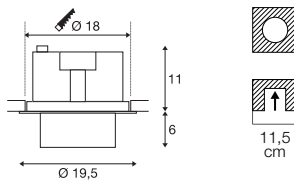
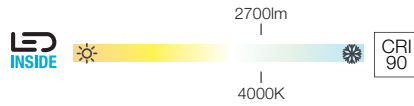
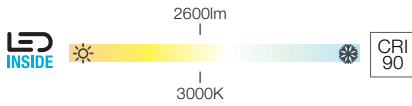

220-240V ~50/60Hz | 750mA
Systemleistung: 31W
Material: Aluminium

220-240V ~50/60Hz | 750mA
Systemleistung: 31W
Material: Aluminium

- Clipfedern
- Materialstärke Einbaufäche: 25 mm

- Clipfedern
- Materialstärke Einbaufäche: 25 mm

1003307, 1003308	2600lm 3000K	

1003311, 1003312	2700lm 4000K	

Reflektor 20° Art. Nr. 114102	
Reflektor 40° Art. Nr. 114104	

Reflektor 20° Art. Nr. 114102	
Reflektor 40° Art. Nr. 114104	

Variante	Art. Nr.
2600lm 3000K CRI90 60°	
■ schwarz	1003307
2600lm 3000K CRI90 60°	
□ weiß	1003308

Variante	Art. Nr.
2700lm 4000K CRI90 60°	
■ schwarz	1003311
2700lm 4000K CRI90 60°	
□ weiß	1003312



1003308 386



1003310 387

SUPROS
DL, Move

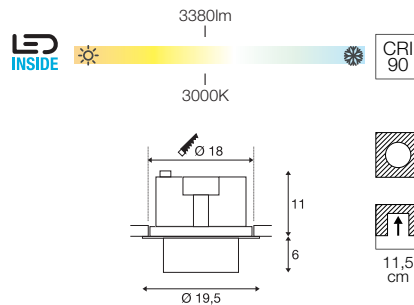

220-240V ~50/60Hz | 950mA
Systemleistung: 36W
Material: Aluminium

- Clipfedern
- Materialstärke Einbaufäche: 25 mm



1003309, 1003310	3380lm 3000K	



- Reflektor 20°
Art. Nr. 114102
- Reflektor 40°
Art. Nr. 114104

Variante	Art. Nr.
3380lm 3000K CRI90 60°	
■ schwarz	1003309
3380lm 3000K CRI90 60°	
□ weiß	1003310

SUPROS
DL, Move

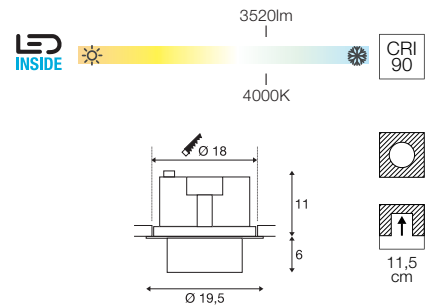

220-240V ~50/60Hz | 950mA
Systemleistung: 36W
Material: Aluminium

- Clipfedern
- Materialstärke Einbaufäche: 25 mm



1003313, 1003314	3520lm 4000K	



- Reflektor 20°
Art. Nr. 114102
- Reflektor 40°
Art. Nr. 114104

Variante	Art. Nr.
3520lm 4000K CRI90 60°	
■ schwarz	1003313
3520lm 4000K CRI90 60°	
□ weiß	1003314

1003008 389

N°10
HAIRROOM

SENDER 12
EL, rund



SENDER 18
EL, rund



SENDER 24
EL, rund

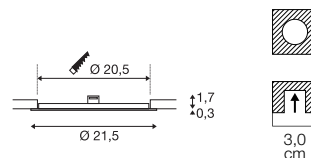
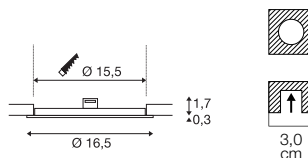
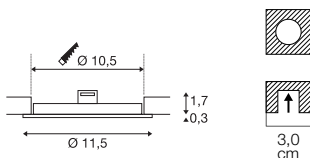
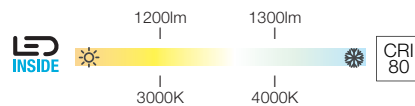
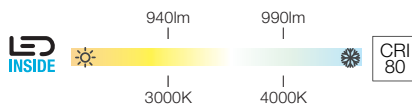
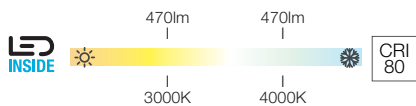
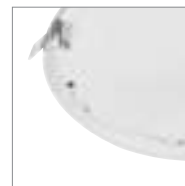

200mA
Leistungsaufnahme: 7W
Material: Aluminium

350mA
Leistungsaufnahme: 12W
Material: Aluminium

500mA
Leistungsaufnahme: 13W
Material: Aluminium

- Clipfedern
- Treiber exkl.

- Clipfedern
- Treiber exkl.

- Clipfedern
- Treiber exkl.

1003008, 1004694	470lm 440lm 3000 4000K	

1003009, 1004695	940lm 990lm 3000K 4000K	

1003010, 1004696	1200lm 1300lm 3000K 4000K	

LED Treiber 10W | 200mA | dimmbar | inkl. Zugentlastung
Art. Nr. 1003254

LED Treiber 15W | 350mA | dimmbar | inkl. Zugentlastung
Art. Nr. 1002803

LED Treiber 15W | 500mA | dimmbar | inkl. Zugentlastung
Art. Nr. 464144

Variante	Art. Nr.
470lm 3000K CRI80 <input type="checkbox"/> weiß	1003008
470lm 4000K CRI90 <input type="checkbox"/> weiß	1004694

Variante	Art. Nr.
940lm 3000K CRI80 <input type="checkbox"/> weiß	1003009
990lm 4000K CRI90 <input type="checkbox"/> weiß	1004695

Variante	Art. Nr.
1200lm 3000K CRI80 <input type="checkbox"/> weiß	1003010
1300lm 4000K CRI90 <input type="checkbox"/> weiß	1004696

SENDER 12
EL, rund



SENDER 18
EL, rund



SENDER 24
EL, rund

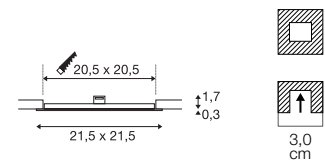
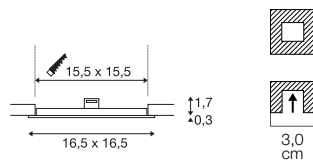
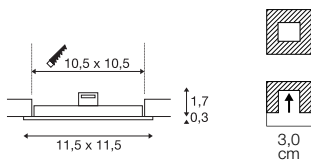
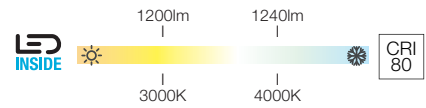
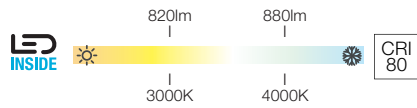
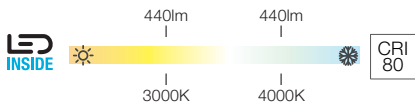
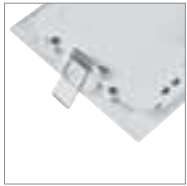

200mA
Leistungsaufnahme: 7W
Material: Aluminium

350mA
Leistungsaufnahme: 12W
Material: Aluminium

500mA
Leistungsaufnahme: 13W
Material: Aluminium

- Clipfedern
- Treiber exkl.

- Clipfedern
- Treiber exkl.

- Clipfedern
- Treiber exkl.

1003011, 1004697	440lm 3000K 4000K	

1003012, 1004698	820lm 880lm 3000K 4000K	

1003013, 1004699	1200lm 1240lm 3000K 4000K	

LED Treiber 10W | 200mA | dimmbar | inkl. Zugentlastung
Art. Nr. 1003254



LED Treiber 15W | 350mA | dimmbar | inkl. Zugentlastung
Art. Nr. 1002803



LED Treiber 15W | 500mA | dimmbar | inkl. Zugentlastung
Art. Nr. 464144



Variante	Art. Nr.
440lm 3000K CRI80 <input type="checkbox"/> weiß	1003011
440lm 4000K CRI90 <input type="checkbox"/> weiß	1004697

Variante	Art. Nr.
820lm 3000K CRI80 <input type="checkbox"/> weiß	1003012
880lm 4000K CRI90 <input type="checkbox"/> weiß	1004698

Variante	Art. Nr.
1200lm 3000K CRI80 <input type="checkbox"/> weiß	1003013
1240lm 4000K CRI90 <input type="checkbox"/> weiß	1004699



1003011 390

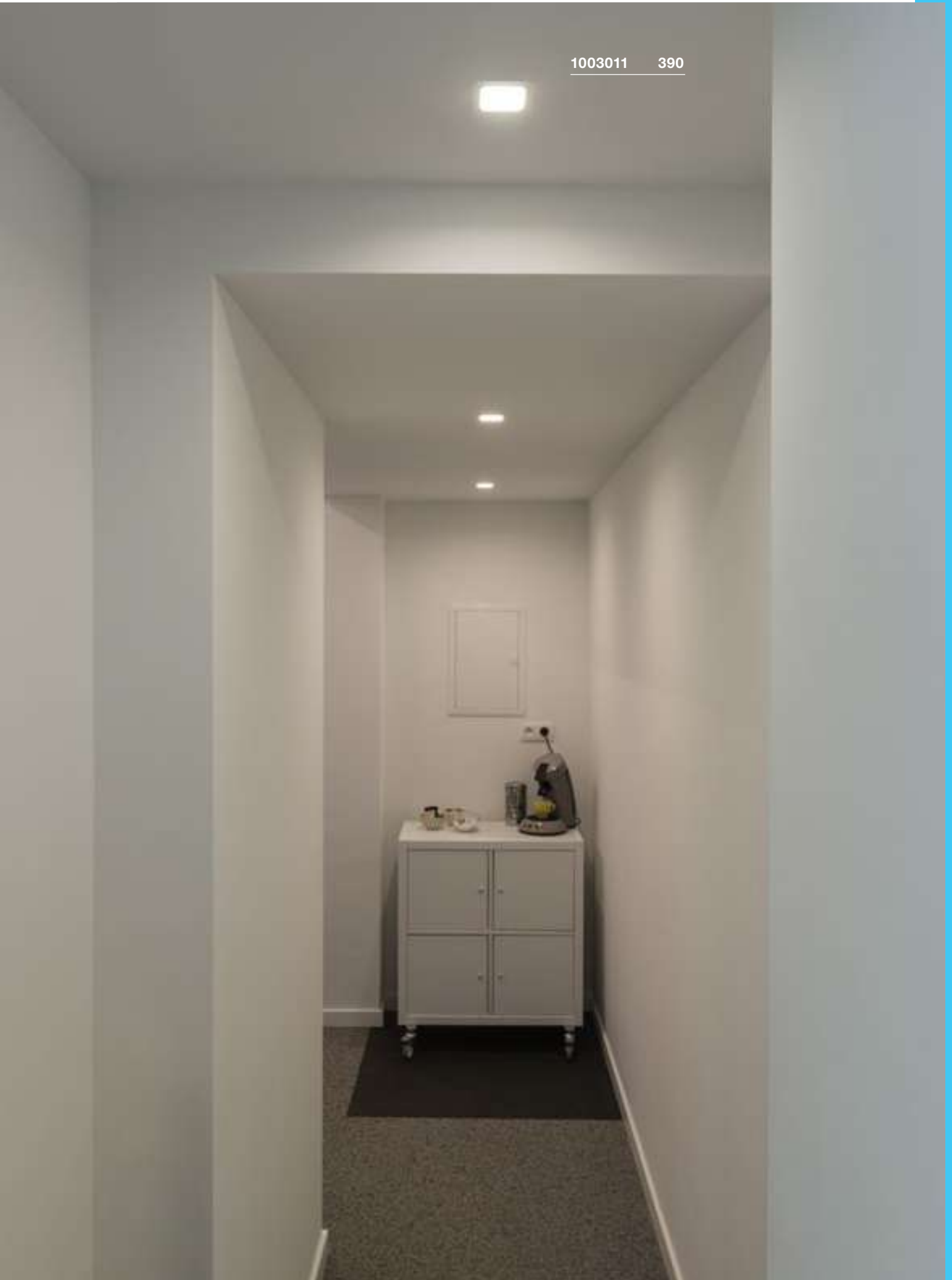

112682 393



112702 393



VERLUX
EL, quadratisch, PHASE

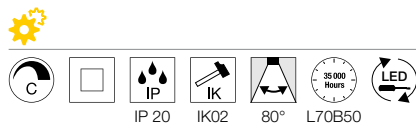
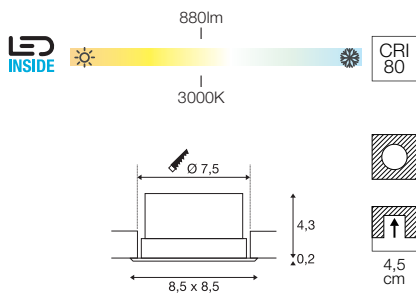

220-240V ~50/60Hz | 500mA
Systemleistung: 12W
Material: Aluminium / Kunststoff

- Clipfedern
- Materialstärke Einbaufäche: 30 mm max.

112682	880lm 3000K	

Variante	Art. Nr.
880lm 3000K CRI80	
<input type="checkbox"/> weiß	112682

VERLUX
EL, quadratisch, PHASE

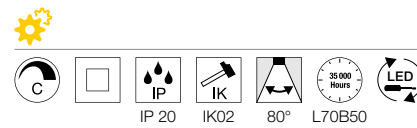
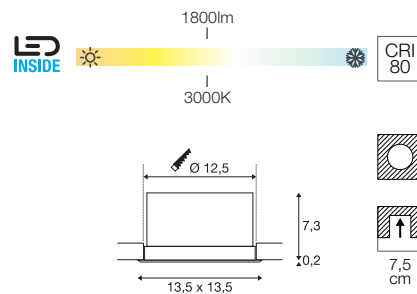

220-240V ~50/60Hz | 500mA
Systemleistung: 22W
Material: Aluminium / Kunststoff

- Clipfedern
- Materialstärke Einbaufäche: 30 mm max.

112692	1800lm 3000K	

Variante	Art. Nr.
1800lm 3000K CRI80	
<input type="checkbox"/> weiß	112692

VERLUX
EL, quadratisch, PHASE

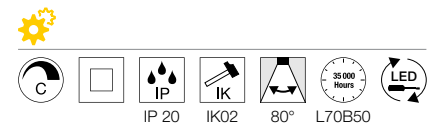
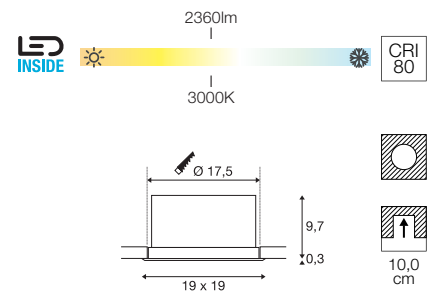

220-240V ~50/60Hz | 700mA
Systemleistung: 31W
Material: Aluminium / Kunststoff

- Clipfedern
- Materialstärke Einbaufäche: 30 mm max.

112702	2360lm 3000K	

Variante	Art. Nr.
2360lm 3000K CRI80	
<input type="checkbox"/> weiß	112702

DL 126
EL

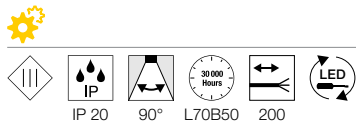
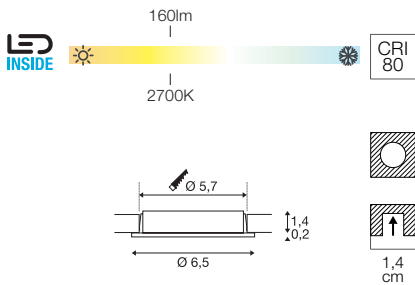

12V DC
Leistungsaufnahme: 2,8W
Material: Aluminium / Kunststoff

- Montagefedern

DL 126
EL

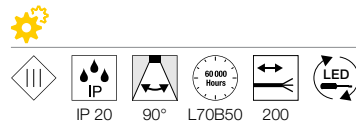
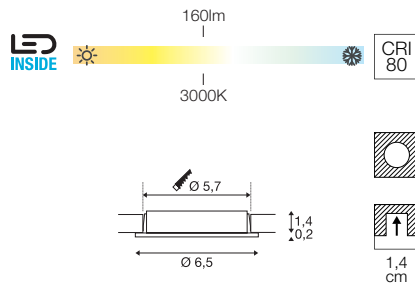
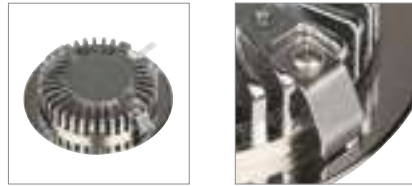

12V DC
Leistungsaufnahme: 2,8W
Material: Aluminium / Kunststoff

- Montagefedern

112161, 112165, 112162	160lm 2700K	

112221, 112225, 112222	160lm 3000K	

Variante	Art. Nr.
160lm 2700K CRI80	
weiß	112161
160lm 2700K CRI80	
grau	112165
160lm 2700K CRI80	
chrom	112162

Variante	Art. Nr.
160lm 3000K CRI80	
weiß	112221
160lm 3000K CRI80	
grau	112225
160lm 3000K CRI80	
chrom	112222

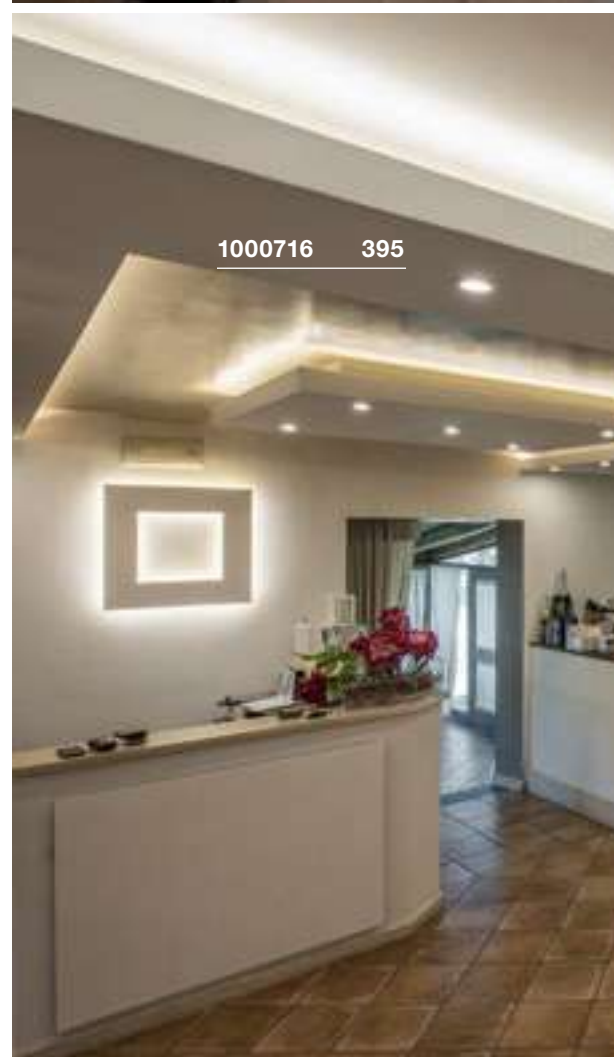



1000714 395



PIKA
DL, rund, QPAR51, starr

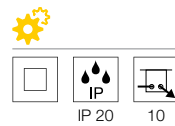
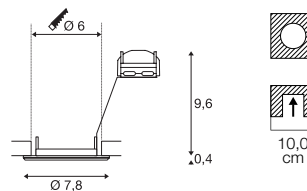

220-240V ~50/60Hz
Material: Aluminium

- Clipfedern
- Materialstärke Einbaufäche: 13 mm max.

GU10 <math><50\text{ W}</math>

LED GU10 | 6W | 38°
2700K | 450lm | EEK=G
6kWh/1000h

Art. Nr. 1005077

Variante	Art. Nr.
1xGU10	
weiß	1000714
1xGU10	
grau	1000717
1xGU10	
chrom	1000715
1xGU10	
messing	1000716

PIKA
DL, rund, QPAR51, schwenkbar

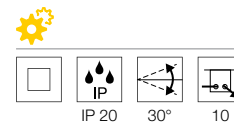
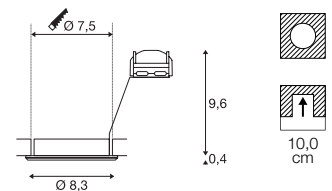

220-240V ~50/60Hz
Material: Aluminium

- Clipfedern
- Materialstärke Einbaufäche: 15 mm max.

GU10 <math><50\text{ W}</math>

LED GU10 51mm | 6W | 38°
2700K | 450lm | EEK=G
6kWh/1000h

Art. Nr. 1005075

Variante	Art. Nr.
1xGU10	
weiß	1000718
1xGU10	
grau	1000721
1xGU10	
chrom	1000719
1xGU10	
messing	1000720

OCULUS
CL, Move, PHASE

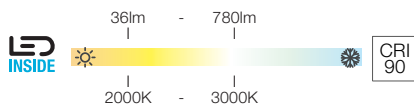

CRI 90

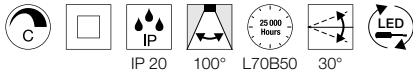
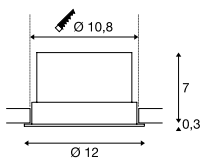

220-240V ~50/60Hz | 250mA
Systemleistung: 11W
Material: Aluminium / Glas

- Montagefedern
- Materialstärke Einbaufäche: 7-20 mm
- Additionelle gefrostete Linse inklusive



1004668, 1004669	36-780lm 2000-3000K	

Variante	Art. Nr.
36-780lm 2000-3000K CRI90	
■ schwarz	1004668
36-780lm 2000-3000K CRI90	
□ weiß	1004669

1004668 396





117331 397



117311 397

OCCULDAS 14
EL, indirekt, PHASE



OCCULDAS 23
EL, indirekt, PHASE

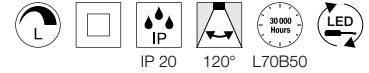
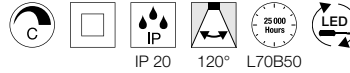
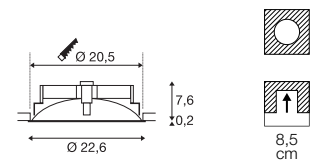
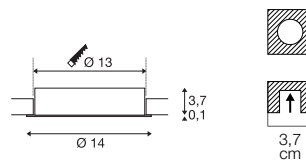
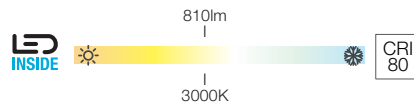

220-240V ~50/60Hz | 350mA
Systemleistung: 15W
Material: Aluminium / Stahl

200-240V ~50/60Hz | 700mA
Systemleistung: 26W
Material: Aluminium / Stahl

- Montagefedern
- Materialstärke Einbaufäche: 10-30 mm max.

- Montagefedern
- Materialstärke Einbaufäche: 10-30 mm max.



117331	810lm 3000K	



117311	1500lm 3000K	

Variante	Art. Nr.
810lm 3000K CRI80 □ weiß	117331

Variante	Art. Nr.
1500lm 3000K CRI80 □ weiß	117311

CONTONE®
DL, rund, verstellbar, PHASE

CONTONE®
DL, rund, starr, PHASE

161271 398

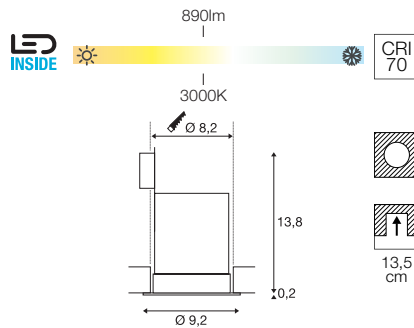
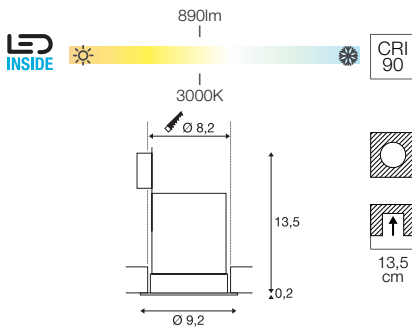
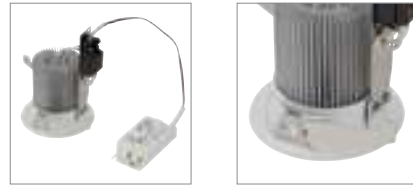
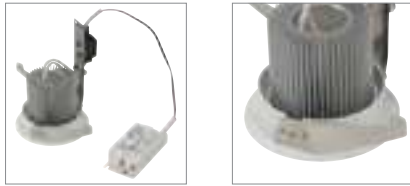

220-240V ~50/60Hz | 350mA
Systemleistung: 16W
Material: Aluminium

- Materialstärke Einbaufäche: 25 mm max.

220-240V ~50/60Hz | 350mA
Systemleistung: 16W
Material: Aluminium

- Materialstärke Einbaufäche: 25 mm max.

161271	890lm 3000K	

161291	890lm 3000K	

Variante	Art. Nr.
890lm 3000K CRI90 □ weiß	161271

Variante	Art. Nr.
890lm 3000K CRI70 □ weiß	161291



161291 398



114481 399



114490 399

H-LIGHT
DL, rund, PHASE

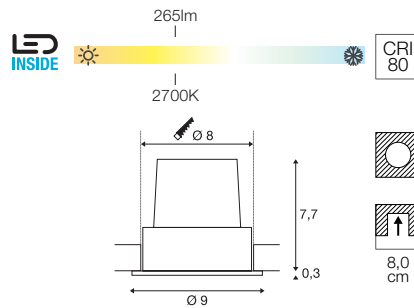

220-240V ~50/60Hz | 500mA
Systemleistung: 11W
Material: Aluminium

- Clipfedern
- Materialstärke Einbaufäche: 30 mm max.

114480, 114481	265lm 2700K	

Variante	Art. Nr.
265lm 2700K CRI80	
■ schwarz	114480
265lm 2700K CRI80	
□ weiß	114481

H-LIGHT
DL, oval, PHASE

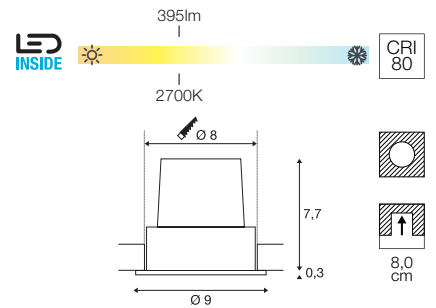

220-240V ~50/60Hz | 500mA
Systemleistung: 11W
Material: Aluminium

- Clipfedern
- Materialstärke Einbaufäche: 30 mm max.

114490, 114491	395lm 2700K	

Variante	Art. Nr.
395lm 2700K CRI80	
■ schwarz	114490
395lm 2700K CRI80	
□ weiß	114491

KARPO 30 EL



HELIA EL

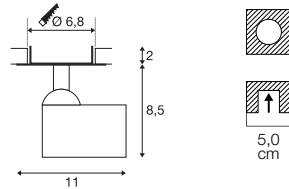
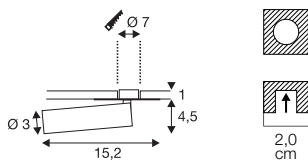
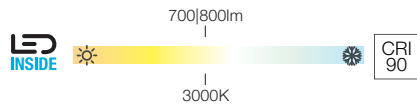
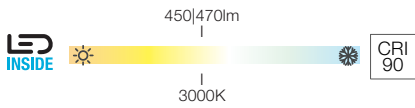
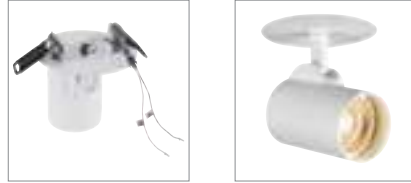
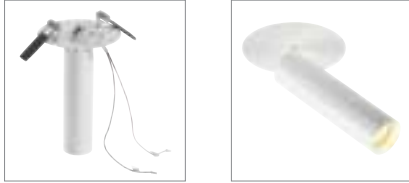

500mA
Leistungsaufnahme: 7,5W
Material: Aluminium / Stahl

500mA
Leistungsaufnahme: 9W
Material: Aluminium

- Clipfedern
- Materialstärke Einbaufäche: 12 mm max.
- Treiber exkl.

- Clipfedern
- Materialstärke Einbaufäche: 15 mm
- Treiber exkl.

152380, 152381	450lm 470lm 3000K	

156530, 156531	700lm 800lm 3000K	

Variante	Art. Nr.
450lm 3000K CRI90	
■ schwarz	152380
470lm 3000K CRI90	
□ weiß	152381

Variante	Art. Nr.
700lm 3000K CRI90	
■ schwarz	156530
800lm 3000K CRI90	
□ weiß	156531





1001156 401

LIGHTPOINT
EL

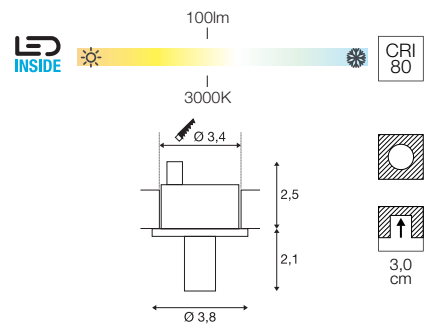

350mA
Leistungsaufnahme: 1W
Material: Aluminium / Polymethylacrylat (PMMA)

- Treiber inkl.



1001156, 1001155	100lm 3000K	



- Steckerleiste 3 Ausgänge
Art. Nr. 111850
- LED Treiber 3W | 350mA |
inkl. Zugentlastung
Art. Nr. 464107

Variante	Art. Nr.
100lm 3000K CRI80 □ weiß	1001156
100lm 3000K CRI90 ■ chrom	1001155

PLASTRA

RL, rund, QPAR51

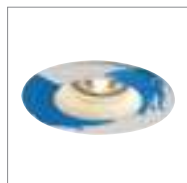

SOCKET INSIDE <35 W

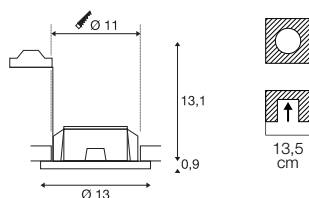

220-240V ~50/60Hz
Material: Gips / Stahl

- Clipfedern und Montageblech
- Materialstärke Einbaulfläche: 25 mm max.



GU10 <35W



LED GU10 51mm | 4W | 36°
3000K | 280lm | EEC=F
4kWh/1000h



Art. Nr. 1004973

Variante	Art. Nr.
1xGU10 <input type="checkbox"/> weiß	148070

148070 402



**148071** **403****PLASTRA**
RL, quadratisch, QPAR51**SOCKET
INSIDE**

DEKLED
EL

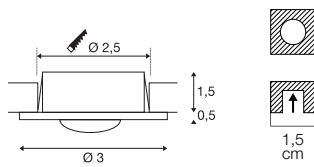
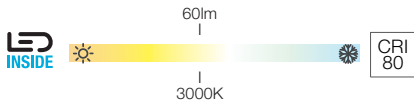

LED INSIDE

350mA
Material: Aluminium / Polycarbonat (PC)

- Clipfedern
- Materialstärke Einbaufäche: 10 mm

112242	60lm 3000K	

+

□ LED Treiber 320mA | 3W inkl. Zugentlastung
Art. Nr. 464108

Variante	Art. Nr.
60lm 3000K CRI80	
■ aluminium	112242

VARU
EL, QPAR51



SOCKET INSIDE

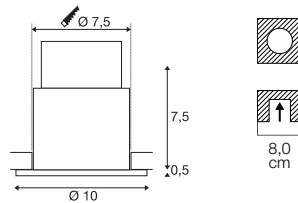

SOCKET INSIDE

220-240V ~50/60Hz
Material: Aluminium / Glas

- Clipfedern
- Materialstärke Einbaufäche: 15 mm

GU10 <5W	Ø: 5 cm	

+

LED GU10 51mm | 4W | 36°
2700K | 270lm | EEK=G
4kWh/1000h

Art. Nr. 1004972

Variante	Art. Nr.
1xGU10	
■ schwarz	1001930
1xGU10	
■ weiß / schwarz	1001931

112242 404



1001931 404





1001166 405



1001172 405

DOLIX OUT
EL, rund, QPAR51

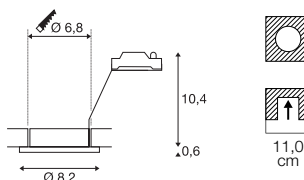

DOLIX OUT
EL, quadratisch, QPAR51

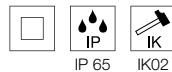
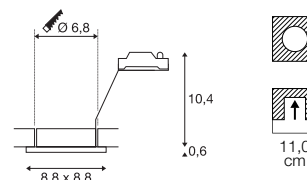

220-240V ~50/60Hz
Material: Aluminium / Glas

- Clipfedern
- Materialstärke Einbaufäche: 20 mm max.

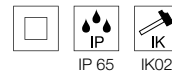

220-240V ~50/60Hz
Material: Aluminium / Glas

- Clipfedern
- Materialstärke Einbaufäche: 20 mm max.



GU10 <50W



LED GU10 51mm | 4W | 36°
3000K | 270lm | EEK=G
4kWh/1000h

Art. Nr. 1004973



GU10 <50W



LED GU10 | 6W | 36°
2700K | 900lm | EEK=G
6kWh/1000h

Art. Nr. 1005273

Variante	Art. Nr.
1xGU10	
□ weiß	1001165
■ chrom	1001166
■ grau	1001167
■ silber	1001168

Variante	Art. Nr.
1xGU10	
□ weiß	1001169
■ chrom	1001170
■ grau	1001171
■ silber	1001172

KAMUELA ECO
EL, rund, PHASE

KAMUELA ECO
EL, rund, PHASE

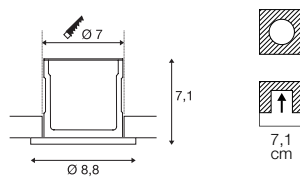
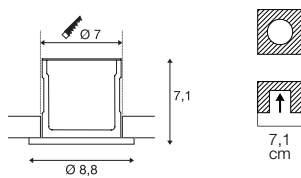
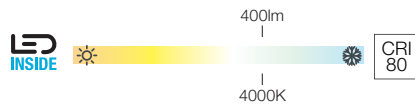
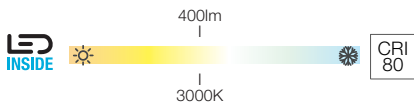

220-240V ~50Hz
Systemleistung: 6,5W
Material: Aluminium / Kunststoff

220-240V ~50Hz
Systemleistung: 6,5W
Material: Aluminium / Kunststoff

- Clipfedern
- Materialstärke Einbaufäche: 40 mm max.
- Feuerbeständig für mind. 90 Minuten nach BS 476-21

- Clipfedern
- Materialstärke Einbaufäche: 40 mm max.
- Feuerbeständig für mind. 90 Minuten nach BS 476-21

1001015, 1001016	400lm 3000K	

1001017, 1001018	400lm 4000K	

Variante	Art. Nr.
400lm 3000K CRI80	
■ schwarz	1001015
400lm 3000K CRI80	
□ weiß	1001016

Variante	Art. Nr.
400lm 4000K CRI80	
■ schwarz	1001017
400lm 4000K CRI80	
□ weiß	1001018

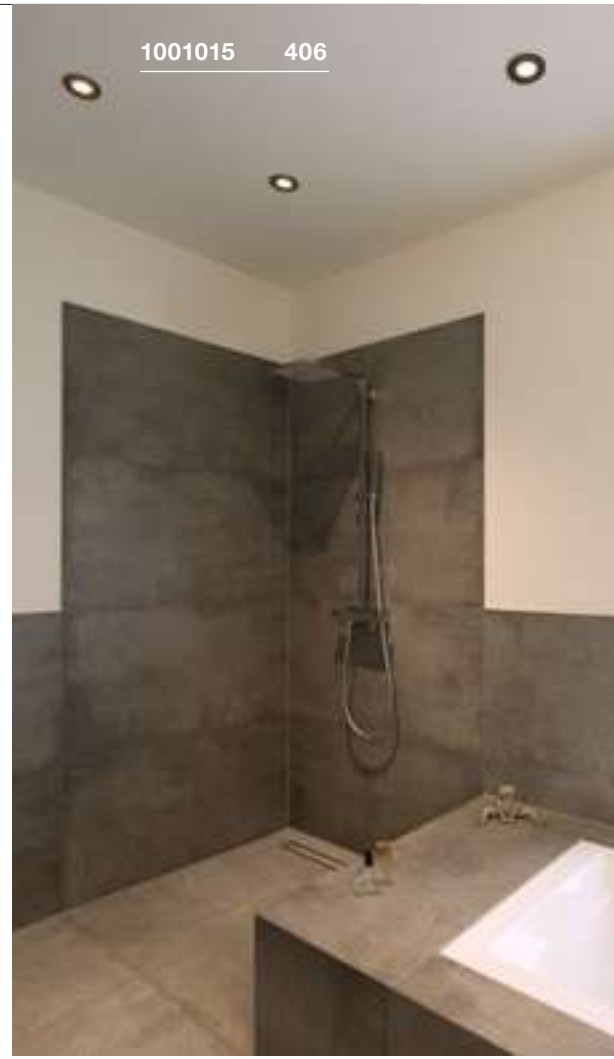

1001015 406



1001017 406



1001264 407

KINI
EL, PHASE

AKALO D83
EL, PHASE

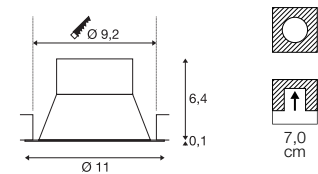
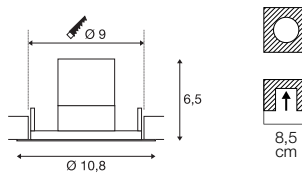
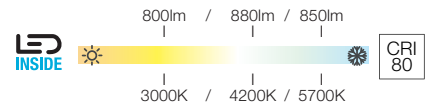
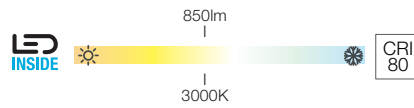
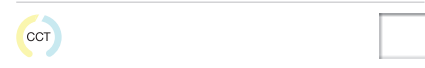

220-240V ~50/60Hz | 260mA
Systemleistung: 12W
Material: Aluminium / Polycarbonat (PC)

220-240V ~50/60Hz | 120mA
Systemleistung: 9W
Material: Aluminium / Polycarbonat (PC)

- Clipfedern
- Materialstärke Einbaufäche: 5 - 20 mm

- Clipfedern
- Materialstärke Einbaufäche: 20 mm
- Kelvinwert einstellbar durch rückwärtigen Schalter

		A → G
1000833	850lm 3000K	A → E

		A → G
1001264	800/880/850lm 3000/4200/5700K	A → F

Variante	Art. Nr.
850lm 3000K CRI80	
<input type="checkbox"/> weiß	1000833

Variante	Art. Nr.
800/880/850lm 3000/4200/5700K CRI80	
<input type="checkbox"/> weiß	1001264

FRAME BASIC SET RL

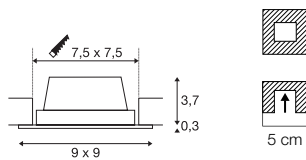
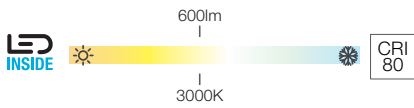

220-240V ~50/60Hz | 350mA
Systemleistung: 8,3W
Material: Aluminium / Acryl

- Clipfedern
- Materialstärke Einbaufäche: 20 mm max.

FRAME CURVE EL, HV

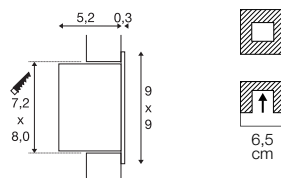
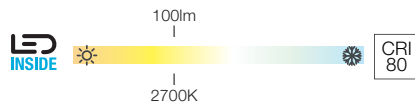

100-277V ~50/60Hz | 350mA
Systemleistung: 3,1W
Material: Aluminium

- Clipfedern
- Materialstärke Einbaufäche: 10-30 mm

1000574, 1000575	100lm 2700K	

-
- Unterputzrahmen
Art. Nr. 112780
 - Einbaudose
Art. Nr. 112781

112720, 112721	445lm 3000K	

Variante	Art. Nr.
445lm 3000K CRI80 ■ schwarz	112720
445lm 3000K CRI80 □ weiß	112721

FRAME CURVE EL

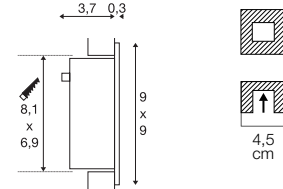
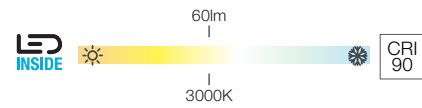
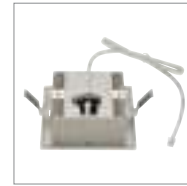

350mA
Systemleistung: 1W
Material: Aluminium

- Clipfedern
- Materialstärke Einbaufäche: 10-30 mm max.
- AMP Stecker inkl. / Treiber exkl.

113292, 111292	60lm 3000K	

-
- Steckerleiste 3 Ausgänge
Art. Nr. 111850
 - Kabelverlängerung, 1m
Art. Nr. 111861
 - Unterputzrahmen
Art. Nr. 112780
 - Einbaudose
Art. Nr. 112781
 - LED Treiber 350mA | 3W
inkl. Zugentlastung
Art. Nr. 464107

Variante	Art. Nr.
60lm 3000K CRI90 □ weiß	113292
60lm 3000K CRI90 ■ grau	111292

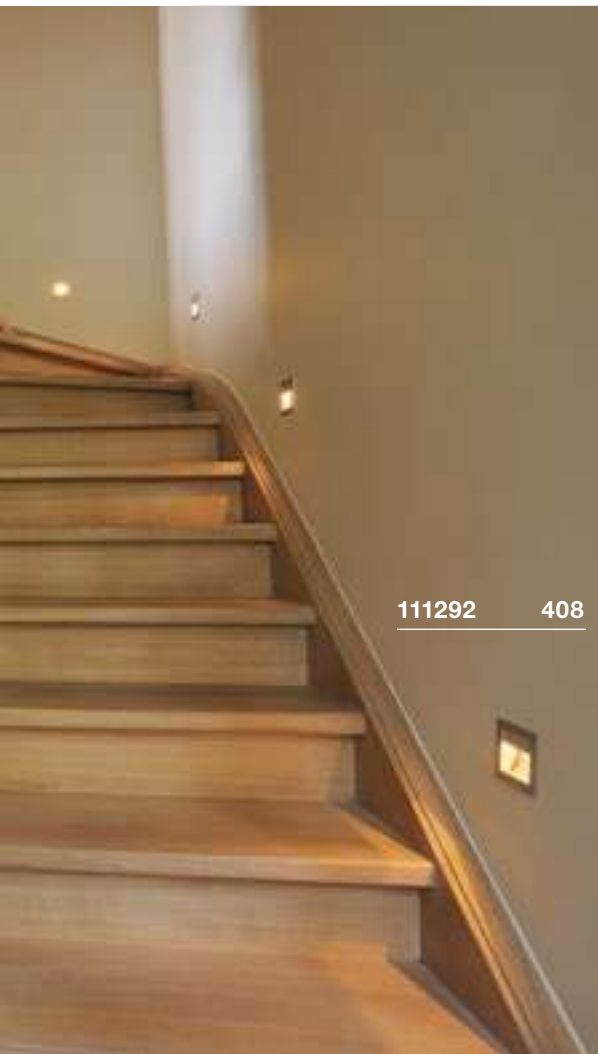

111292 408

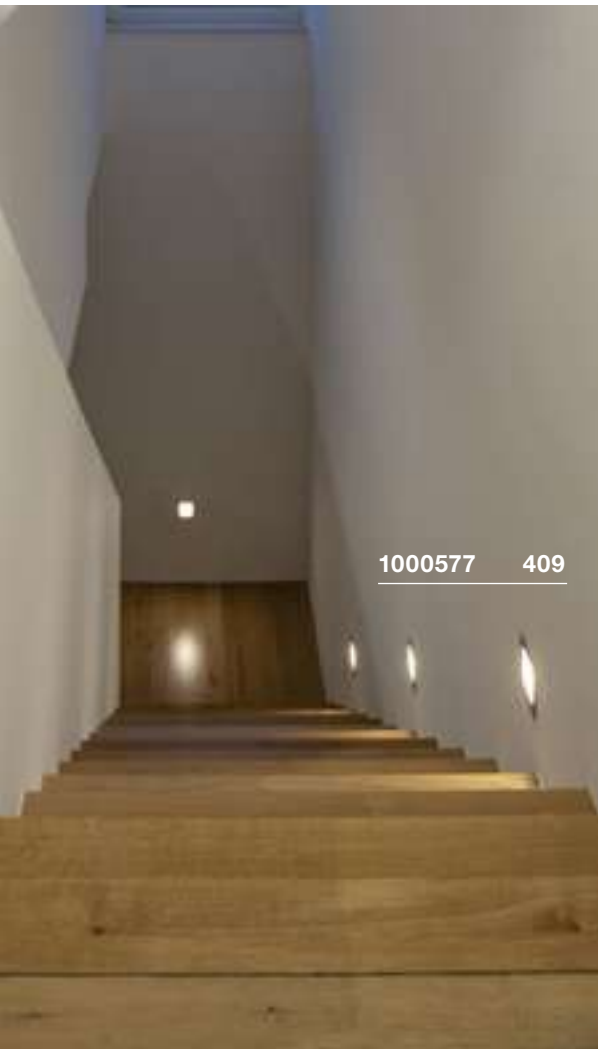

1000577 409

FRAME BASIC RL, HV

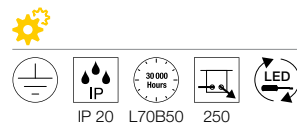
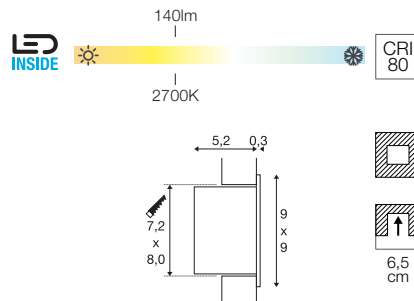

100-277V ~50/60Hz | 350mA
Systemleistung: 3,1W
Material: Aluminium

- Clipfedern
- Materialstärke Einbaufäche: 10-30 mm

1000576, 1000577	140lm 2700K	

- Unterputzrahmen
Art. Nr. 112780
- Einbaudose
Art. Nr. 112781

Variante	Art. Nr.
140lm 2700K CRI80 <input type="checkbox"/> weiß	1000576
140lm 2700K CRI90 <input type="checkbox"/> grau	1000577

FRAME BASIC RL

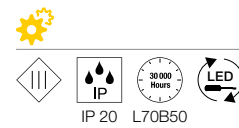
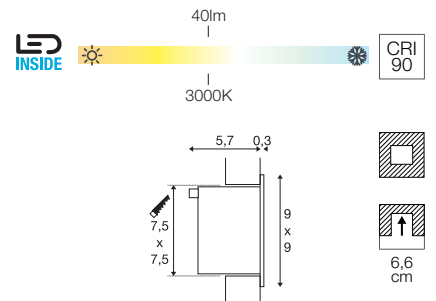

350mA
Systemleistung: 1W
Material: Aluminium / Glas

- Clipfedern
- Materialstärke Einbaufäche: 10-30 mm max.
- AMP Stecker inkl. / Treiber exkl.

113262, 111262	40lm 3000K	

- Steckerleiste 3 Ausgänge
Art. Nr. 111850
- Kabelverlängerung, 1m
Art. Nr. 111861
- Unterputzrahmen
Art. Nr. 112780
- Einbaudose
Art. Nr. 112781
- LED Treiber 350mA | 3W
inkl. Zugentlastung
Art. Nr. 464107

Variante	Art. Nr.
40lm 3000K CRI90 <input type="checkbox"/> weiß	113262
40lm 3000K CRI90 <input type="checkbox"/> grau	111262

QUAD FRAME 9
WL

NOTAPO S
RL

NOTAPO L
RL

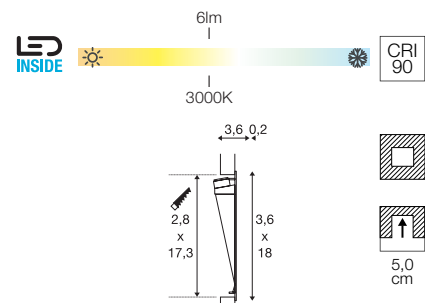
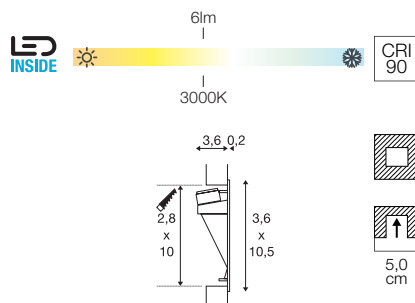
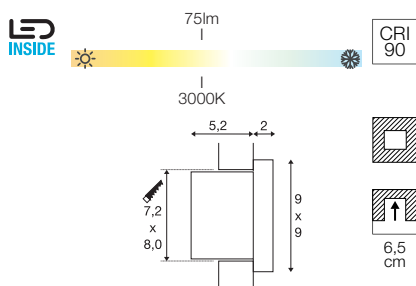
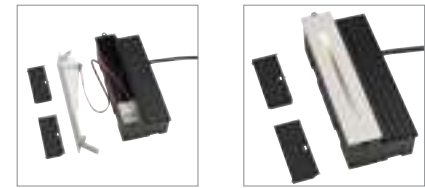
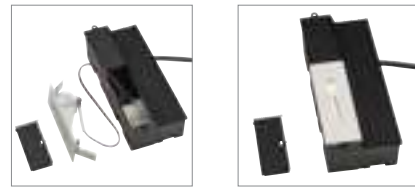
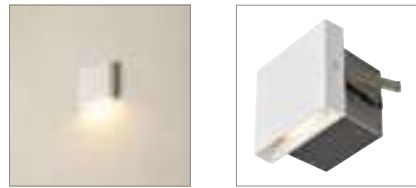

100-240V ~50/60Hz | 350mA
Systemleistung: 3W
Material: Aluminium / Aluminium

700mA
Systemleistung: 2W
Material: Aluminium

700mA
Systemleistung: 2W
Material: Aluminium

- Clipfedern
- Materialstärke Einbaufäche: 10-30 mm

- Clipfedern
- Offenes Kabelende

- Clipfedern
- Offenes Kabelende

1003466	75lm 3000K	

1002979	6lm 3000K	

1002980	6lm 3000K	

- +**
- Unterputzrahmen
Art. Nr. 112780
 - Einbaudose
Art. Nr. 112781

- +**
- LED Treiber 700mA | 10,5W dimmbar inkl Zugentlastung
Art. Nr. 464142
 - LED Treiber 700mA | 3W inkl. Zugentlastung
Art. Nr. 464200
 - NOTAPO | Einbaurahmen
Art. Nr. 1002981

- +**
- LED Treiber 700mA | 10,5W dimmbar inkl Zugentlastung
Art. Nr. 464142
 - LED Treiber 700mA | 3W inkl. Zugentlastung
Art. Nr. 464200
 - NOTAPO | Einbaurahmen
Art. Nr. 1002981

Variante	Art. Nr.
75lm 3000K CRI90 □ weiß	1003466

Variante	Art. Nr.
6lm 3000K CRI90 H: 10,5 cm □ weiß	1002979

Variante	Art. Nr.
6lm 3000K CRI90 H: 18 cm □ weiß	1002980



1003466 410

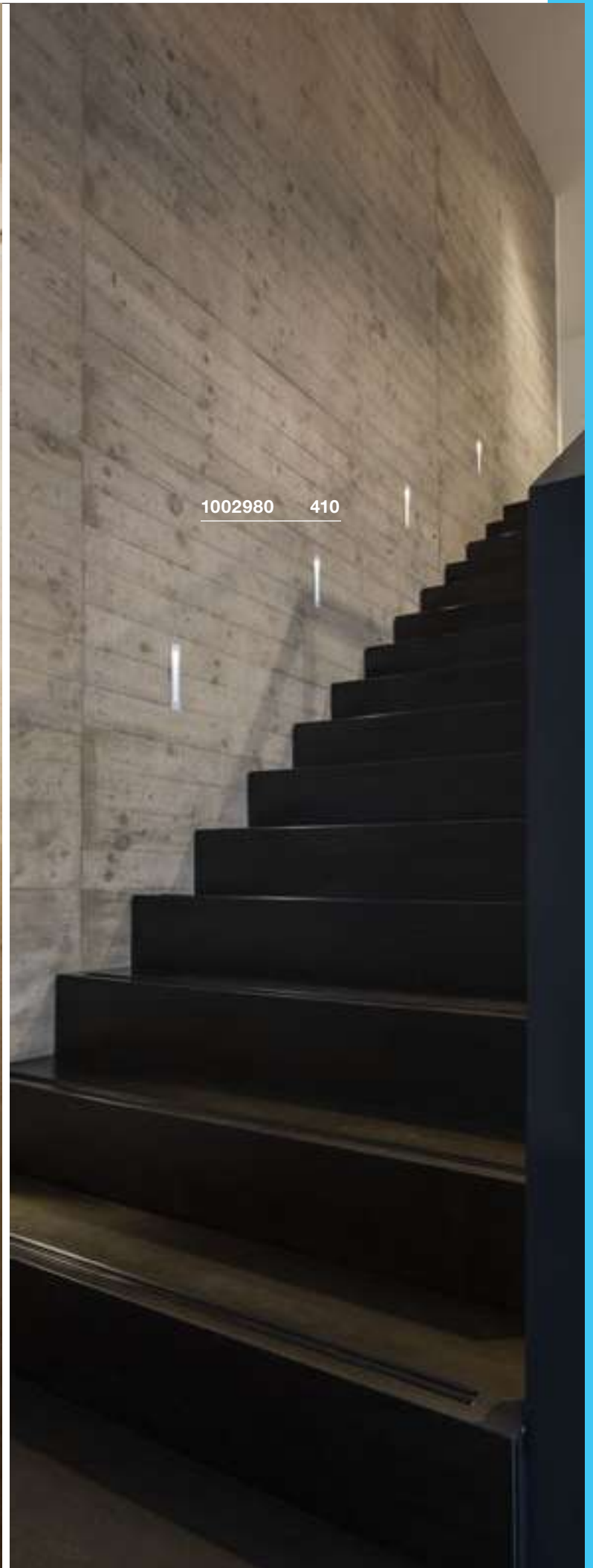

1002980 410

DOWNUNDER PUR 80 EL

DOWNUNDER PUR 150 EL

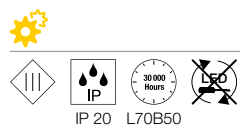
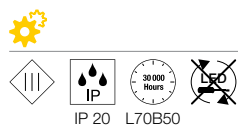
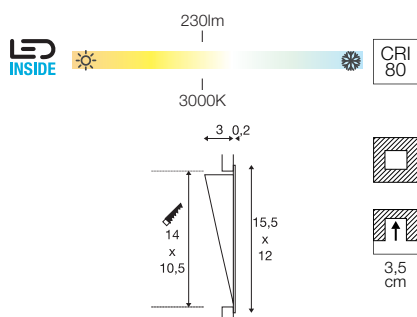
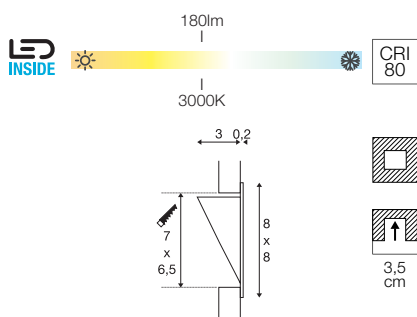

350mA
Systemleistung: 3,6W
Material: Aluminium / Stahl

500mA
Systemleistung: 5,2W
Material: Aluminium / Stahl

- Montagefedern
- Materialstärke Einbaufäche: 15 mm max.

- Montagefedern
- Materialstärke Einbaufäche: 15 mm max.

151950	180lm 3000K	

151952	230lm 3000K	

- +**
- Einbaurahmen
Art. Nr. **151960**
 - LED Treiber 350mA | 10W
Art. Nr. **464140**

- +**
- Einbaurahmen
Art. Nr. **151962**
 - LED Treiber 500mA | 15W dimmbar
Art. Nr. **464144**

Variante	Art. Nr.
180lm 3000K CRI80 □ weiß	151950

Variante	Art. Nr.
230lm 3000K CRI80 □ weiß	151952

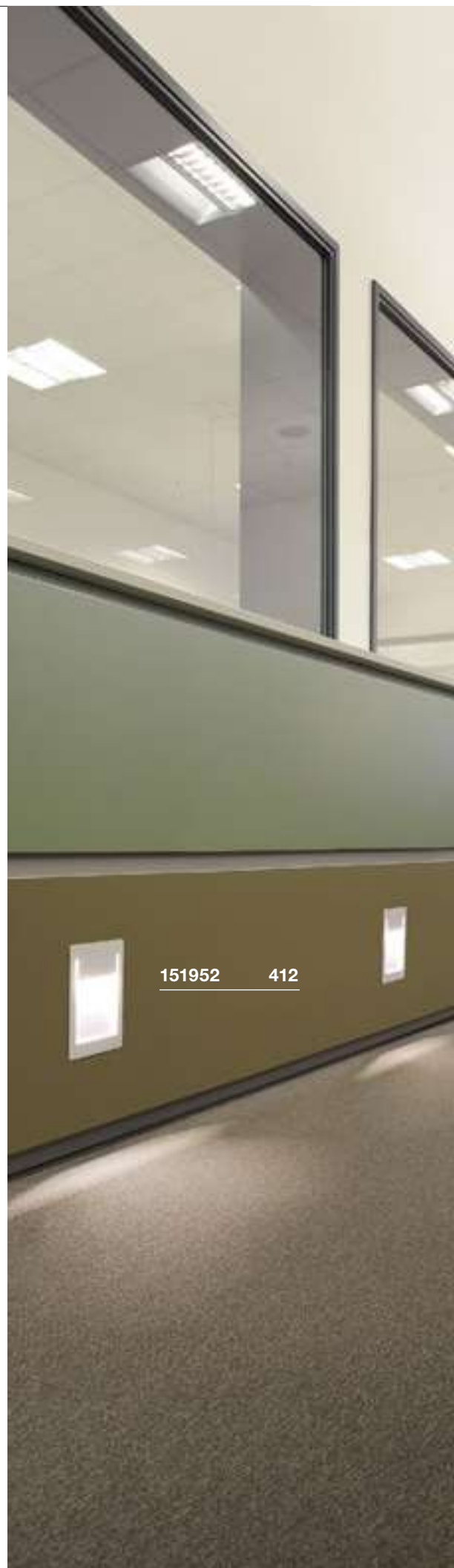

151952 412



1002982 413

MOBALA
EL

WORD
EL

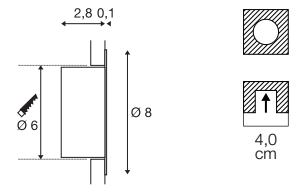
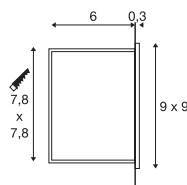
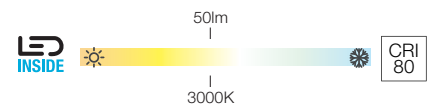
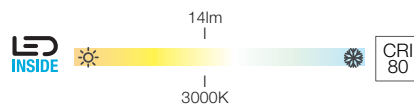

IP 20 L70B50

IP 20 L70B50 35

100-240V ~50/60Hz | 24V
Systemleistung: 1,3W
Material: Aluminium

350mA
Systemleistung: 1,2W
Material: Stahl

- Der Artikel ist für die Installation in Hohlwand- und Unterputzdosen für Schalter/Steckdosen geeignet.
- Offenes Kabelende

1002982	14lm 3000K	

1002922	50lm 3000K	

-
- MOBALA | Einbaudose
Art. Nr. 1002983
 - MOBALA | Einbaurahmen
Art. Nr. 1002984

-
- LED Treiber 320mA | 3W
inkl. Zugentlastung
Art. Nr. 464108

Variante	Art. Nr.
14lm 3000K CRI80 □ weiß	1002982

Variante	Art. Nr.
50lm 3000K CRI80 □ weiß	1002922

MEDO 30
EL, Rahmenlos

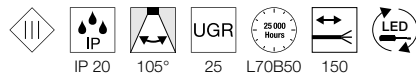
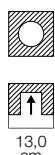
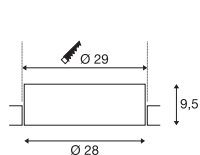
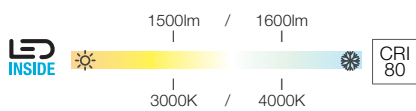

350mA
Systemleistung: 14W
Material: Aluminium / Polymethylacrylat (PMMA)

- Offenes Kabelende



1001901	1500/1600lm 3000/4000K	



LED Treiber 20W | 350mA | 1-10V/
DALI dimmbar | inkl. Zugentlastung
Art. Nr. 1002423



Variante	Art. Nr.
1500/1600lm 3000/4000K CRI80	
<input type="checkbox"/> weiß	1001901



MEDO 40
EL, Rahmenlos

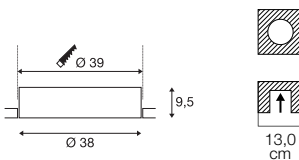
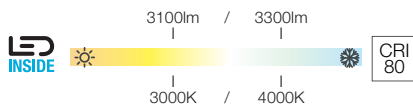

700mA
Systemleistung: 28W
Material: Aluminium / Polymethylacrylat (PMMA)

- Offenes Kabelende



1001902	3100/3300lm 3000/4000K	



- LED Treiber 40W | 700/900/1000mA inkl. Zugentlastung
Art. Nr. 1006120
- LED Treiber 40W | 700mA | dimmbar
Art. Nr. 1005446
- LED Treiber 40W | 700mA | 1-10V/ DALI dimmbar | inkl. Zugentlastung
Art. Nr. 1002424

Variante	Art. Nr.
3100/3300lm 3000/4000K CRI80	
<input type="checkbox"/> weiß	1001902

MEDO 60
EL, Rahmenlos

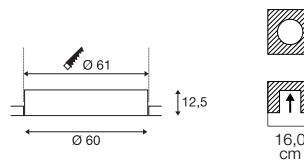

1000/1050mA
Systemleistung: 36W
Material: Aluminium / Polymethylacrylat (PMMA)

- Offenes Kabelende



1001903	4700/5000lm 3000/4000K	



- LED Treiber 40W | 700/900/1000mA inkl. Zugentlastung
Art. Nr. 1006120
- LED Treiber 40W | 700mA | dimmbar
Art. Nr. 1005446
- LED Treiber 40W | 700mA | 1-10V/ DALI dimmbar | inkl. Zugentlastung
Art. Nr. 1002424

Variante	Art. Nr.
4700/5000lm 3000/4000K CRI80	
<input type="checkbox"/> weiß	1001903

MEDO 90
EL, Rahmenlos

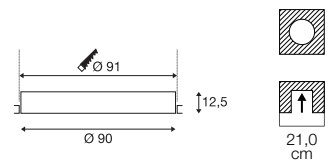
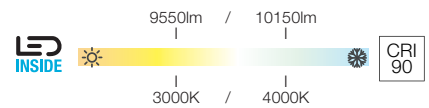
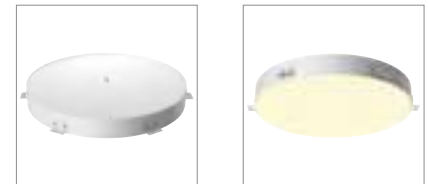

1000/1050mA
Systemleistung: 72W
Material: Aluminium / Polymethylacrylat (PMMA)

- es werden 2 Treiber benötigt
- Offenes Kabelende



1001904	9550/10150lm 3000/4000K	



- LED Treiber 40W | 700/900/1000mA inkl. Zugentlastung
Art. Nr. 1006120
- LED Treiber 40W | 700mA | dimmbar
Art. Nr. 1005446
- LED Treiber 40W | 700mA | 1-10V/ DALI dimmbar | inkl. Zugentlastung
Art. Nr. 1002424

Variante	Art. Nr.
9550/10150lm 3000/4000K CRI90	
<input type="checkbox"/> weiß	1001904

MEDO 30
EL, Einbaurahmen

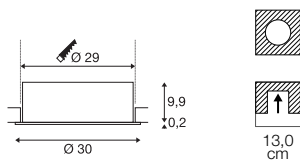
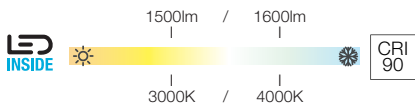

IP 20 105° 25 L70B50 150

350mA
Systemleistung: 14W
Material: Aluminium / Polymethylacrylat (PMMA)

- Offenes Kabelende

MEDO 40
EL, Einbaurahmen

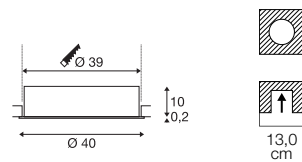
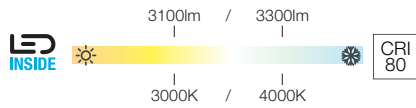

IP 20 105° 25 L70B50 150

700mA
Systemleistung: 28W
Material: Aluminium / Polymethylacrylat (PMMA)

- Offenes Kabelende

MEDO 60
EL, Einbaurahmen

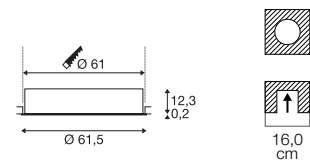
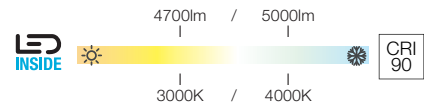

IP 20 105° 25 L70B50 150

1000/1050mA
Systemleistung: 36W
Material: Aluminium / Polymethylacrylat (PMMA)

- Offenes Kabelende

1001905	1500/1600lm 3000/4000K	

1001906	3100/3300lm 3000/4000K	

1001907	4700/5000lm 3000/4000K	

LED Treiber 20W | 350mA | 1-10V/
DALI dimmbar | inkl. Zugentlastung
Art. Nr. 1002423

LED Treiber 40W | 700/900/1000mA
inkl. Zugentlastung
Art. Nr. 1006120

LED Treiber 40W | 700mA |
dimmbar
Art. Nr. 1005446

LED Treiber 40W | 700mA | 1-10V/
DALI dimmbar | inkl. Zugentlastung
Art. Nr. 1002424

LED Treiber 40W | 700/900/1000mA
inkl. Zugentlastung
Art. Nr. 1006120

LED Treiber 40W | 700mA |
dimmbar
Art. Nr. 1005446

LED Treiber 40W | 700mA | 1-10V/
DALI dimmbar | inkl. Zugentlastung
Art. Nr. 1002424

Variante	Art. Nr.
1500/1600lm 3000/4000K CRI90 <input type="checkbox"/> weiß	1001905

Variante	Art. Nr.
3100/3300lm 3000/4000K CRI80 <input type="checkbox"/> weiß	1001906

Variante	Art. Nr.
4700/5000lm 3000/4000K CRI90 <input type="checkbox"/> weiß	1001907



MEDO 90
EL, Einbaurahmen

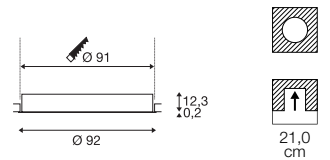
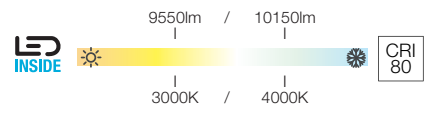

1000/1050mA
 Systemleistung: 72W
 Material: Aluminium / Polymethylacrylat (PMMA)

- es werden 2 Treiber benötigt
- Offenes Kabelende

1001908	9550/10150lm 3000/4000K	

- +**
- LED Treiber 40W | 700/900/1000mA inkl. Zugentlastung
Art. Nr. 1006120
 - LED Treiber 40W | 700mA | dimmbar
Art. Nr. 1005446
 - LED Treiber 40W | 700mA | 1-10V/ DALI dimmbar | inkl. Zugentlastung
Art. Nr. 1002424

Variante	Art. Nr.
9550/10150lm 3000/4000K CRI80	
<input type="checkbox"/> weiß	1001908

CONNECTED LED PANEL
595x595mm, UGR<19

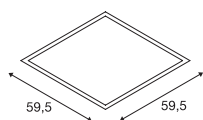
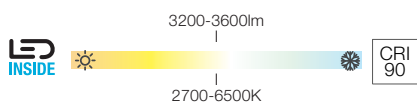

100-240V ~50/60Hz | 1050mA
Systemleistung: 43W
Material: Aluminium / Acryl

- fernsteuerbar und dimmbar mit Remote Control CCT/DIM [1002994] oder Gateway [1002411]

CONNECTED LED PANEL
620x620mm, UGR<19

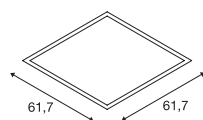
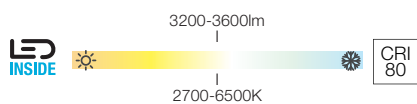

100-240V ~50/60Hz | 1050mA
Systemleistung: 43W
Material: Aluminium / Acryl

- fernsteuerbar und dimmbar mit Remote Control CCT/DIM [1002994] oder Gateway [1002411]

1001250	3200-3600lm 2700-6500K	

Variante **Art. Nr.**
3200-3600lm | 2700-6500K | CRI90
 weiß **1001250**

1001251	3200-3600lm 2700-6500K	

Variante **Art. Nr.**
3200-3600lm | 2700-6500K | CRI80
 weiß **1001251**





1003084 419

LED PANEL
600x600mm

LED PANEL
620x620mm

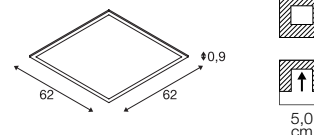
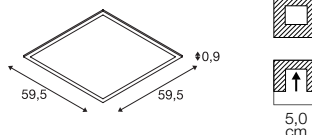
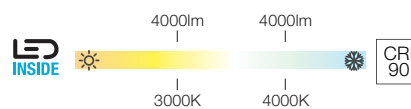
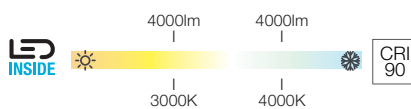

1050mA
Leistungsaufnahme: 35W
Material: Aluminium / Polystrol (PS)

1050mA
Leistungsaufnahme: 35W
Material: Aluminium / Polystrol (PS)

- Offenes Kabelende

- Offenes Kabelende

1003083, 1003084	4000lm 3000 4000K	

1003073, 1003074	4000lm 3000 4000K	

-
- LED Treiber 1050mA | 40W Triac Phasenabschnitt dimmbar
Art. Nr. 464804
 - LED Treiber 50W | 700-1400mA | 1-10V/DALI dimmbar | inkl. Zugentlastung
Art. Nr. 1002425

-
- LED Treiber 1050mA | 40W Triac Phasenabschnitt dimmbar
Art. Nr. 464804
 - LED Treiber 50W | 700-1400mA | 1-10V/DALI dimmbar | inkl. Zugentlastung
Art. Nr. 1002425

Variante	Art. Nr.
4000lm 3000K CRI90 <input type="checkbox"/> weiß	1003083
4000lm 4000K CRI90 <input type="checkbox"/> weiß	1003084

Variante	Art. Nr.
4000lm 3000K CRI90 <input type="checkbox"/> weiß	1003073
4000lm 4000K CRI90 <input type="checkbox"/> weiß	1003074

P-LIGHT
EL



PATTA-I
EL, rund, PHASE



PATTA-I
DL, eckig, PHASE

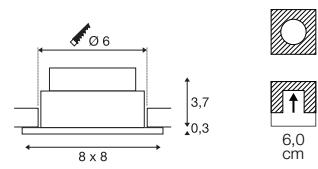
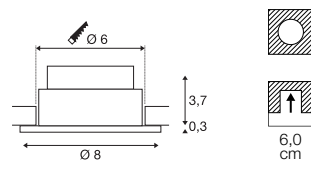
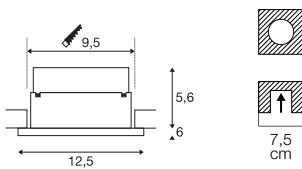
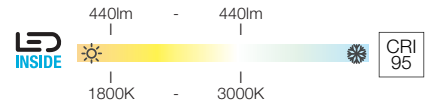
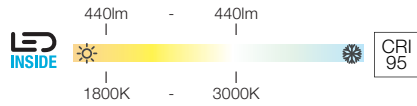

220-240V ~50Hz
Systemleistung: 5W
Material: ABS / Polycarbonat (PC)

220-240V ~50/60Hz | 350mA
Systemleistung: 7,3W
Material: Aluminium / Glas

220-240V ~50/60Hz | 350mA
Systemleistung: 7,3W
Material: Aluminium / Glas

- Clipfedern
- Materialstärke Einbaufäche: 25 mm max.
- Als Notbeleuchtung einsetzbar. Auto Test Funktion. Ni-Mh Akku 2x 3.6V 1.5Ah inklusiv. Notbetrieb über Akku 3 Std. Halbstreuwinkel 90°

- Produkte werden mit Clipfedern geliefert. Blattfedern liegen dem Produkt bei und können ausgetauscht werden.
- Materialstärke Einbaufäche: 20 mm

- Produkte werden mit Clipfedern geliefert. Blattfedern liegen dem Produkt bei und können ausgetauscht werden.
- Materialstärke Einbaufäche: 20 mm

Art. Nr. 240024

1002098, 1002099, 1002100	440lm 1800-3000K	

1002101, 1002102, 1002103	440lm 1800-3000K	

Variante	Art. Nr.
120lm 6000K CRI70	
<input type="checkbox"/> weiß	240006

Variante	Art. Nr.
440lm 1800-3000K CRI95	
<input checked="" type="checkbox"/> schwarz	1002098
440lm 1800-3000K CRI95	
<input type="checkbox"/> weiß	1002099
440lm 1800-3000K CRI95	
<input type="checkbox"/> gebürstet aluminium	1002100

Variante	Art. Nr.
440lm 1800-3000K CRI95	
<input checked="" type="checkbox"/> schwarz	1002101
440lm 1800-3000K CRI95	
<input type="checkbox"/> weiß	1002102
440lm 1800-3000K CRI95	
<input type="checkbox"/> gebürstet aluminium	1002103



240006 420

PATTA-I
EL, rund, PHASE

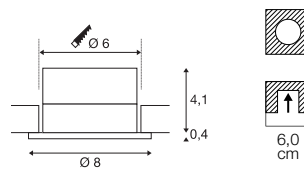
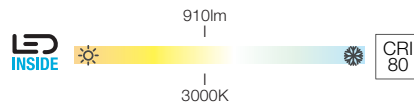

IP 20 / IP 65 38° L70B50

220-240V ~50/60Hz | 500mA
Systemleistung: 11W
Material: Aluminium / Glas

- Clipfedern
- Materialstärke Einbaufäche: 25 mm



1002102 420

PATTA-I
EL, quadratisch, PHASE

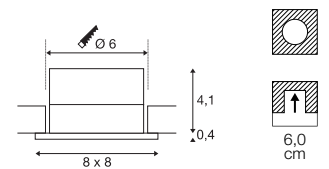
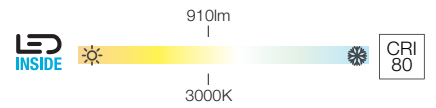
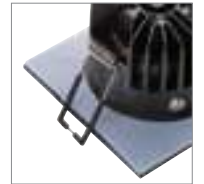

IP 20 / IP 65 38° L70B50

220-240V ~50/60Hz | 500mA
Systemleistung: 11W
Material: Aluminium / Glas

- Clipfedern
- Materialstärke Einbaufäche: 25 mm

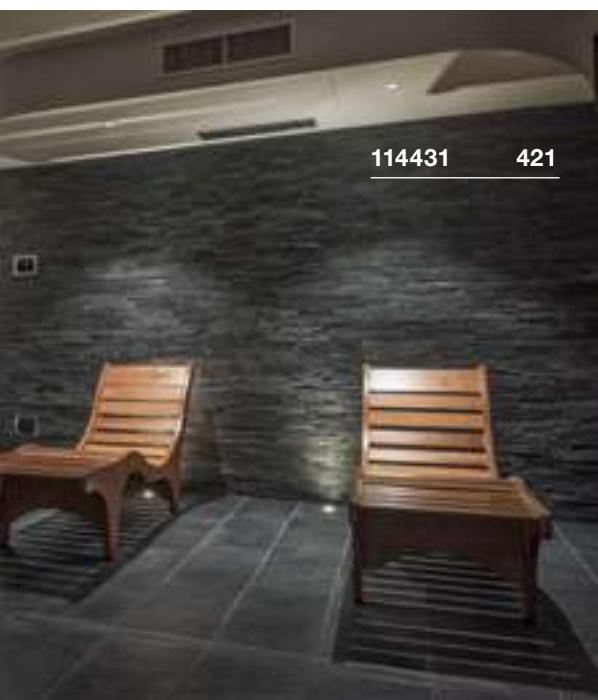

114431 421

114420, 114421, 114426	910lm 3000K	
------------------------------	----------------	--

Variante	Art. Nr.
910lm 3000K CRI80	
■ schwarz	114420
910lm 3000K CRI80	
□ weiß	114421
910lm 3000K CRI80	
■ gebürstet aluminium	114426

114430, 114431, 114436	910lm 3000K	
------------------------------	----------------	--

Variante	Art. Nr.
910lm 3000K CRI80	
■ schwarz	114430
910lm 3000K CRI80	
□ weiß	114431
910lm 3000K CRI80	
■ gebürstet aluminium	114436

PATTA-F
EL, rund, PHASE



PATTA-F
EL, quadratisch, PHASE

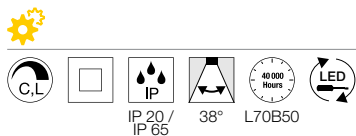
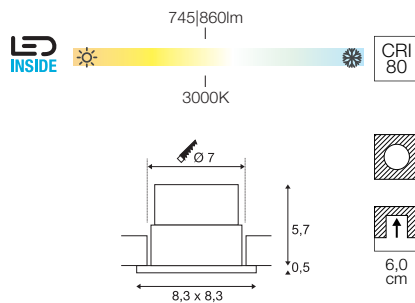
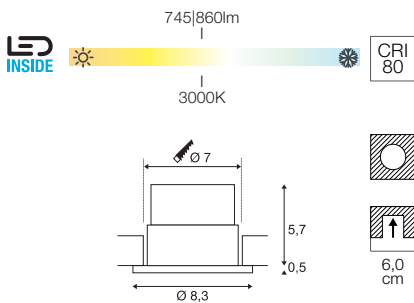

220-240V ~50/60Hz | 500mA
Systemleistung: 11W
Material: Aluminium / Glas

- Clipfedern
- Materialstärke Einbaufäche: 20 mm

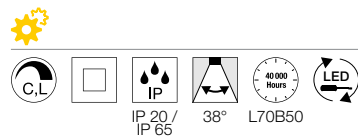

220-240V ~50/60Hz | 500mA
Systemleistung: 11W
Material: Aluminium / Glas

- Clipfedern
- Materialstärke Einbaufäche: 20 mm

114440, 114441	745lm 860lm 3000K	

114450, 114451	745lm 860lm 3000K	

Variante	Art. Nr.
745lm 3000K CRI80	
■ schwarz	114440
860lm 3000K CRI80	
□ weiß	114441

Variante	Art. Nr.
745lm 3000K CRI80	
■ schwarz	114450
860lm 3000K CRI80	
□ weiß	114451



114450 422



OUT 65
EL, rund, PHASE

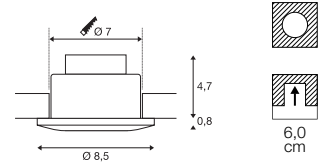
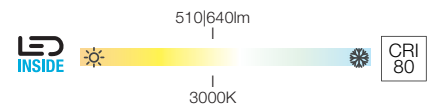

220-240V ~50/60Hz | 500mA
Systemleistung: 11W
Material: Aluminium / Glas

- Clipfedern
- Materialstärke Einbaufäche: 20 mm

114460, 114461	510lm 640lm 3000K	

Variante	Art. Nr.
510lm 3000K CRI80	
■ schwarz	114460
640lm 3000K CRI80	
□ weiß	114461

PROFESSIONELL AUFGESTELLT.

3-PHASEN-HOCHVOLT-STROMSCHIENEN FÜR NEUE LICHTAKZENTE.

Besonders dort, wo es viel zu sehen gibt, ist eine gut durchdachte Beleuchtung unerlässlich. 3-Phasen-Hochvolt-Stromschienen sind darum besonders für Shops und Messestände ideal. Sie ermöglichen eine perfekte Ausleuchtung und rücken Produkte und Ausstellungsstücke ins rechte Licht.



1001865 458



1004267 67

3-Phasen Spots aus dem NUMINOS® Down- und Spotlightsystem finden Sie auf den Seiten 62 bis 71. Oder ganz einfach online konfigurieren unter: www.numinos.slv.com



1004287 67



1006157 444

HOCHVOLT-STROMSCHIENE 3-PHASEN

NEW						NEW	NEW		
	440	441	441	443	443	444	444	444	445
							NEW		
	445	446	446	447	448	448	450	451	451
	451	452	452	453	453	453	454	454	454
	454	456	456	457	457	458	459	459	459
	459								

Passende Einbau- und Aufbauschielen sowie Zubehör finden Sie auf den Seiten 431-439





Weitere Leuchten und Varianten finden Sie online unter www.slv.com
 Herstellerangaben unserer Leuchtmittelempfehlungen finden Sie im Kapitel Leuchtmittel ab Seite 808

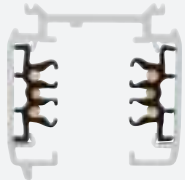

KOMPATIBILITÄT

3-Phasen Stromschienen

Kompatibel mit Leuchten/Adaptern von:

 Schienen und Schienenkomponenten S-Track DALI 	Anwendung	SLV	Global/Nordic
			
ohne DALI		✓	✓
mit DALI		✓	✓

Kompatibel mit Schienen und Schienenkomponenten von:

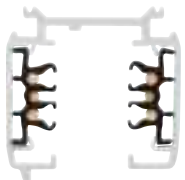
 Leuchten S-Track DALI 	Anwendung	SLV S-TRACK	Global/Nordic
			
ohne DALI		✓	✓
mit DALI		✓	✓

- ★ Vorbehaltlich vorheriger Prüfung mittels Mustern der Leuchte und der Schiene
- ★★ Jedoch ohne DALI Funktionalität

Angaben ohne Gewähr.

Technische Daten und Abmessungen können sich jederzeit ohne Vorankündigung ändern.

Bereits bei Planung des Projekts anhand Muster prüfen, um Funktionsfähigkeit sicherzustellen.

Kompatibilität bezieht sich nur auf Schienen/Leuchten.

Schienen und Schienenkomponenten verschiedener Hersteller sollten nicht kombiniert werden.

Die SLV Schienensysteme und -komponenten sind hochkompatibel.
 Mit Leuchten und Adaptern von: EUTRAC®, Zumtobel, Erco und
 LTS ONETrack. Vorbehaltlich der vorherigen Prüfung mittels Muster
 der Leuchten und Schienen.

	EUTRAC®	Zumtobel	Erco	LTS ONETrack
	★	✓	✓	✓
	✗	✓	✓	✓

	EUTRAC®	Zumtobel	Erco	LTS ONETTrack
	✓	✓	✓	✓
	✓★★	✓	✓	✓



S-TRACK

3-Phasen-Aufbauschiene DALI

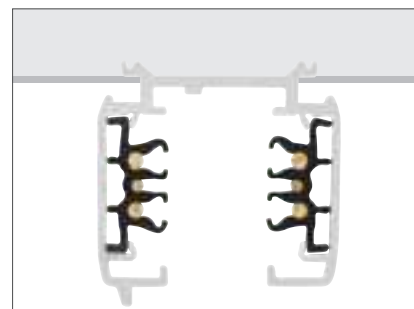

DALI

Nennspannung (V)

1 m

220-240V ~50/60Hz

1 m

220-240V ~50/60Hz

2 m

220-240V ~50/60Hz

2 m

220-240V ~50/60Hz

max. Stromstärke (A)

16

16

16

16

mech. Belastung max.

30 kg

30 kg

30 kg

30 kg

Material

Aluminium

Aluminium

Aluminium

Aluminium

Farbe

■ schwarz

□ weiß

■ schwarz

□ weiß

L x B x H (cm)

100 x 3,6 x 3,6

100 x 3,6 x 3,6

200 x 3,6 x 3,6

200 x 3,6 x 3,6

Art. Nr.

1004937

1004938

1002631

1002632

EUR



DALI

Nennspannung (V)

3 m

220-240V ~50/60Hz

3 m

220-240V ~50/60Hz

4 m

220-240V ~50/60Hz

4 m

220-240V ~50/60Hz

max. Stromstärke (A)

16

16

16

16

mech. Belastung max.

30 kg

30 kg

30 kg

30 kg

Material

Aluminium

Aluminium

Aluminium

Aluminium

Farbe

■ schwarz

□ weiß

■ schwarz

□ weiß

L x B x H (cm)

300 x 3,6 x 3,6

300 x 3,6 x 3,6

400 x 3,6 x 3,6

400 x 3,6 x 3,6

Art. Nr.

1002633

1002634

1002635

1002636









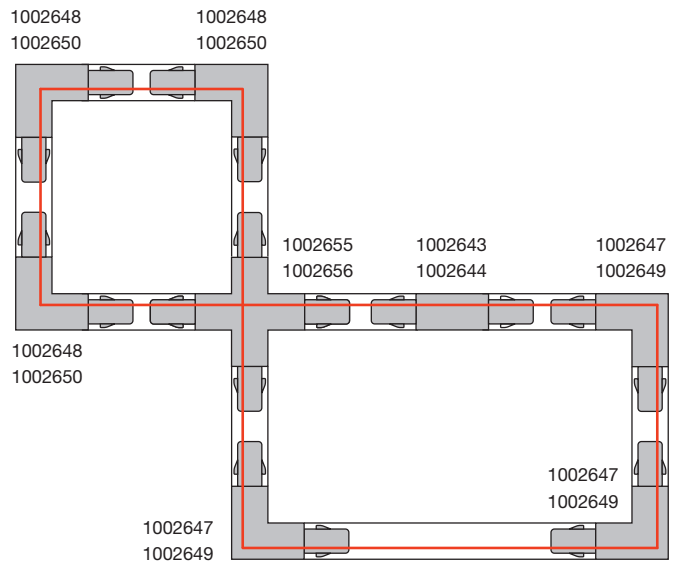
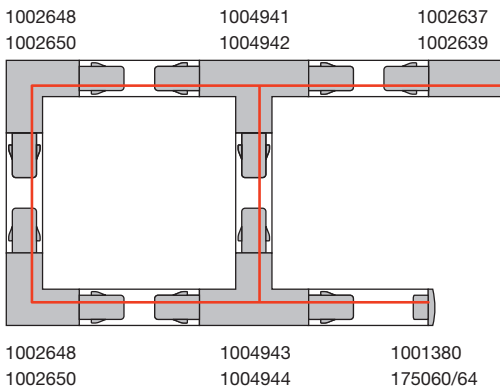
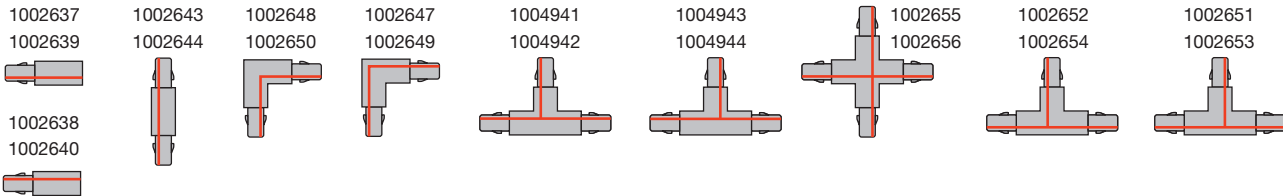
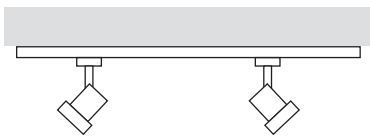





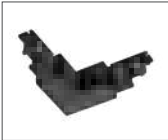





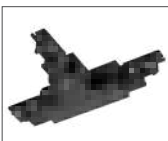

EUR

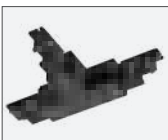
S-TRACK

3-Phasen-Aufbauschiene DALI Planungshilfe und Zubehör auf einen Blick

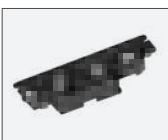
Ansicht der Bauteile von oben
auf die Montageseite

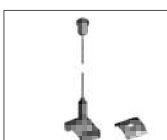

	Einspeiser, DALI, Erde links 10A max. Polycarbonat (PC) L: 13,9 cm B: 3,5 cm H: 3,3 cm <input checked="" type="checkbox"/> schwarz Art. Nr. 1002637 <input type="checkbox"/> weiß Art. Nr. 1002639		Isolierverbinder Polycarbonat (PC) L: 6,8 cm B: 3,1 cm H: 2,6 cm <input checked="" type="checkbox"/> schwarz Art. Nr. 175080 <input type="checkbox"/> weiß Art. Nr. 1001382
	Einspeiser, DALI, Erde rechts 16A max. Polycarbonat (PC) L: 13,9 cm B: 3,5 cm H: 3,3 cm <input checked="" type="checkbox"/> schwarz Art. Nr. 1002638 <input type="checkbox"/> weiß Art. Nr. 1002640		Befestigungsklemme Stahl L: 4 cm B: 3,4 cm H: 1,25 cm <input checked="" type="checkbox"/> schwarz Art. Nr. 1002657 <input type="checkbox"/> weiß Art. Nr. 1002658
	Einspeiser, DALI, Erde außen 16A max. Polycarbonat (PC) L: 11,9 cm B: 11,9 cm H: 3,3 cm <input checked="" type="checkbox"/> schwarz Art. Nr. 1002647 <input type="checkbox"/> weiß Art. Nr. 1002649		3-Phasen Adapter, DALI 10A max. Polycarbonat (PC) L: 11,3 cm B: 5,5 cm H: 3,3 cm <input checked="" type="checkbox"/> schwarz Art. Nr. 1002660 <input type="checkbox"/> weiß Art. Nr. 1002659
	Einspeiser, DALI, Erde innen 16A max. Polycarbonat (PC) L: 11,9 cm B: 11,9 cm H: 3,3 cm <input checked="" type="checkbox"/> schwarz Art. Nr. 1002648 <input type="checkbox"/> weiß Art. Nr. 1002650		Mech. 3-Phasen Adapter Aluminium / Polycarbonat (PC) L: 6,6 cm B: 6,6 cm H: 3,1 cm <input checked="" type="checkbox"/> schwarz Art. Nr. 175210 <input type="checkbox"/> weiß Art. Nr. 1001395
	T-Verbinder, DALI, Erde außen links* 16A max. Polycarbonat (PC) L: 20,3 cm B: 11,9 cm H: 3,3 cm <input checked="" type="checkbox"/> schwarz Art. Nr. 1002652 <input type="checkbox"/> weiß Art. Nr. 1002654		Abdeckung Polycarbonat (PC) L: 200 cm B: 2,2 cm H: 0,75 cm <input checked="" type="checkbox"/> schwarz Art. Nr. 1004939 <input type="checkbox"/> weiß Art. Nr. 1004940
	T-Verbinder, DALI, Erde außen rechts* 16A max. Polycarbonat (PC) L: 20,3 cm B: 11,9 cm H: 3,3 cm <input checked="" type="checkbox"/> schwarz Art. Nr. 1002651 <input type="checkbox"/> weiß Art. Nr. 1002653		Endkappe Polycarbonat (PC) L: 3,5 cm B: 3,3 cm H: 3,2 cm <input checked="" type="checkbox"/> schwarz Art. Nr. 175060 <input type="checkbox"/> weiß Art. Nr. 1001380
	T-Verbinder, DALI, Erde innen links* 16A max. Polycarbonat (PC) L: 20,3 cm B: 11,9 cm H: 3,3 cm <input checked="" type="checkbox"/> schwarz Art. Nr. 1004941 <input type="checkbox"/> weiß Art. Nr. 1004942		Pendelabhangung Aluminium / Polycarbonat (PC) L: 6 cm B: 6 cm H: 4 cm max. 10 kg <input checked="" type="checkbox"/> schwarz Art. Nr. 175160 <input type="checkbox"/> weiß Art. Nr. 1001390
	T-Verbinder, DALI, Erde innen rechts* 16A max. Polycarbonat (PC) L: 20,3 cm B: 11,9 cm H: 3,3 cm <input checked="" type="checkbox"/> schwarz Art. Nr. 1004943 <input type="checkbox"/> weiß Art. Nr. 1004944		Stostellenverbinder Aluminium L: 18,2 cm B: 3,3 cm H: 2,1 cm <input checked="" type="checkbox"/> schwarz Art. Nr. 175180 <input type="checkbox"/> weiß Art. Nr. 1001392
	X-Verbinder, DALI* 16A max. Polycarbonat (PC) L: 20,3 cm B: 20,3 cm H: 3,3 cm <input checked="" type="checkbox"/> schwarz Art. Nr. 1002655 <input type="checkbox"/> weiß Art. Nr. 1002656		Haken Polycarbonat (PC) / Stahl H: 5,2 cm \varnothing : 2,6 cm max. 10 kg <input checked="" type="checkbox"/> schwarz Art. Nr. 175190 <input type="checkbox"/> weiß Art. Nr. 1001393
	Langsverbinder, DALI 16A max. Polycarbonat (PC) L: 10,6 cm B: 2,5 cm H: 2,8 cm <input checked="" type="checkbox"/> schwarz Art. Nr. 1002641 <input type="checkbox"/> weiß Art. Nr. 1002642		Deckenrosette 16A max. Polycarbonat (PC) H: 3,56 cm \varnothing : 14,32 cm <input checked="" type="checkbox"/> schwarz Art. Nr. 1004684 <input type="checkbox"/> weiß Art. Nr. 1004685
	Langsverbinder, DALI* 10A max. Polycarbonat (PC) L: 20,3 cm B: 3,5 cm H: 3,3 cm <input checked="" type="checkbox"/> schwarz Art. Nr. 1002643 <input type="checkbox"/> weiß Art. Nr. 1002644		Drahtseilabhangung 2 Stuck Edelstahl / Messing L: 500 cm max. 10 kg <input checked="" type="checkbox"/> nickel Art. Nr. 1002845
	Flexibler Verbinder, DALI 16A max. Polycarbonat (PC) L: 28,5 cm B: 3,5 cm H: 3,3 cm <input checked="" type="checkbox"/> schwarz Art. Nr. 1002645 <input type="checkbox"/> weiß Art. Nr. 1002646	* mit Einspeisemoglichkeit	



EUTRAC®

3-Phasen-Aufbauschiene



	1 m	1 m	1 m	2 m	2 m	2 m
Nennspannung (V)	220-240V ~50/60Hz	220-240V ~50/60Hz	220-240V ~50/60Hz	220-240V ~50/60Hz	220-240V ~50/60Hz	220-240V ~50/60Hz
max. Stromstärke (A)	16	16	16	16	16	16
Material	Aluminium / Polycarbonat (PC)	Aluminium / Polycarbonat (PC)	Aluminium / Polycarbonat (PC)	Aluminium / Polycarbonat (PC)	Aluminium / Polycarbonat (PC)	Aluminium / Polycarbonat (PC)
Farbe	■ schwarz	□ weiß	■ grau	■ schwarz	□ weiß	■ grau
L x B x H (cm)	100 x 3,6 x 3,2	100 x 3,6 x 3,2	100 x 3,6 x 3,2	200 x 3,6 x 3,2	200 x 3,6 x 3,2	200 x 3,6 x 3,2
Art. Nr.	145100	1001510	145102	145200	1001511	145202
EUR						

Hersteller: EUTRAC® Stromschienen GmbH

	3 m	3 m	3 m
Nennspannung (V)	220-240V ~50/60Hz	220-240V ~50/60Hz	220-240V ~50/60Hz
max. Stromstärke (A)	16	16	16
Material	Aluminium / Polycarbonat (PC)	Aluminium / Polycarbonat (PC)	Aluminium / Polycarbonat (PC)
Farbe	■ schwarz	□ weiß	■ grau
L x B x H (cm)	300 x 3,6 x 3,2	300 x 3,6 x 3,2	300 x 3,6 x 3,2
Art. Nr.	145300	1001512	145302
EUR			

Hersteller: EUTRAC® Stromschienen GmbH

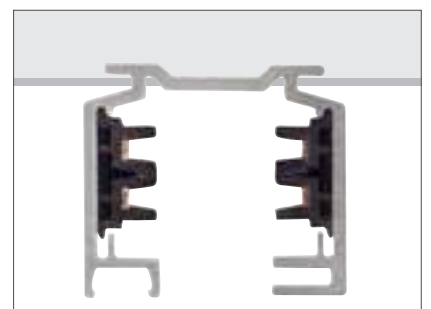

EUTRAC®

Hersteller: EUTRAC® Stromschienen GmbH

3-Phasen-Aufbauschiene Planungshilfe und Zubehör auf einen Blick

Ansicht der Bauteile von oben
auf die Montageseite

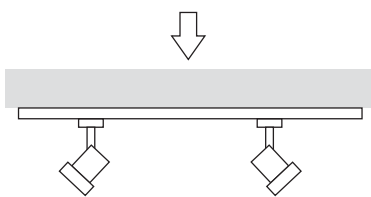

145510
1001513
145514

145520
1001514
145524

145670
1001520
145674

145680
1001521
145684

145630
1001518
145634

145640
1001519
145644

145690
1001522
145694

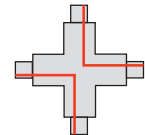

Beispiel: Erde außen

145670
1001520
145674

145670
1001520
145674

145680
1001521
145684

145520
1001514
145524

Beispiel: Erde innen

145510
1001513
145514

145670
1001520
145674

145680
1001521
145684

145690
1001522
145694

145680
1001521
145684

145510
1001513
145514

145630
1001518
145634

145640
1001519
145644

145520
1001514
145524

145680
1001521
145684

**Einspeiser, Erde links**

16A max. | Polycarbonat (PC)
L: 11,2 cm B: 3,6 cm H: 3,2 cm

■ schwarz Art. Nr. **145510**
□ weiß **1001513**
■ grau **145514**

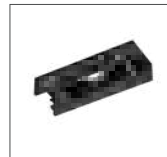
**Stoßstellenverbinder**

Polycarbonat (PC)
L: 10 cm B: 3,6 cm H: 1,9 cm

■ schwarz Art. Nr. **145600**
□ weiß **1001523**
■ grau **145604**

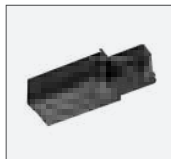
**Einspeiser, Erde rechts**

16A max. | Polycarbonat (PC)
L: 11,2 cm B: 3,6 cm H: 3,2 cm

■ schwarz Art. Nr. **145520**
□ weiß **1001514**
■ grau **145524**

**Flexverbinder**

16A max. | Polycarbonat (PC) / Stahl
L: 22 cm B: 3,6 cm H: 3,2 cm

■ schwarz Art. Nr. **145580**
□ weiß **1001524**
■ grau **145584**

**Mittelspeiser**

16A max. | Polycarbonat (PC)
L: 13 cm B: 3,6 cm H: 3,6 cm

■ schwarz Art. Nr. **145530**
□ weiß **1001515**
■ grau **145534**

**Steckdose**

6,3A max. | Polycarbonat (PC)
L: 9,6 cm B: 6,5 cm H: 9 cm

■ schwarz Art. Nr. **145700**
□ weiß **1001525**

**Längsverbinder***

16A max. | Polycarbonat (PC) / Stahl
L: 26 cm B: 3,6 cm H: 3,2 cm

■ schwarz Art. Nr. **145660**
□ weiß **1001517**
■ grau **145664**

**3-Phasen Leuchtenadapter**

10A max. | Polycarbonat (PC)

■ schwarz Art. Nr. **145990**
□ weiß **1001542**
■ grau **145994**

**Längsverbinder**

16A max. | Polycarbonat (PC)
L: 5,8 cm B: 1,5 cm H: 2,6 cm

■ schwarz Art. Nr. **145660**
□ weiß **1001516**
■ grau **145664**

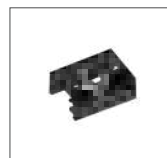
**Pendelclip**

Aluminium
L: 5 cm B: 3,6 cm H: 1,9 cm

■ schwarz Art. Nr. **145730**
□ weiß **1001530**
■ grau **145734**

**L-Verbinder, Erde innen***

16A max. | Polycarbonat (PC) / Stahl
L: 15 cm B: 15 cm H: 3,2 cm

■ schwarz Art. Nr. **145680**
□ weiß **1001521**
■ grau **145684**

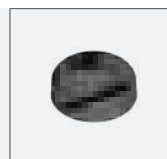
**Punktauslass**

16A max. | Polycarbonat (PC)
H: 3,1 cm Ø: 11,9 cm

■ schwarz Art. Nr. **145830**
□ weiß **1001526**
■ grau **145834**

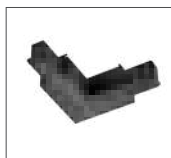
**L-Verbinder, Erde außen***

16A max. | Polycarbonat (PC) / Stahl
L: 15 cm B: 15 cm H: 3,2 cm

■ schwarz Art. Nr. **145670**
□ weiß **1001520**
■ grau **145674**

**Endkappe**

Polycarbonat (PC)
L: 3,6 cm B: 1,7 cm H: 3,2 cm

■ schwarz Art. Nr. **145590**
□ weiß **1001527**
■ grau **145594**

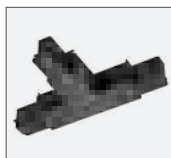
**T-Verbinder, Erde innen links***

16A max. | Polycarbonat (PC) / Stahl
L: 26 cm B: 18,5 cm H: 3,2 cm

■ schwarz Art. Nr. **145630**
□ weiß **1001518**
■ grau **145634**

**Pendelabhangung**

Polycarbonat (PC) / Stahl
L: 60 cm H: 63,5 cm Ø: 7 cm

■ schwarz Art. Nr. **145720**
□ weiß **1001529**
■ grau **145724**

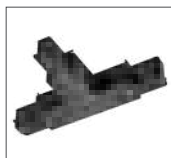
**T-Verbinder, Erde innen rechts***

16A max. | Polycarbonat (PC) / Stahl
L: 26 cm B: 18,5 cm H: 3,2 cm

■ schwarz Art. Nr. **145640**
□ weiß **1001519**
■ grau **145644**

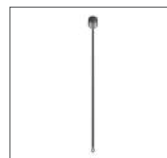
**Pendelabhangung**

Polycarbonat (PC) / Stahl
L: 120 cm H: 122 cm Ø: 7 cm

■ schwarz Art. Nr. **145710**
□ weiß **1001528**
■ grau **145714**

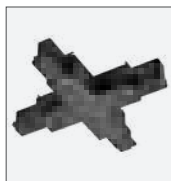
**X-Verbinder***

16A max. | Polycarbonat (PC) / Stahl
L: 26 cm B: 26 cm H: 3,2 cm
2 getrennte Stromkreise

■ schwarz Art. Nr. **145690**
□ weiß **1001522**
■ grau **145694**

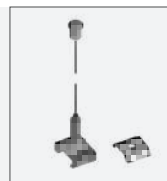
**Drahtseilabhangung 2 Stuck**

Edelstahl / Messing
L: 500 cm | max. 10 kg

■ nickel Art. Nr. **1002845**

* mit Einspeisemoglichkeit



EUTRAC®

3-Phasen-Einbauschiene mit passendem Zubehör

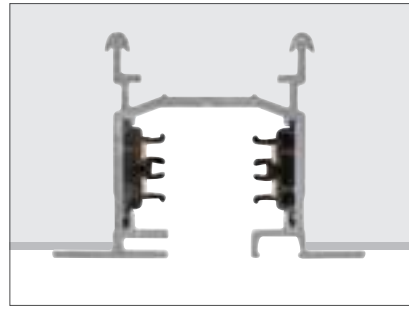

	2 m	3 m
Nennspannung (V)	220-240V ~50/60Hz	220-240V ~50/60Hz
max. Stromstärke (A)	16	16
Material	Aluminium / Polycarbonat (PC)	Aluminium / Polycarbonat (PC)
Farbe	<input type="checkbox"/> weiß	<input type="checkbox"/> weiß
L x B x H (cm)	200 x 5,9 x 4,1	300 x 5,9 x 4,1
Einbau-B (cm)	4	4
Art. Nr.	1001531	1001532
EUR		

Hersteller: EUTRAC® Stromschienen GmbH



Einspeiser, Erde links

16A max. | Polycarbonat (PC) / Stahl
L: 12,2 cm B: 6 cm H: 3,4 cm

weiß

Art. Nr. 1001533



Endkappe

Polycarbonat (PC)
L: 2,7 cm B: 6 cm H: 3,2 cm

weiß

Art. Nr. 1001538



Einspeiser, Erde rechts

16A max. | Polycarbonat (PC) / Stahl
L: 12,2 cm B: 6 cm H: 3,4 cm

weiß

Art. Nr. 1001534



Längsverbinder mit Stabilisator

16A max. | Polycarbonat (PC) / Stahl
L: 6,2 cm B: 2,5 cm H: 2,7 cm

weiß

Art. Nr. 1001539

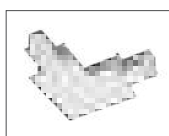

Vertiefte L-Verbinder mit Einspeisung

16A max. | Polycarbonat (PC) / Stahl
L: 16 cm B: 16 cm H: 3,2 cm
Erde außen, mit Einspeisemöglichkeit

weiß

Art. Nr. 1001536

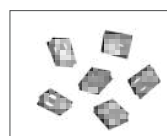

Federclip

Stahl
L: 2 cm B: 1 cm H: 2,5 cm

grau

Art. Nr. 145551



Vertiefte L-Verbinder mit Einspeisung

16A max. | Polycarbonat (PC) / Stahl
L: 16 cm B: 16 cm H: 3,2 cm
Erde innen, mit Einspeisemöglichkeit

weiß

Art. Nr. 1001537



3-Phasen Leuchtenadapter

10A max. | Polycarbonat (PC)

weiß

Art. Nr. 1001542

SIGHT TRACK
3Ph., DALI



NEW

CCT

DALI



1002661 440

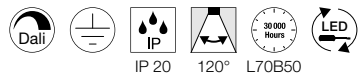
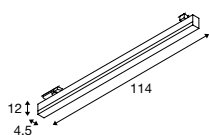
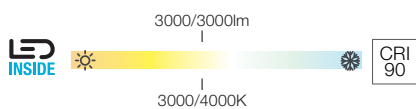
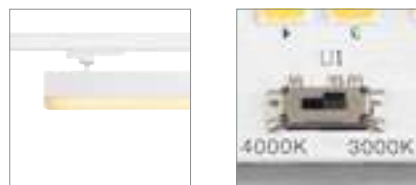

220-240V ~50/60Hz | 700mA
Systemleistung: 39W
Material: Aluminium / Acryl



1005397, 1005399	3000/3000lm 3000/4000K	A → G A F
---------------------	---------------------------	--------------

Variante	Art. Nr.
3000/3000lm 3000/4000K CRI90	
■ schwarz	1005397 ■
3000/3000lm 3000/4000K CRI90	
□ weiß	1005399 ■

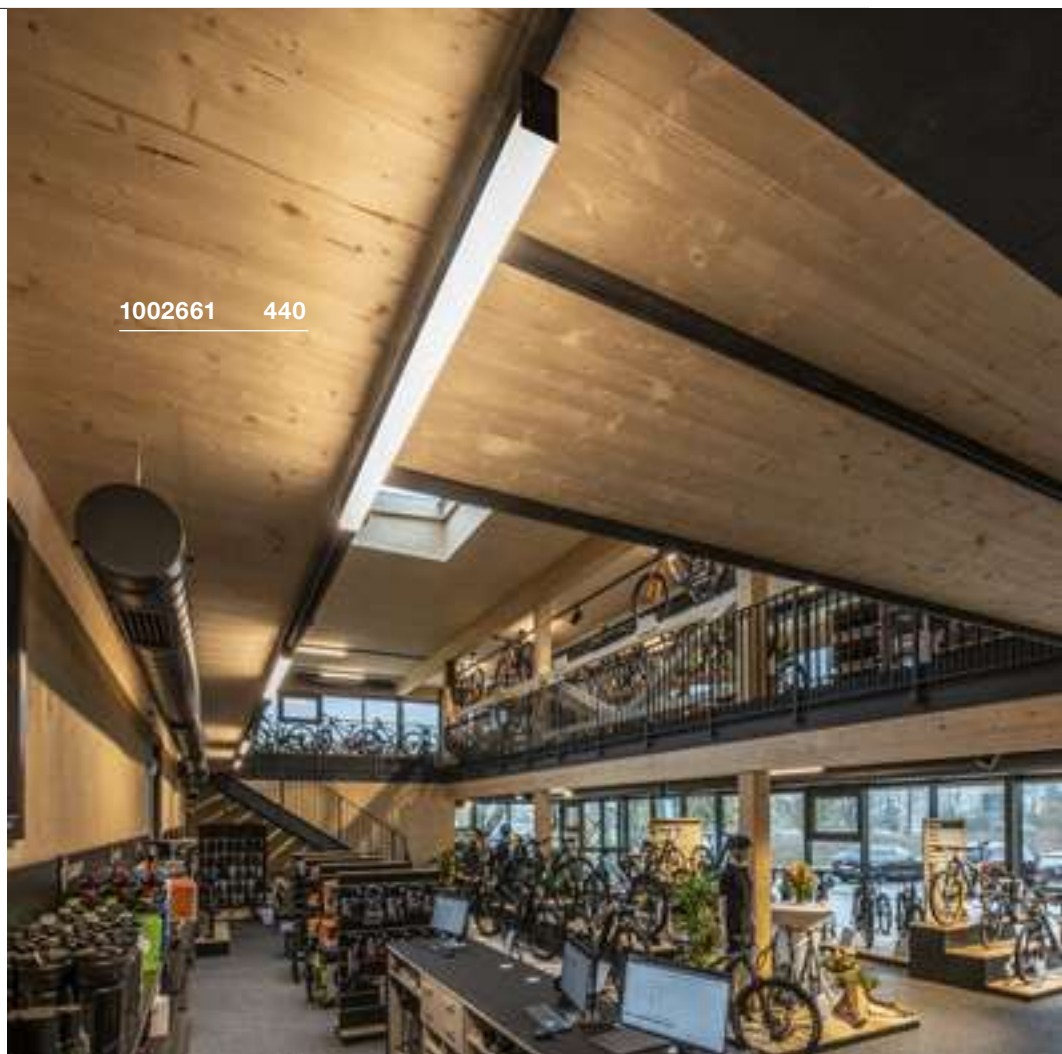

1002662 440



1004691 441



1004690 441

SIGHT MOVE
3Ph., DALI

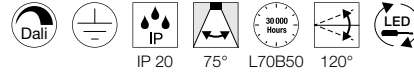
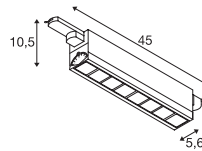
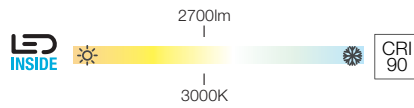

220-240V ~50/60Hz | 350mA
Systemleistung: 26W
Material: Aluminium / Polymethylacrylat (PMMA)

SIGHT MOVE
3Ph., DALI

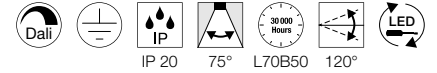
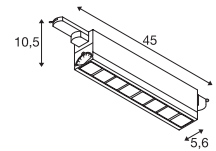
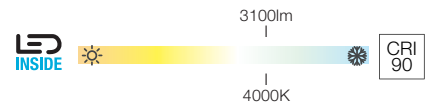

220-240V ~50/60Hz | 350mA
Systemleistung: 26W
Material: Aluminium / Polymethylacrylat (PMMA)



hv		A → G
1004690, 1004691	2700lm 3000K	A f G E

Variante	Art. Nr.
2700lm 3000K CRI90	
■ schwarz	1004690
2700lm 3000K CRI90	
□ weiß	1004691



hv		A → G
1004692, 1004693	3100lm 4000K	A f G E

Variante	Art. Nr.
3100lm 4000K CRI90	
■ schwarz	1004692
3100lm 4000K CRI90	
□ weiß	1004693



1004769 443





1004770 443



1004771 443

ONE 40 TRACK
3Ph., DALI

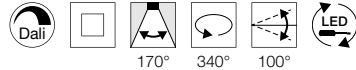
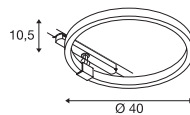
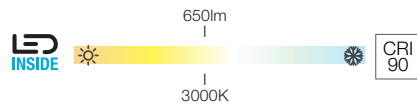

220-240V ~50/60Hz | 350mA
Systemleistung: 15,2W
Material: Aluminium

ONE 40 TRACK
3Ph., DALI

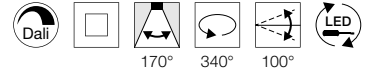
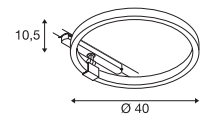
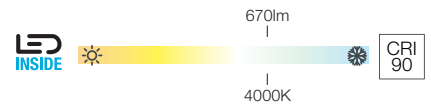

220-240V ~50/60Hz | 350mA
Systemleistung: 15,2W
Material: Aluminium



hv		A → G
1004769, 1004770	650lm 3000K	A f G E

Variante	Art. Nr.
650lm 3000K CRI90	
■ schwarz	1004769
650lm 3000K CRI90	
□ weiß	1004770



hv		A → G
1004771, 1004772	670lm 4000K	A f G E

Variante	Art. Nr.
670lm 4000K CRI90	
■ schwarz	1004771
670lm 4000K CRI90	
□ weiß	1004772

PARA CONE GL
3Ph., GU10



NEW

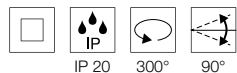
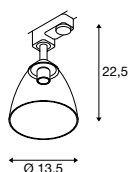

220-240V ~50/60Hz
Material: Aluminium / Glas



GU10 <25W



LED GU10 | 3,2W
2700K | 270lm | EEK=G
4kWh/1000h



Art. Nr. 1003101

Variante	Art. Nr.
1xGU10	
■ schwarz	1006157 ■
1xGU10	
□ weiß	1006158 ■

PARA CONE GL
PD, GU10



NEW

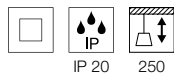
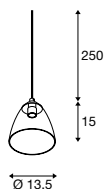

220-240V ~50/60Hz
Material: Aluminium / Glas



GU10 <25W



LED GU10 | 3,2W
2700K | 270lm | EEK=G
4kWh/1000h



Art. Nr. 1003101

Variante	Art. Nr.
1xGU10	
■ schwarz	1006159 ■
1xGU10	
□ weiß	1006160 ■





1006159 444



1002876 445

PARA CONE 14
3Ph., QPAR111

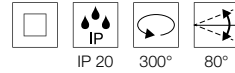
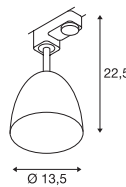

220-240V ~50/60Hz
Material: Stahl



GU10 <25W



LED GU10 | 6W | 36°
2700K | 900lm | EEK=G
6kWh/1000h

Art. Nr. 1005273

Variante	Art. Nr.
1xGU10	
■ schwarz	1002876
1xGU10	
□ weiß	1002877
1xGU10	
■ kupfer	1002878

PARA CONE 14
3Ph., PD, QPAR51

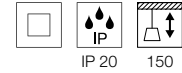
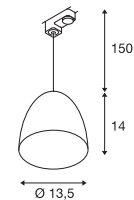

220-240V ~50/60Hz
Material: Stahl

- Textilkabel
- Schwarz/gold Version mit goldenem Reflektor
- Alle anderen Version mit weißen Reflektor



GU10 <25W



LED GU10 | 6W | 38°
3000K | 450lm | EEK=G
6kWh/1000h

Art. Nr. 1005080

Variante	Art. Nr.
1xGU10	
■ schwarz	153140
1xGU10	
□ weiß	153141
1xGU10	
■ kupfer	1002686

LIGHT EYE® 150 TRACK
3Ph. QPAR111

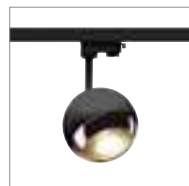

<75 W

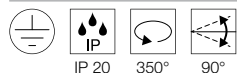
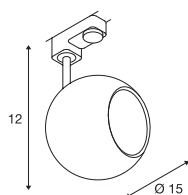

230V ~50Hz
Material: Stahl

LIGHT EYE® 150
3Ph. PD, QPAR111

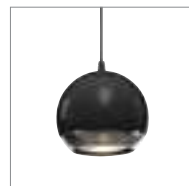

<75 W

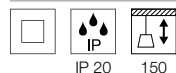
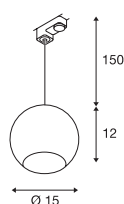

230V ~50Hz
Material: Stahl



1000707 446

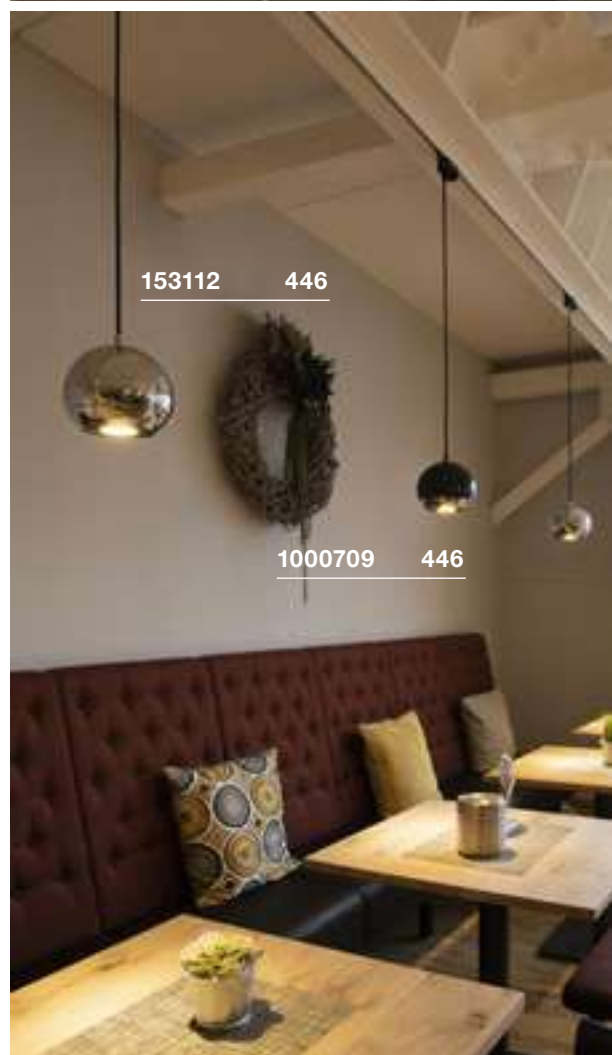

153112 446

1000709 446



GU10 <75W



QPAR111 | 12,5W | 30°
4000K | 1000lm | EEK=F
13kWh/1000h



Art. Nr. 1005282



GU10 <75W



QPAR111 | 12,5W | 30°
2700K | 950lm | EEK=F
13kWh/1000h



Art. Nr. 1005276

Variante	Art. Nr.
1xGU10	
■ schwarz / chrom	1000707
1xGU10	
■ weiß / chrom	1000708

Variante	Art. Nr.
1xGU10	
■ schwarz / chrom	1000709
1xGU10	
■ chrom	153112



153130 447

FORCHINI M 40 TRACK
 3Ph., PD, E27

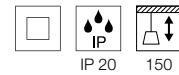
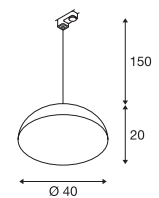
SOCKET INSIDE **<40 W**

 230V ~50Hz
 Material: Aluminium / Stahl

 E27 <40W
 Ø: 6,8 cm L: 15,2 cm

 LED E27 | 7,5W | 320°
 2500K | 700lm | EEK=F
 8kWh/1000h

Art. Nr. 1005265

Variante	Art. Nr.
1xE27	
■ schwarz / gold	153130

SIGHT MOVE
3Ph.



SIGHT MOVE
3Ph.

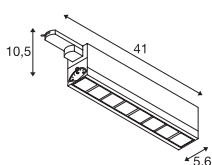
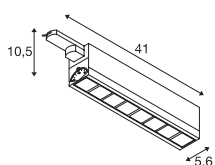
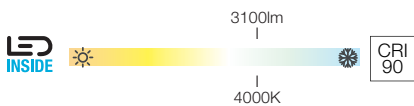
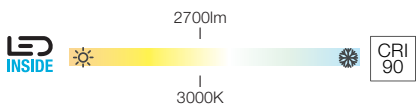

220-240V ~50/60Hz | 350mA
Systemleistung: 26W
Material: Aluminium / Polymethylacrylat (PMMA)

220-240V ~50/60Hz | 350mA
Systemleistung: 26W
Material: Aluminium / Polymethylacrylat (PMMA)

1004686, 1004687	2700lm 3000K	

1004688, 1004689	3100lm 4000K	

Variante	Art. Nr.
2700lm 3000K CRI90	
■ schwarz	1004686
2700lm 3000K CRI90	
□ weiß	1004687

Variante	Art. Nr.
3100lm 4000K CRI90	
■ schwarz	1004688
3100lm 4000K CRI90	
□ weiß	1004689



1004686 448



SIGHT TRACK
3Ph.



NEW

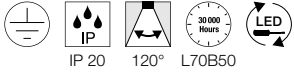
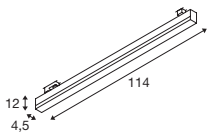
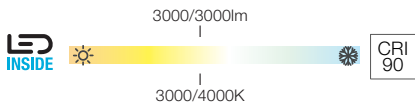

220-240V ~50/60Hz | 700mA
Systemleistung: 37W
Material: Aluminium /Acryl



1005400, 1005401, 1005402	3000/3000lm 3000/4000K	

Variante	Art. Nr.
3000/3000lm 3000/4000K CRI 90 ■ schwarz	1005400 ■
3000/3000lm 3000/4000K CRI 90 □ weiß	1005401 ■
3000/3000lm 3000/4000K CRI 90 ■ grau	1005402 ■



1005400 450



1005401 450



EURO CUBE
3Ph.

EURO CUBE
3Ph.

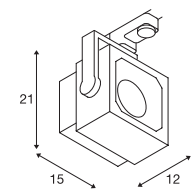
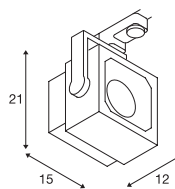
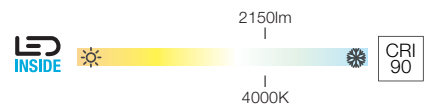
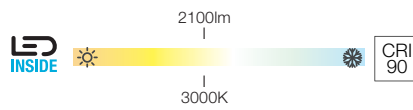

220-240V ~50/60Hz | 700mA
Systemleistung: 28,5W
Material: Aluminium

220-240V ~50/60Hz | 700mA
Systemleistung: 28,5W
Material: Aluminium



152750, 152751	2100lm 3000K	

152780, 152781	2150lm 4000K	

Variante	Art. Nr.
2100lm 3000K CRI90 60°	
■ schwarz	152750
2100lm 3000K CRI90 60°	
□ weiß	152751

Variante	Art. Nr.
2150lm 4000K CRI90 60°	
■ schwarz	152780
2150lm 4000K CRI90 60°	
□ weiß	152781

EURO SPOT TRACK
3Ph., QPAR111

EURO SPOT TRACK
3Ph., QPAR51



<75 W



<25 W

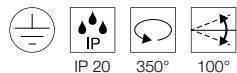
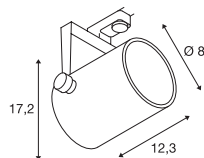
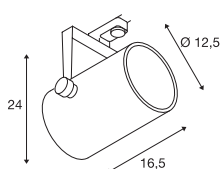

220-240V ~50Hz
Material: Aluminium

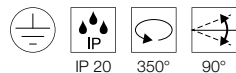

220-240V ~50Hz
Material: Aluminium / Glas



GU10 <75W



QPAR111 | 12,5W | 30°
4000K | 1000lm | EEK=F
13kWh/1000h



Art. Nr. 1005282



GU10 <25W



LED GU10 51mm | 6W | 38°
2700K | 450lm | EEK=G
6kWh/1000h



Art. Nr. 1005076

Variante	Art. Nr.
1xGU10	
■ schwarz	153420
1xGU10	
□ weiß	153421

Variante	Art. Nr.
1xGU10	
■ schwarz	153850
1xGU10	
□ weiß	153851

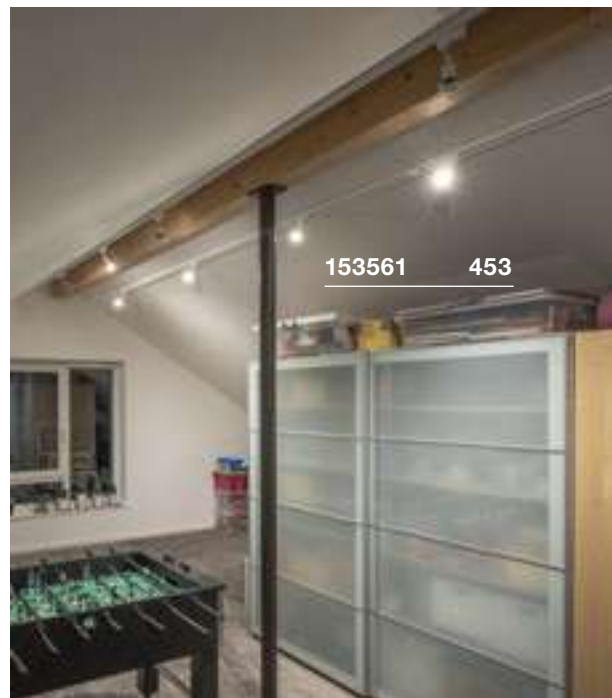
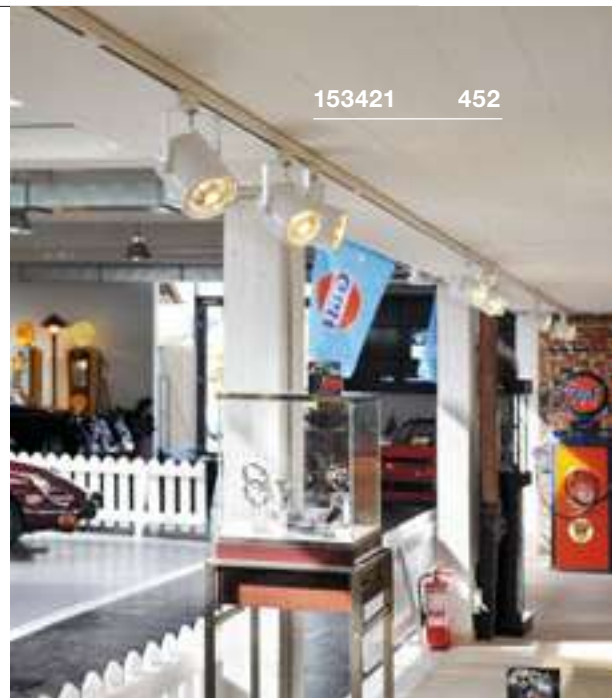

ALTRA DICE TRACK
3Ph., QPAR51

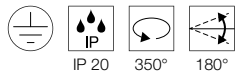
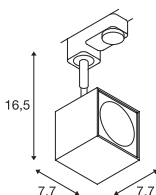

220-240V ~50/60Hz
Material: Aluminium

PURI TRACK
3Ph., QPAR51

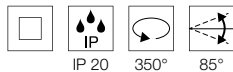
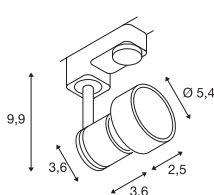

220-240V ~50/60Hz
Material: Aluminium / Polycarbonat (PC)

- Dekoring für QPAR51 inkl.

PURI TRACK
3Ph., QPAR51

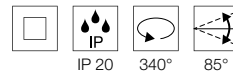
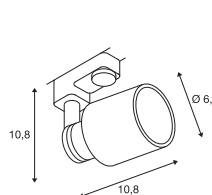

220-240V ~50/60Hz
Material: Aluminium / Kunststoff



GU10 <50W
Ø: 5 cm L: 5,7 cm



LED GU10 51mm | 4W | 36°
3000K | 280lm | EEK=F
4kWh/1000h

Art. Nr. 1004973

Variante	Art. Nr.
1xGU10	
■ schwarz	152320
1xGU10	
□ weiß	152321



GU10 <50W
Ø: 11 cm L: 7,8 cm



LED GU10 51mm | 4W | 36°
2700K | 270lm | EEK=G
4kWh/1000h

Art. Nr. 1004972

Variante	Art. Nr.
1xGU10	
■ schwarz	153560
1xGU10	
□ weiß	153561
1xGU10	
■ grau	153564



GU10 <10W



LED GU10 51mm | 6W | 38°
2700K | 450lm | EEK=G
6kWh/1000h

Art. Nr. 1005076

Variante	Art. Nr.
1xGU10	
■ schwarz	1001871
1xGU10	
□ weiß	1001872

KALU TRACK
3Ph., PHASE



KALU TRACK
3Ph., QPAR111



KALU TRACK
3Ph., QR111

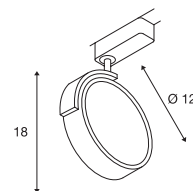
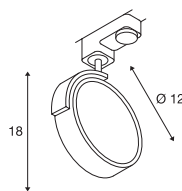
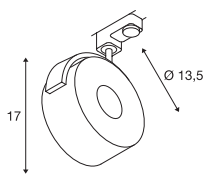
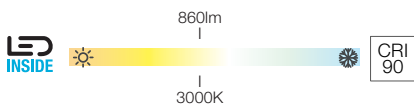
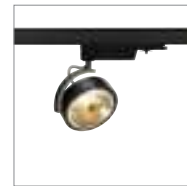
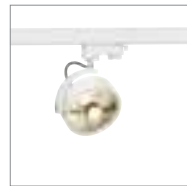

220-240V ~50/60Hz | 12V
Material: Aluminium / Kunststoff

220-240V ~50/60Hz | 12V
Material: Aluminium / Kunststoff

220-240V ~50/60Hz
Systemleistung: 13W
Material: Aluminium

- Produkt nicht zu verwenden mit unseren Deckenrosetten (145830/1001527/145834)

152600, 152601	860lm 3000K	

GU10 <75W
 QPAR111 | 8W | 38°
 2700K | 680lm | EEK=F
 8kWh/1000h
Art. Nr. 1005274

G53 <50W
 LED G53 | 15W | 40°
 2700K | 800lm | EEK=G
 17kWh/1000h
Art. Nr. 560232

Variante	Art. Nr.
860lm 3000K CRI90	
■ schwarz	152600
860lm 3000K CRI80	
□ weiß	152601

Variante	Art. Nr.
1xGU10	
■ schwarz	152610
1xGU10	
□ weiß	152611

Variante	Art. Nr.
1xG53	
■ schwarz	153580
1xG53	
□ weiß	153581



BIMA
3Ph., single, QPAR51

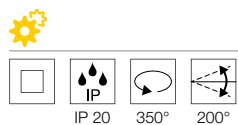
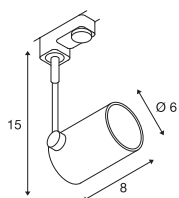

220-240V ~50/60Hz
Material: Aluminium

GU10 <50W
Ø: 5 cm L: 5,7 cm

LED GU10 51mm | 4W | 36°
3000K | 280lm | EEK=F
4kWh/1000h

Art. Nr. 1004973

Variante	Art. Nr.
1xGU10 ■ schwarz	152240
1xGU10 □ weiß	152241
1xGU10 ■ grau	152242

BIMA
3Ph., double, QPAR51

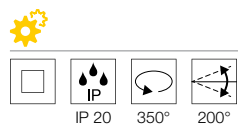
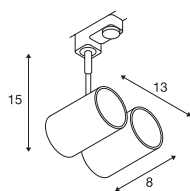

220-240V ~50/60Hz
Material: Aluminium

GU10 <50W
Ø: 5 cm L: 5,7 cm

LED GU10 51mm | 4W | 36°
3000K | 280lm | EEK=F
4kWh/1000h

Art. Nr. 1004973

Variante	Art. Nr.
2xGU10 ■ schwarz	152230
2xGU10 □ weiß	152231
2xGU10 ■ grau	152232

1000657 457





152960 457

STRUCTEC ZOOM 3 Ph.

HELIA 50 TRACK 3Ph.

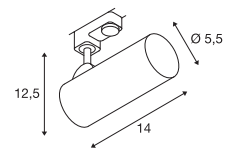
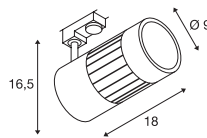
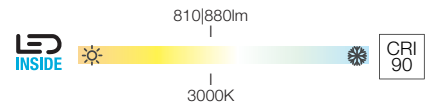
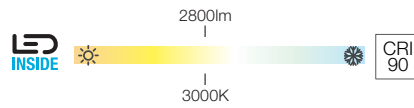

220-240V ~50/60Hz | 900mA
Systemleistung: 34W
Material: Aluminium

- Abstrahlwinkel von 25°-60° über Zoomfunktion wählbar



220-240V ~50/60Hz | 500mA
Systemleistung: 11W
Material: Aluminium



hv		A → G
1000656, 1000657	2800lm 3000K	A F



hv		A → G
152960, 152961	810lm 880lm 3000K	A E

Variante	Art. Nr.
2800lm 3000K CRI90	
■ schwarz	1000656
2800lm 3000K CRI90	
□ weiß	1000657

Variante	Art. Nr.
810lm 3000K CRI90	
■ schwarz	152960
880lm 3000K CRI90	
□ weiß	152961



152430 459



1001420 459

NOBLO SPOT
3Ph.

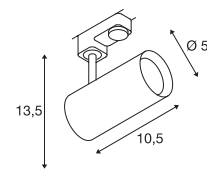
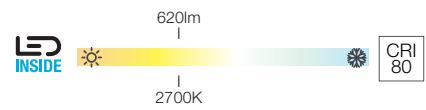
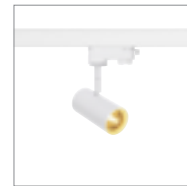

220-240V ~50/60Hz | 350mA
Systemleistung: 7,5W
Material: Aluminium



1001865, 1001866	620lm 2700K	

Variante	Art. Nr.
620lm 2700K CRI80	
■ schwarz	1001865
620lm 2700K CRI80	
□ weiß	1001866

ENOLA C TRACK
3Ph.

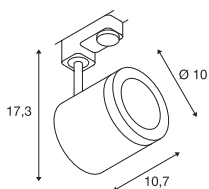
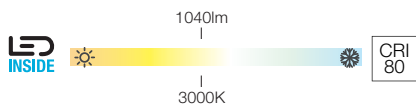

IP 20 | 55° | L70B50 | 350° | 90°

220-240V ~50/60Hz | 500mA
Systemleistung: 11W
Material: Aluminium

152430, 152431	1040lm 3000K	

Variante	Art. Nr.
1040lm 3000K CRI80 55°	
■ schwarz	152430
1040lm 3000K CRI80 55°	
□ weiß	152431

TEC KALU TRACK
3Ph., double, PHASE

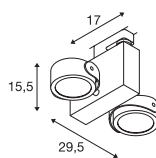
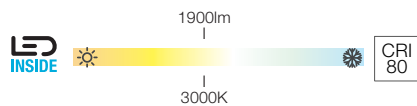

IP 20 | 60° | L70B50 | 350° | 120°

220-240V ~50/60Hz | 700mA
Systemleistung: 31W
Material: Aluminium / Polycarbonat (PC)

1001419, 1001420	1900lm 3000K	

Variante	Art. Nr.
1900lm 3000K CRI80 60°	
■ schwarz	1001419
1900lm 3000K CRI80 60°	
■ weiß / schwarz	1001420

AVO TRACK
3Ph., QPAR51

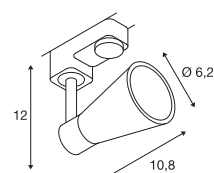
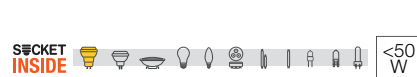

IP 20 | 350° | 90°

230V ~50/60Hz
Material: Stahl

GU10 <50W Ø: 5 cm		

Art. Nr. **1005078**

Variante	Art. Nr.
1xGU10	
■ schwarz	152640
1xGU10	
□ weiß	152641

BLEIBEN IN DER SPUR.

EINFACH GUT BELEUCHTET MIT 1-PHASEN-HOCHVOLT-STROMSCHIENEN.

Die flache Schiene aus Aluminium lässt sich – dank der im Profil vorhandenen Bohrungen – schnell und unkompliziert an Wand oder Decke anbringen. Dabei haben Sie die Wahl zwischen einer Einbauversion und einer Aufbauversion, die in mehreren Farben erhältlich sind.





1006159 472

1004935 471





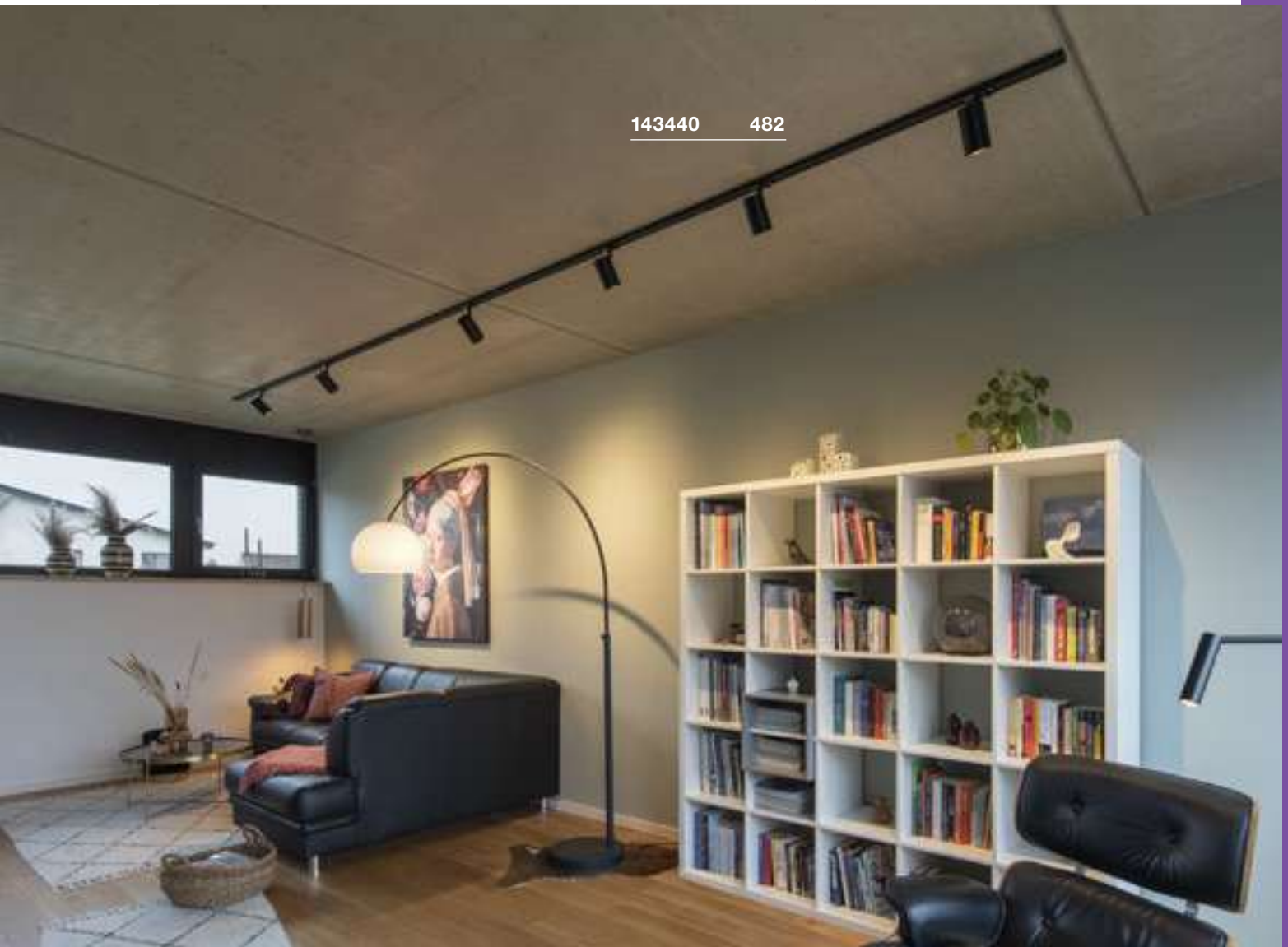



















143450 478

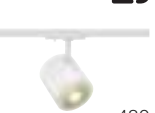

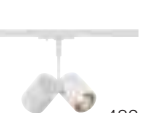

143440 482

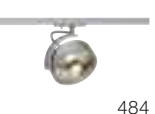
HOCHVOLT-STROMSCHIENE 1-PHASEN

 470	 470	 471	 471	 472	 472	 471	 474
 475	 476	 476	 477	 478	 478	 478	 479
 480	 480	 480	 481	 482	 482	 483	 483
 484	 484	 485	 485				

Passende Einbau- und Aufbauschielen sowie Zubehör finden Sie auf den Seiten 465-469

 Weitere Leuchten und Varianten finden Sie online unter www.slv.com
 Herstellerangaben unserer Leuchtmittlempfehlungen finden Sie Im Kapitel Leuchtmittel ab Seite 808

1000713 476



1-PHASEN

AUFBAUSCHIENE



	1 m	1 m	1 m	2 m	2 m	2 m
Nennspannung (V)	220-240V ~50/60Hz	220-240V ~50/60Hz	220-240V ~50/60Hz	220-240V ~50/60Hz	220-240V ~50/60Hz	220-240V ~50/60Hz
max. Stromstärke (A)	16	16	16	16	16	16
Material	Aluminium	Aluminium	Aluminium	Aluminium	Aluminium	Aluminium
Farbe	■ schwarz	□ weiß	■ grau	■ schwarz	□ weiß	■ grau
L x B x H (cm)	100 x 3,5 x 1,8	100 x 3,5 x 1,8	100 x 3,5 x 1,8	200 x 3,5 x 1,8	200 x 3,5 x 1,8	200 x 3,5 x 1,8
Art. Nr.	143010	143011	143012	143020	143021	143022
EUR						

	3 m	3 m	3 m
Nennspannung (V)	220-240V ~50/60Hz	220-240V ~50/60Hz	220-240V ~50/60Hz
max. Stromstärke (A)	16	16	16
Material	Aluminium	Aluminium	Aluminium
Farbe	■ schwarz	□ weiß	■ grau
L x B x H (cm)	300 x 3,5 x 1,8	300 x 3,5 x 1,8	300 x 3,5 x 1,8
Art. Nr.	1002151	1002152	1002153
EUR			

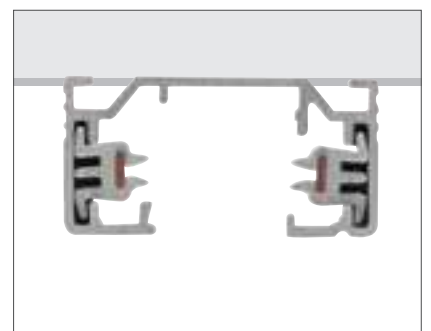

1-PHASEN

Aufbauschiene

Planungshilfe und Zubehör auf einen Blick

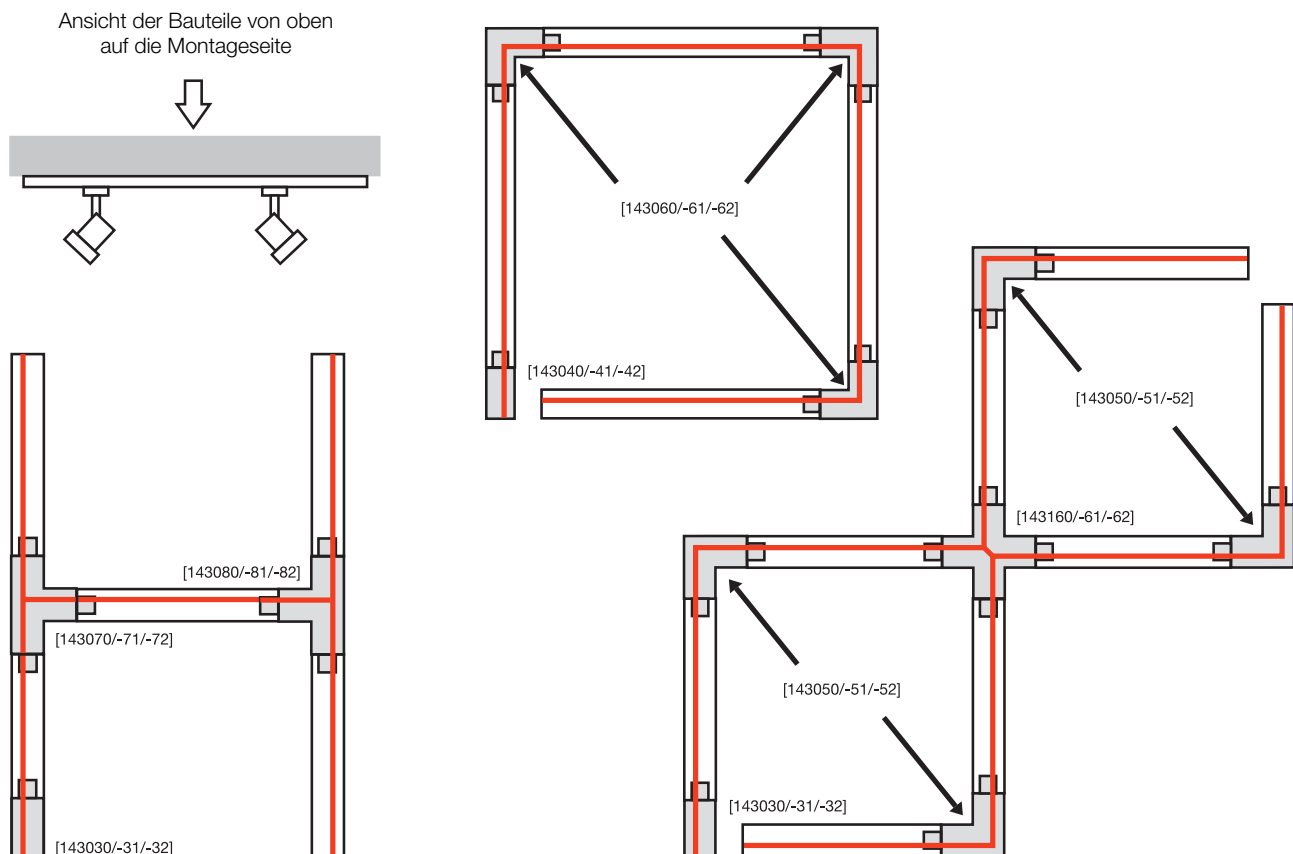

**Einspeiser, Erde links**

16A max. | Polycarbonat (PC)
L: 6,5 cm B: 3,5 cm H: 1,8 cm

■ schwarz Art. Nr. **143030**
□ weiß **143031**
■ grau **143032**

**Stabilisator Längsverbinder**

Stahl
L: 19,7 cm B: 3,2 cm H: 1,3 cm
Zur Verstärkung bei Montage mehrerer Schienen mit Deckenabhangung (1002845)

■ nickel Art. Nr. **143151**

**Einspeiser, Erde rechts**

16A max. | Polycarbonat (PC)
L: 10,4 cm B: 3,5 cm H: 1,8 cm

■ schwarz Art. Nr. **143040**
□ weiß **143041**
■ grau **143042**

**Stabilisator Eckverbinder**

Stahl
L: 11,5 cm B: 11,5 cm H: 0,5 cm
Zur Verstärkung bei Montage mehrerer Schienen mit Deckenabhangung (1002845)

■ nickel Art. Nr. **143152**

**Längsverbinder***

16A max. | Polycarbonat (PC)
L: 17,2 cm B: 3,5 cm H: 1,8 cm

■ schwarz Art. Nr. **143100**
□ weiß **143101**
■ grau **143102**

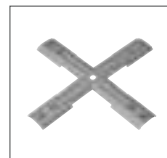
**Stabilisator X-Verbinder**

Stahl
L: 19,7 cm B: 19,7 cm H: 0,5 cm
Zur Verstärkung bei Montage mehrerer Schienen mit Deckenabhangung (1002845).

■ grau Art. Nr. **143169**

**Längsverbinder**

16A max. | Polycarbonat (PC)
L: 6,4 cm B: 3,5 cm H: 1,8 cm

■ schwarz Art. Nr. **143090**
□ weiß **143091**
■ grau **143092**

**1-Phasen Leuchtenadapter**

6A max. | Polycarbonat (PC)
L: 8,2 cm B: 3,5 cm H: 4,2 cm

■ schwarz Art. Nr. **143120**
□ weiß **143121**
■ grau **143124**

**Eckverbinder, Erde innen**

16A max. | Polycarbonat (PC)
L: 10,4 cm B: 10,4 cm H: 1,8 cm

■ schwarz Art. Nr. **143060**
□ weiß **143061**
■ grau **143062**

**1-Phasen Leuchtenadapter mit Haken**

6A max. | Polycarbonat (PC)
L: 8,2 cm B: 3,5 cm H: 7,4 cm

■ schwarz Art. Nr. **143170**
□ weiß **143171**
■ grau **143172**

**Eckverbinder, Erde außen**

16A max. | Polycarbonat (PC)
L: 10,4 cm B: 10,4 cm H: 1,8 cm

■ schwarz Art. Nr. **143050**
□ weiß **143051**
■ grau **143052**

**Abdeckung**

Polycarbonat (PC)
L: 200 cm B: 1,8 cm H: 0,75 cm

■ schwarz Art. Nr. **1004783**
□ weiß **1004785**
■ grau **1004784**

**T-Verbinder, Erde außen links**

16A max. | Polycarbonat (PC)
L: 17,2 cm B: 10,4 cm H: 1,8 cm

■ schwarz Art. Nr. **143070**
□ weiß **143071**
■ grau **143072**

**Endkappe**

Polycarbonat (PC)
L: 0,4 cm B: 3,5 cm H: 1,8 cm

■ schwarz Art. Nr. **143130**
□ weiß **143131**
■ grau **143132**

**T-Verbinder, Erde außen rechts**

16A max. | Polycarbonat (PC)
L: 17,2 cm B: 10,4 cm H: 1,8 cm

■ schwarz Art. Nr. **143080**
□ weiß **143081**
■ grau **143082**

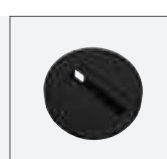
**Deckenrosette**

6A max. | Polycarbonat (PC)
H: 2,5 cm Ø: 12,1 cm

■ schwarz Art. Nr. **143380**
□ weiß **143381**
■ grau **143382**

**X-Verbinder**

16A max. | Polycarbonat (PC)
L: 9,5 cm B: 17,2 cm H: 1,8 cm

■ schwarz Art. Nr. **143160**
□ weiß **143161**
■ grau **143162**

**Drahtseilabhangung 2 Stück**

Edelstahl / Messing
L: 500 cm | max. 10 kg

■ nickel Art. Nr. **1002845**

**Flexverbinder**

16A max. | Polycarbonat (PC)
L: 16,4 cm B: 3,5 cm H: 1,8 cm

■ schwarz Art. Nr. **143110**
□ weiß **143111**
■ grau **143112**

* mit Einspeisemöglichkeit



143580 483

1001406 143

1-PHASEN

Einbauschiene mit passendem Zubehör

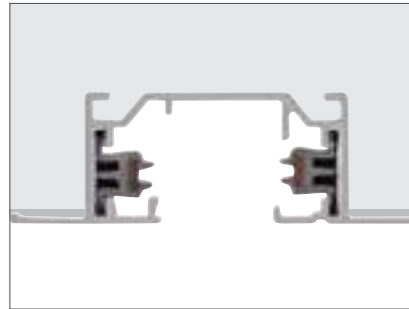

	2 m
Nennspannung (V)	220-240V ~50/60Hz
max. Stromstärke (A)	16
Material	Aluminium
Farbe	<input type="checkbox"/> weiß
L x B x H (cm)	200 x 5,5 x 1,8
Einbau-B (cm)	4
Art. Nr.	143221
EUR	



Einspeiser, Erde links

16A max. | Kunststoff
L: 10,8 cm B: 5,5 cm H: 2 cm
 weiß Art. Nr. **143231**



Endkappe

Kunststoff
L: 2,7 cm B: 5,5 cm H: 1,8 cm
 weiß Art. Nr. **143281**



Einspeiser, Erde rechts

16A max. | Kunststoff
L: 10,8 cm B: 5,5 cm H: 2 cm
 weiß Art. Nr. **143241**



Haltebügel

Stahl
L: 7,5 cm B: 1,5 cm H: 4 cm
 nickel Art. Nr. **143230**



Längsverbinder

16A max. | Kunststoff / Stahl
L: 6,5 cm B: 1,8 cm H: 1,7 cm
 weiß Art. Nr. **143271**



1-Phasen-Adapter mit Haken

6A max. | Polycarbonat (PC)
L: 8,2 cm B: 3,5 cm H: 7,4 cm
 schwarz Art. Nr. **143170**
 weiß **143171**
 grau **143172**



Eckverbinder, Erde innen

16A max. | Kunststoff
L: 11,2 cm B: 11,2 cm H: 2 cm
 weiß Art. Nr. **143261**



1-Phasen Leuchtenadapter

6A max. | Polycarbonat (PC)
L: 8,2 cm B: 3,5 cm H: 4,2 cm
 schwarz Art. Nr. **143120**
 weiß **143121**
 grau **143124**



Eckverbinder, Erde außen

16A max. | Kunststoff
L: 11,2 cm B: 11,2 cm H: 2 cm
 weiß Art. Nr. **143251**

NOBLO SPOT
1Ph., Triple Track Set

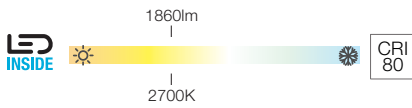
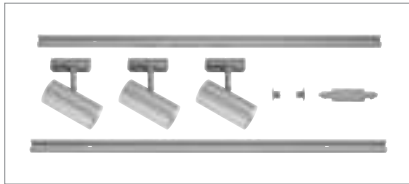

LED INSIDE CRI 80

PURI TRACK
1Ph., Triple Track Set

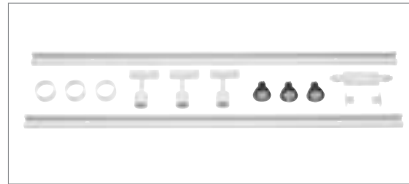

SOCKET INSIDE <50 W

220-240V ~50/60Hz | 350mA
Material: Aluminium

- 2x 1m Hochvoltschiene. 1x Einspeiser/Längsverbinder. 1x 2 Endkappen. 3x Leuchtenkopf NOBLO

230V ~50Hz
Material: Aluminium

- 2x 1m Hochvoltschiene. 1x Längsverbinder. 1x 2 Endkappen. 3x Leuchtenkopf PURI. 3x LED GU10 Leuchtmittel. 3x Dekoring für GU10

		A → G
1002610, 1002611, 1002612	1860lm 2700K	A G E

Variante	Art. Nr.
1860lm 2700K CRI80 ■ schwarz	1002610
1860lm 2700K CRI80 □ weiß	1002611
1860lm 2700K CRI80 ■ grau	1002612

GU10

Variante	Art. Nr.
3xGU10 ■ schwarz	143190
3xGU10 □ weiß	143191
3xGU10 ■ grau	143194



1002611 470



143191 470



1004933 471



1004935 471

PANEL TRACK
1Ph., eckig

NEW

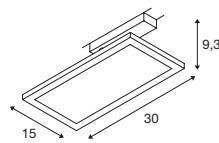

220-240V ~50/60Hz | 450mA
Systemleistung: 18W
Material: Polycarbonat (PC) / Stahl

PANEL TRACK
1Ph., rund

NEW

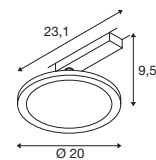
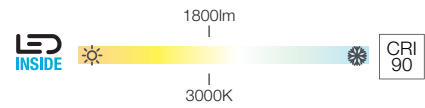
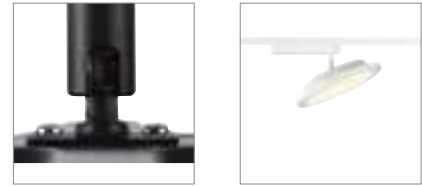

220-240V ~50/60Hz | 450mA
Systemleistung: 18W
Material: Polycarbonat (PC) / Stahl



1004933, 1004934	1800lm 3000K	

Variante	Art. Nr.
1800lm 3000K CRI90	
■ schwarz	1004933 ■
1800lm 3000K CRI90	
□ weiß	1004934 ■



1004935, 1004936	1800lm 3000K	

Variante	Art. Nr.
1800lm 3000K CRI90	
■ schwarz	1004935 ■
1800lm 3000K CRI90	
□ weiß	1004936 ■

PARA CONE GL
1Ph., GU10



NEW

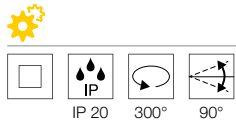
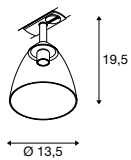

220-240V ~50/60Hz
Material: Aluminium / Glas

GU10 <25W

LED GU10 | 3,2W
2700K | 270lm | EEK=G
4kWh/1000h



Art. Nr. 1003101

Variante	Art. Nr.
1xGU10	
■ schwarz	1006155 ■
1xGU10	
□ weiß	1006156 ■

PARA CONE GL
PD, GU10



NEW

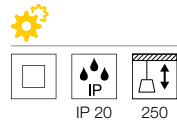
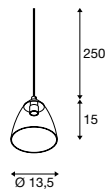

220-240V ~50/60Hz
Material: Aluminium / Glas

GU10 <25W

LED GU10 | 3,2W
2700K | 270lm | EEK=G
4kWh/1000h



Art. Nr. 1003101

Variante	Art. Nr.
1xGU10	
■ schwarz	1006159 ■
1xGU10	
□ weiß	1006160 ■

1006155 472





1006160 472

ZUBEHÖR

Fitu 1er Deckenrosette

16A max.
Stahl
H: 3,9 cm
Ø: 8,5 cm
inkl. Zugentlastung



Variante	Art. Nr.
■ schwarz	132600
□ weiß	132601
■ chrom	132605

Fitu 3er Deckenrosette

16A max.
Stahl
H: 5,4 cm
Ø: 22 cm
inkl. Zugentlastung



Variante	Art. Nr.
■ schwarz	132610
□ weiß	132611
■ chrom	132615 ▼

Deckenrosette 3-fach

16A max.
Stahl
L: 60 cm B: 8,5 cm H: 5 cm
inkl. Zugentlastung



Variante	Art. Nr.
■ schwarz	1001818
□ weiß	1001819

1-Phasen Leuchtenadapter

6A max.
Polycarbonat (PC)
L: 8,2 cm B: 3,5 cm H: 4,2 cm
Max. mechanische Belastung 2 kg



Variante	Art. Nr.
■ schwarz	143120
□ weiß	143121
■ grau	143124

3-Phasen Leuchtenadapter

10A max.
Kunststoff
Max. mechanische Belastung 5 kg



Variante	Art. Nr.
■ schwarz	145990
□ weiß	1001542
■ grau	145994

PARA CONE 14
1Ph., QPAR51

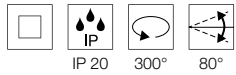
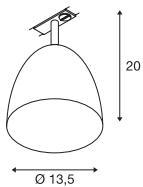

220-240V ~50/60Hz
Material: Stahl



GU10 <25W



LED GU10 | 3,2W
2700K | 270lm | EEK=G
4kWh/1000h



Art. Nr. 1003101

Variante	Art. Nr.
1xGU10	
■ glänzend schwarz	1002873
1xGU10	
□ glänzend weiß	1002874
1xGU10	
■ kupfer	1002875

PARA CONE 14
1Ph., PD, QPAR51

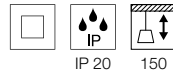
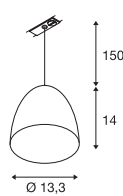

230V ~50Hz
Material: Stahl

- Textilkabel
- schwarz/gold Version mit goldenem Reflektor
- Alle anderen Version mit weißem Reflektor



GU10 <35W



LED GU10 | 3,2W
2700K | 270lm | EEK=G
4kWh/1000h



Art. Nr. 1003101

Variante	Art. Nr.
1xGU10	
■ glänzend schwarz	143990
1xGU10	
□ glänzend weiß	143991
1xGU10	
■ kupfer	1001968



1002873 474

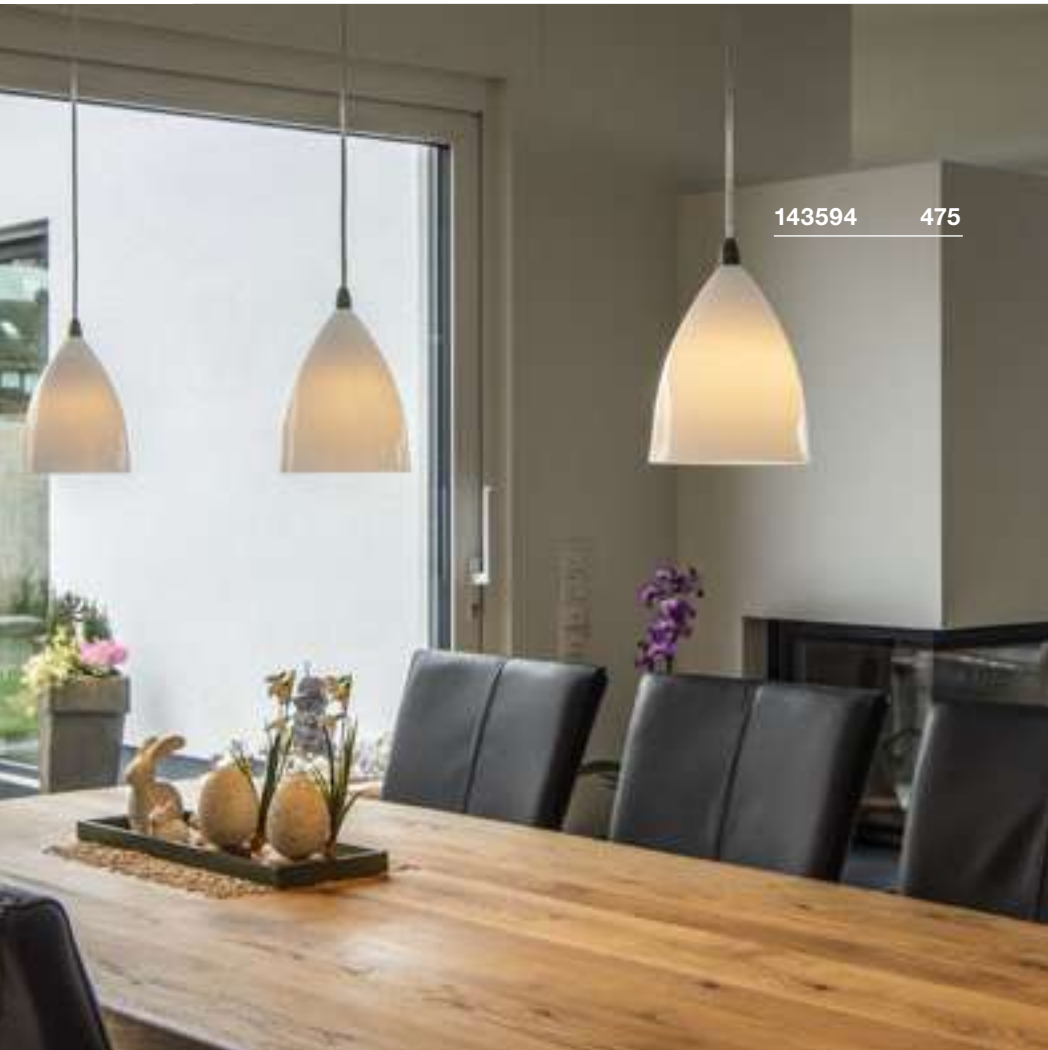

143594 475

TONGA®
1Ph., PD, E14



SOCKET INSIDE <60 W

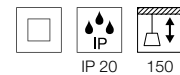
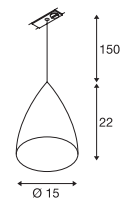

220-240V ~50/60Hz
Material: Aluminium / Glas



1001968 474



E14 <60W
Ø: 5 cm L: 13 cm



LED E14 | 4,2W | 320°
2700K | 370lm | EEK=F
4kWh/1000h



Art. Nr. 1005284

Variante	Art. Nr.
1xE14	
■ grau / milchig	143594

LIGHT EYE® 90
1Ph., QPAR51

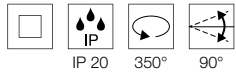
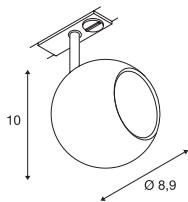

230V ~50/60Hz
Material: Stahl

LIGHT EYE® 150
1Ph., PD, QPAR111

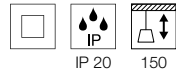
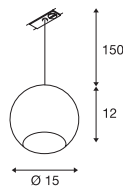

220-240V ~50/60Hz
Material: Stahl

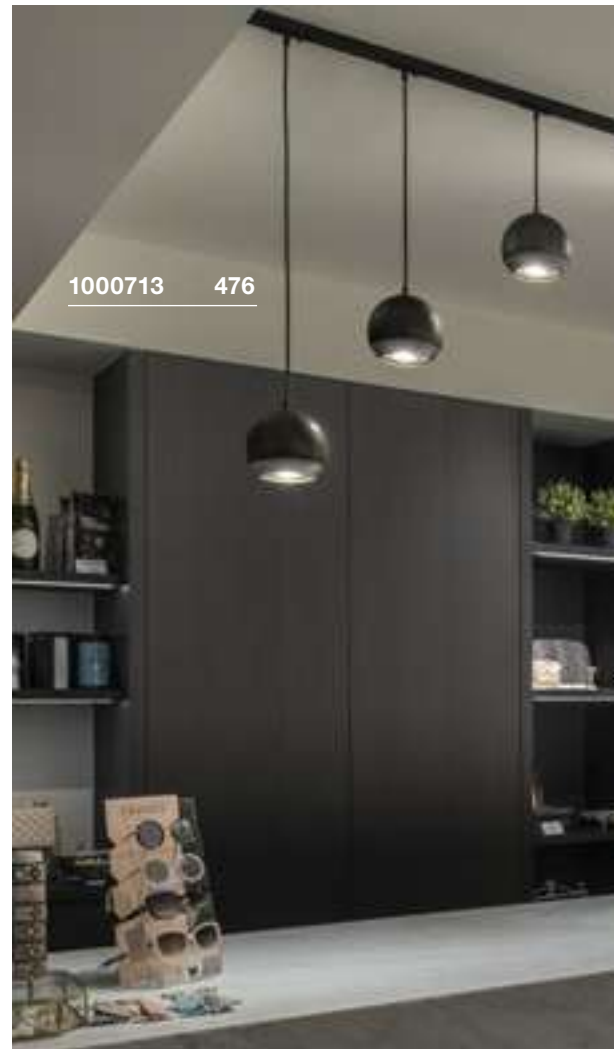
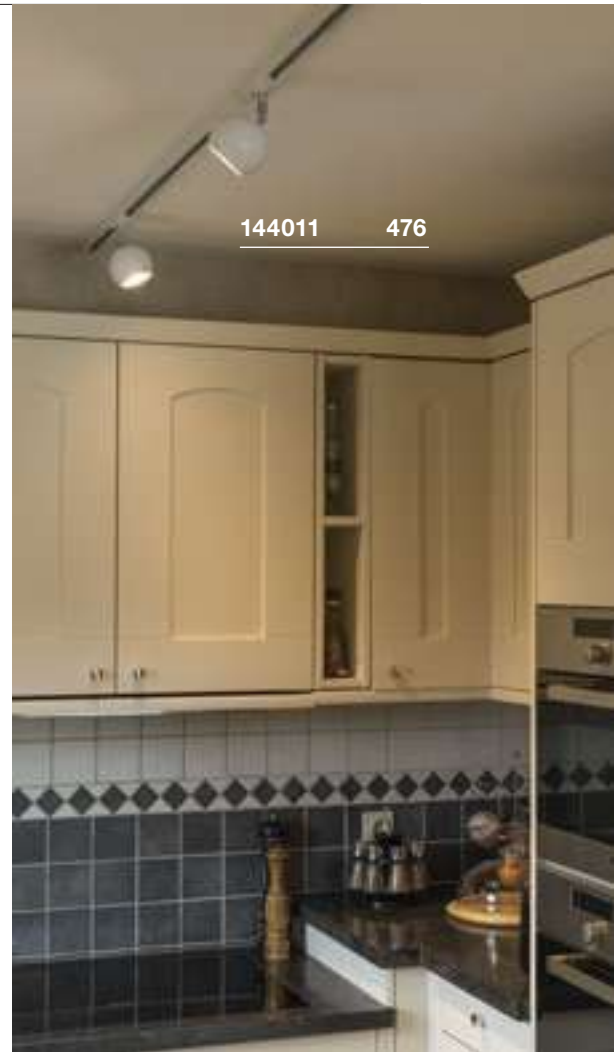

GU10 <50W



LED GU10 51mm | 4W | 36°
2700K | 270lm | EEK=G
4kWh/1000h



Art. Nr. 1004972



- Leuchtmittel Dekoring Ø 5,7 cm
Art. Nr. 151040
- Leuchtmittel Dekoring Ø 5,7 cm
Art. Nr. 151041
- Leuchtmittel Dekoring Ø 5,7 cm
Art. Nr. 151049



GU10 <75W



QPAR111 | 12.5W | 30°
2700K | 950lm | EEK=F
13kWh/1000h



Art. Nr. 1005276

Variante	Art. Nr.
1xGU10	
■ schwarz/chrom	144010
1xGU10	
■ weiß/chrom	144011
1xGU10	
■ kupfer	144019

Variante	Art. Nr.
1xGU10	
■ schwarz/chrom	1000713
1xGU10	
■ weiß/chrom	143621
1xGU10	
■ chrom	143620

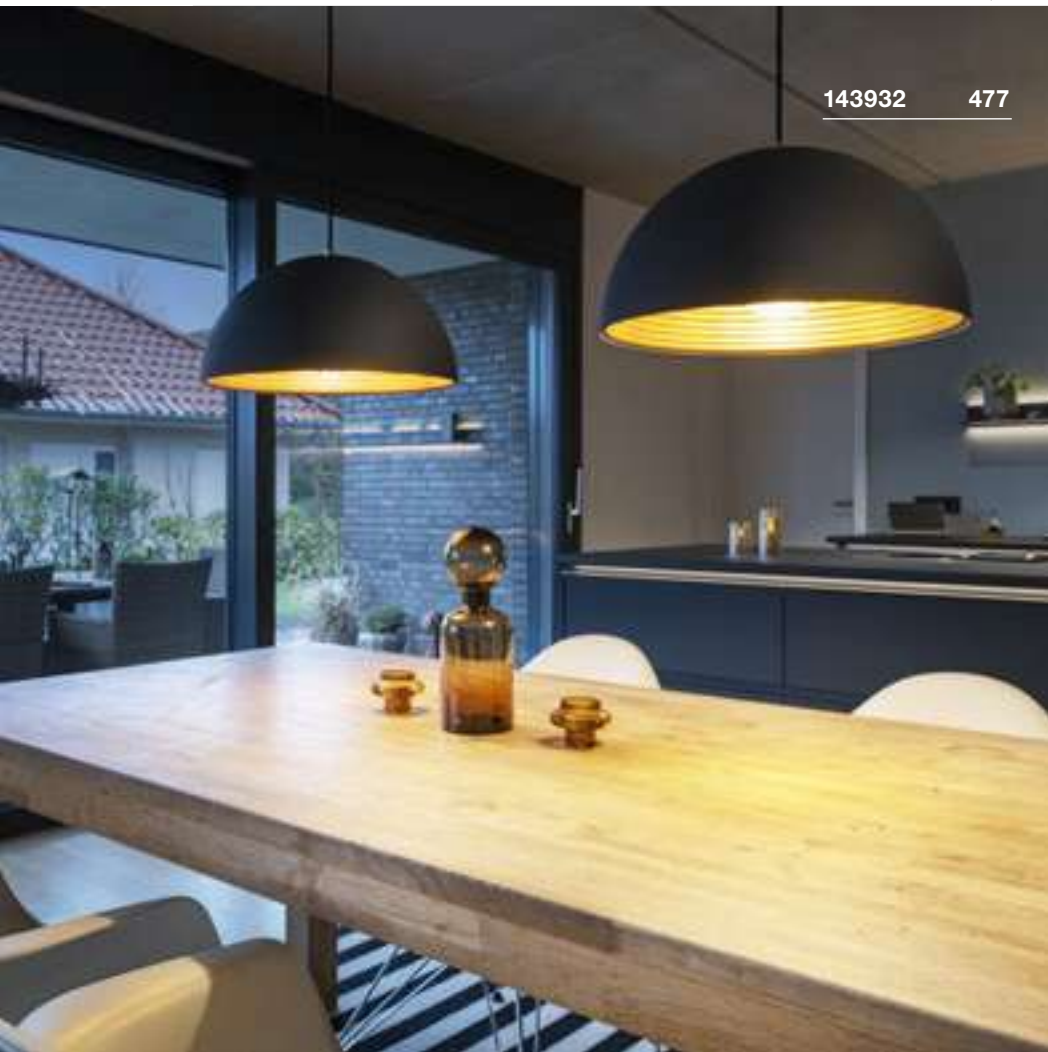

143932

477

FORCHINI M 40 TRACK
 1Ph., E27

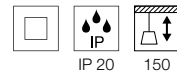
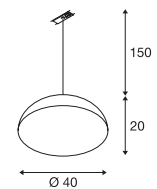
SOCKET INSIDE <40 W

 220-240V ~50/60Hz
 Material: Aluminium / Stahl

- Pendelleuchten-Adapter Farbe silbergrau [143930] / schwarz [143932]



 E27 <40W
 Ø: 6,8 cm L: 15,2 cm

 LED E27 | 7,5W | 320°
 2700K | 800lm | EEK=F
 8kWh/1000h

Art. Nr. 1005303

Variante	Art. Nr.
1xE27	
schwarz/gold	143930
1xE27	
schwarz/gold	143932

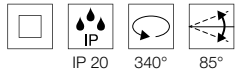
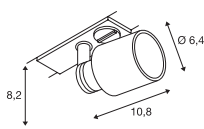
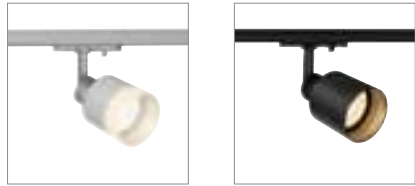
PURI TRACK
1Ph., QPAR51



220-240V ~50/60Hz
Material: Aluminium / Kunststoff

PURI TRACK
1Ph., QPAR51

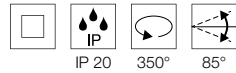
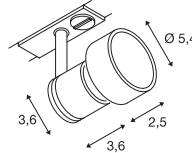

220-240V ~50/60Hz
Material: Aluminium / Polycarbonat (PC)

- Dekoring für QPAR51 inkl.

PURIA TRACK
1Ph., QPAR51

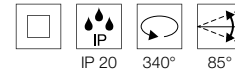
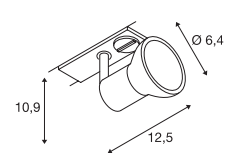

220-240V ~50/60Hz
Material: Aluminium / Kunststoff



GU10 <10W



LED GU10 51mm | 6W | 38°
2700K | 450lm | EEK=G
6kWh/1000h



Art. Nr. 1005077



GU10 <50W



LED GU10 51mm | 4W | 36°
2700K | 270lm | EEK=G
4kWh/1000h



Art. Nr. 1004972



GU10 <10W



LED GU10 51mm | 4W | 36°
3000K | 270lm | EEK=G
4kWh/1000h



Art. Nr. 1004973

Variante	Art. Nr.
1xGU10	
■ schwarz	1001868
1xGU10	
□ weiß	1001869
1xGU10	
■ grau	1001870

Variante	Art. Nr.
1xGU10	
■ schwarz	143390
1xGU10	
□ weiß	143391
1xGU10	
■ grau	143392

Variante	Art. Nr.
1xGU10	
■ schwarz	143450
1xGU10	
□ weiß	143451
1xGU10	
■ grau	143454

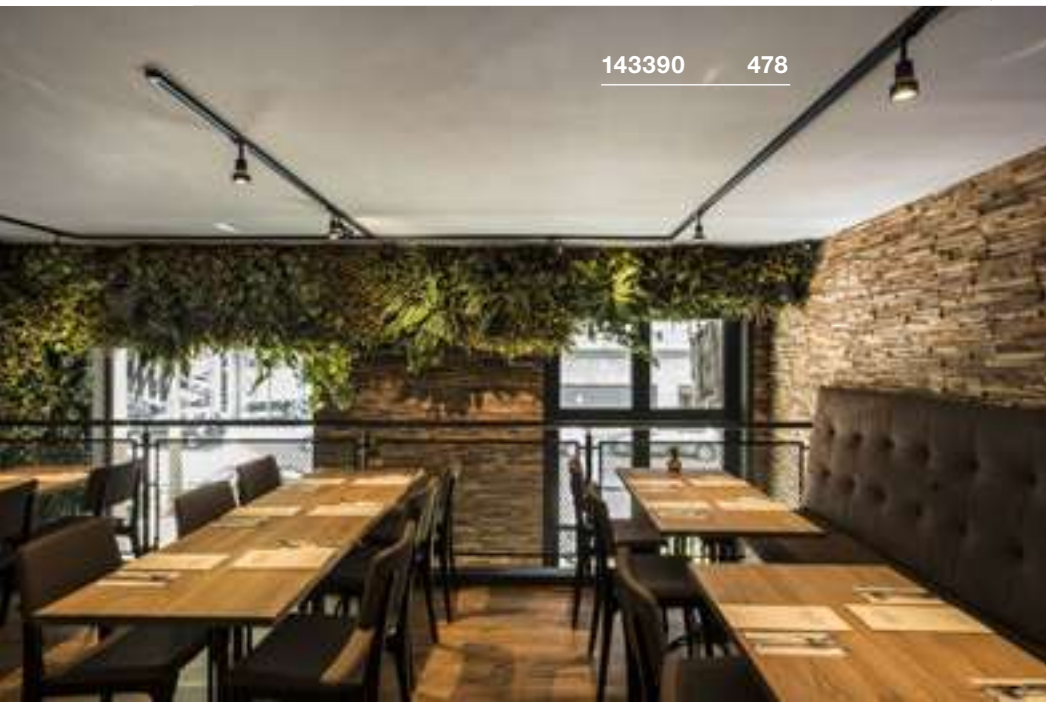

143390 478



143450 478

AVO TRACK

1Ph., QPAR51



SOCKET INSIDE <50 W

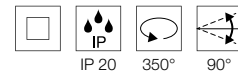
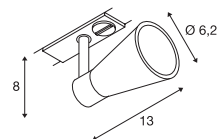

220-240V ~50/60Hz
Material: Stahl



GU10 <50W
Ø: 5 cm



LED GU10 51mm | 6W | 38°
2700K | 450lm | EEK=G
6kWh/1000h



Art. Nr. 1005076

Variante	Art. Nr.
1xGU10	
■ schwarz	144200
1xGU10	
□ weiß	144201
1xGU10	
■ grau	144204

ENOLA C TRACK
1Ph.



ENOLA C TRACK
1Ph.



ENOLA B TRACK
1Ph., QPAR51

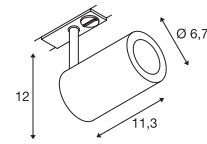
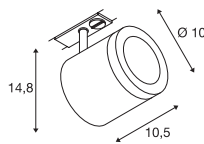
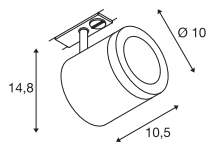
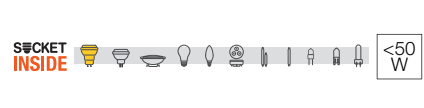
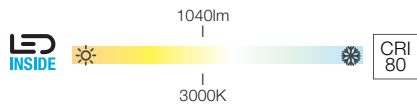
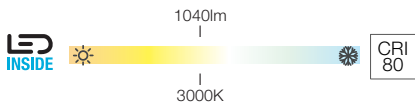
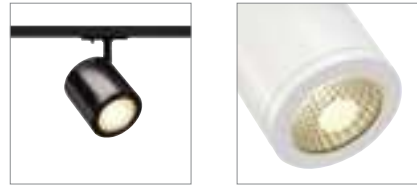

220-240V ~50/60Hz | 500mA
Systemleistung: 11W
Material: Aluminium / Glas

220-240V ~50/60Hz | 500mA
Systemleistung: 11W
Material: Aluminium / Glas

220-240V ~50/60Hz
Material: Aluminium / Stahl

1000711, 143941	1040lm 3000K		

1000712, 143951	1040lm 3000K		

	GU10 <50W Ø: 5 cm L: 6,7 cm
	LED GU10 51mm 6W 38° 3000K 470lm EEK=F 6kWh/1000h

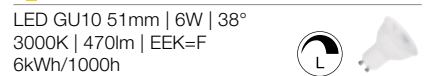

Art. Nr. 1005079

Variante	Art. Nr.
1040lm 3000K CRI80 35°	
■ schwarz	1000711
1040lm 3000K CRI80 35°	
□ weiß	143941

Variante	Art. Nr.
1040lm 3000K CRI80 55°	
■ schwarz	1000712
1040lm 3000K CRI80 55°	
□ weiß	143951

Variante	Art. Nr.
1xGU10	
■ schwarz	1002110
1xGU10	
□ weiß	1002111
1xGU10	
■ grau	1002113

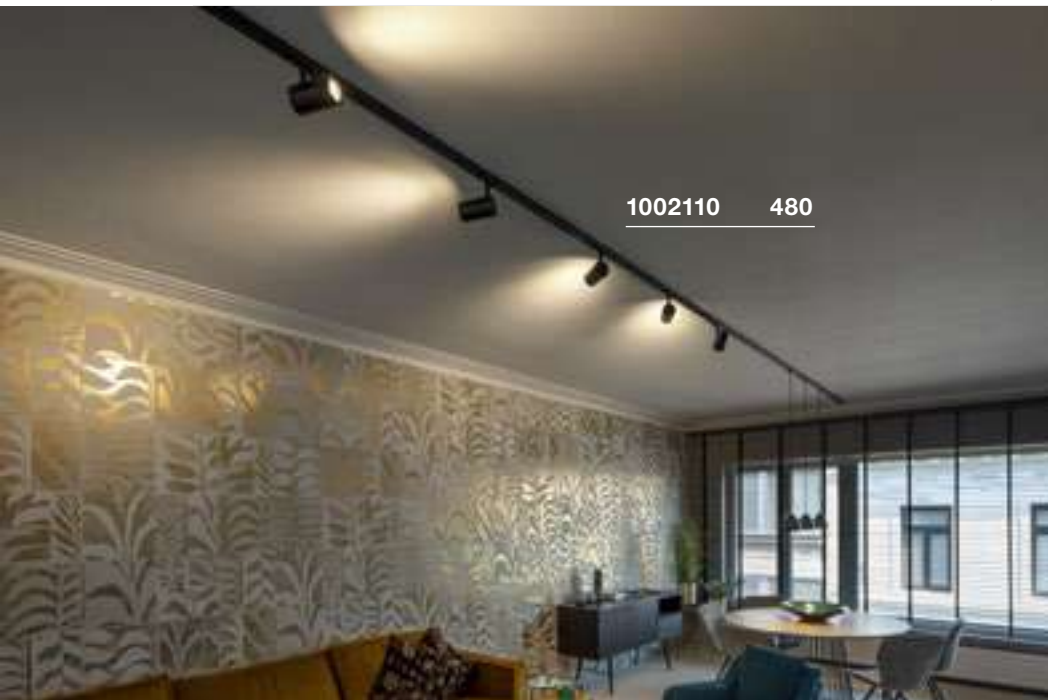

1002110 480



143960 481

ENOLA B
PD, QPAR51



SOCKET INSIDE <50 W

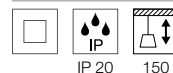
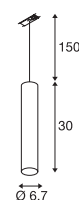

230V ~50Hz
Material: Aluminium / Stahl



GU10 <50W



LED GU10 51mm | 4W | 36°
2700K | 270lm | EEK=G
4kWh/1000h



Art. Nr. 1004972

Variante	Art. Nr.
1xGU10 ■ schwarz	143960
1xGU10 □ weiß	143961
1xGU10 ■ grau	143964

BIMA
1Ph., double, QPAR51

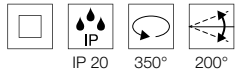
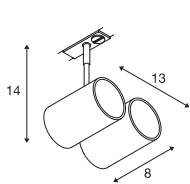

220-240V ~50/60Hz
Material: Aluminium

BIMA
1Ph., single, QPAR51

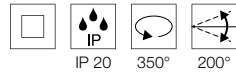
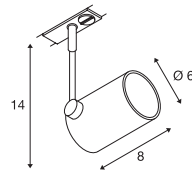

220-240V ~50/60Hz
Material: Aluminium



GU10 <50W
Ø: 5 cm L: 5,7 cm



LED GU10 51mm | 4W | 36°
2700K | 270lm | EEK=G
4kWh/1000h



Art. Nr. 1004972

Variante	Art. Nr.
2xGU10	
■ schwarz	143430
2xGU10	
□ weiß	143431
2xGU10	
■ grau	143432



GU10 <50W
Ø: 5 cm L: 5,7 cm



LED GU10 51mm | 6W | 38°
3000K | 470lm | EEK=F
6kWh/1000h



Art. Nr. 1005080

Variante	Art. Nr.
1xGU10	
■ schwarz	143440
1xGU10	
□ weiß	143441
1xGU10	
■ grau	143442

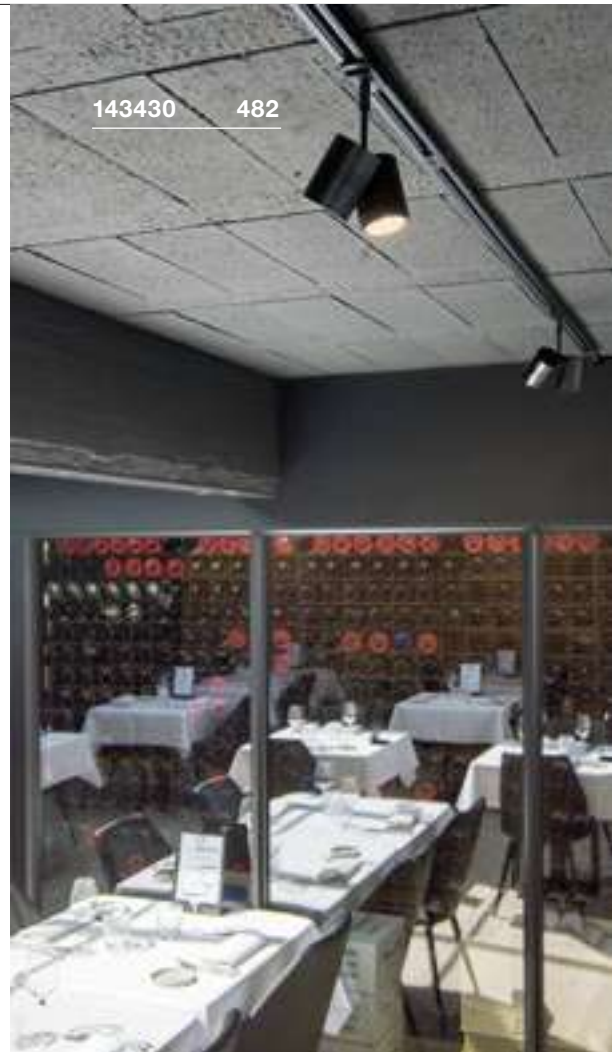

143430 482



143440 482

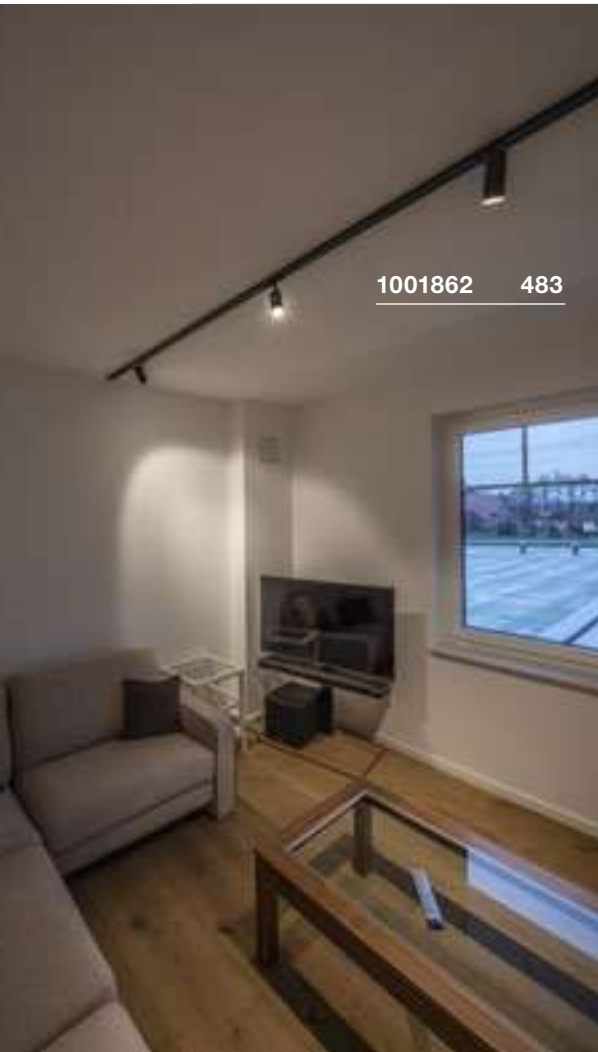

1001862 483

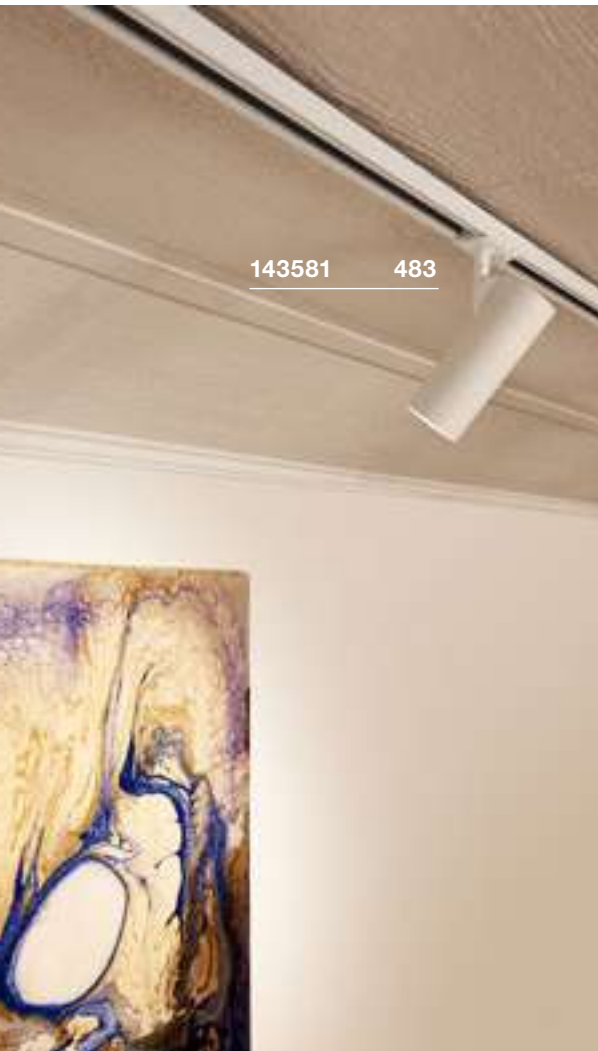

143581 483

NOBLO SPOT
1Ph.

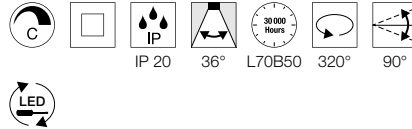
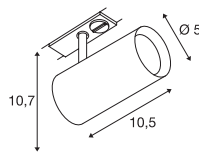
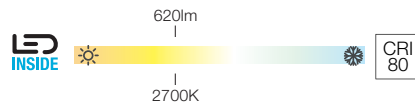
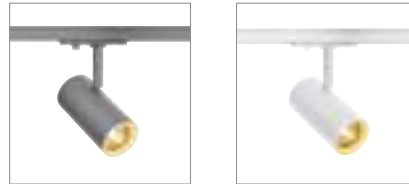

220-240V ~50/60Hz | 350mA
Systemleistung: 7,5W
Material: Aluminium

HELIA 50 TRACK
1Ph.

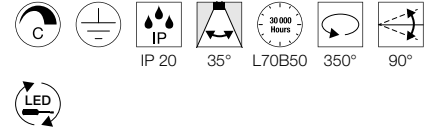
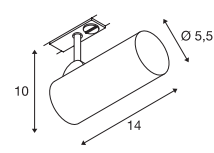
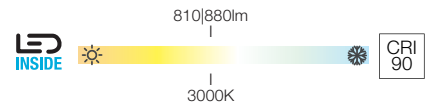
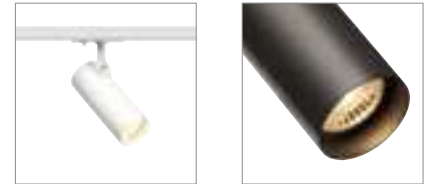

220-240V ~50/60Hz | 500mA
Systemleistung: 11W
Material: Aluminium



1001862, 1001863, 1001864	620lm 2700K	

Variante	Art. Nr.
620lm 2700K CRI80	
■ schwarz	1001862
620lm 2700K CRI90	
□ weiß	1001863
620lm 2700K CRI90	
■ grau	1001864



143580, 143581	810lm 880lm 3000K	

Variante	Art. Nr.
810lm 3000K CRI90	
■ schwarz	143580
880lm 3000K CRI90	
□ weiß	143581

KALU TRACK
1Ph., PHASE



KALU TRACK
1Ph., QPAR111

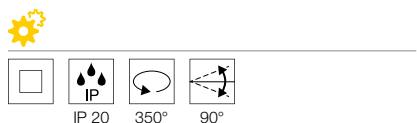
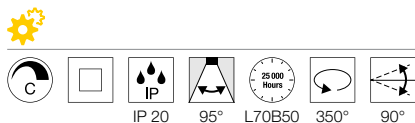
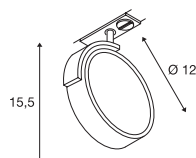
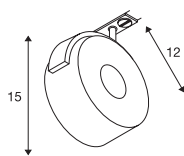
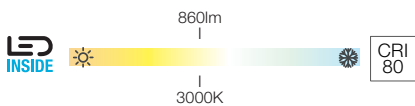

220-240V ~50/60Hz
Systemleistung: 13W
Material: Aluminium

220-240V ~50/60Hz
Material: Aluminium / Kunststoff

1002854, 143731	860lm 3000K	A → G A → E
-----------------	----------------	----------------

GU10 <75W
QPAR111 | 12,5W | 30°
2700K | 950lm | EEK=F
13kWh/1000h
Art. Nr. 1005276

Variante	Art. Nr.
860lm 3000K CRI80	
■ schwarz	1002854
860lm 3000K CRI80	
□ weiß	143731

Variante	Art. Nr.
1xGU10	
■ schwarz	143540
1xGU10	
□ weiß	143541
1xGU10	
■ grau	143544

143731 484



1002854 484





143350 485

EURO SPOT TRACK
1Ph., QPAR51

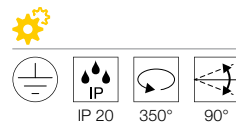
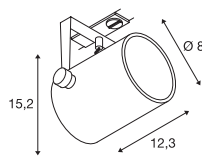
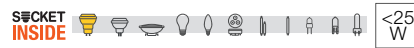

220-240V ~50/60Hz
Material: Aluminium / Glas

GU10 <25W

LED GU10 51mm | 6W | 38°
3000K | 470lm | EEK=F
6kWh/1000h



Art. Nr. 1005079

Variante	Art. Nr.
1xGU10	
■ schwarz	1001861
1xGU10	
□ weiß	143811

ALTRA DICE TRACK
1Ph., QPAR51

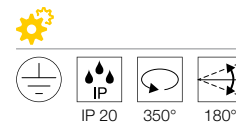
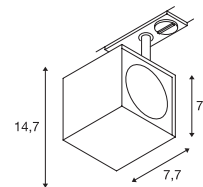

220-240V ~50/60Hz
Material: Aluminium

GU10 <50W

LED GU10 51mm | 4W | 36°
2700K | 270lm | EEK=G
4kWh/1000h



Art. Nr. 1004972

Variante	Art. Nr.
1xGU10	
■ schwarz	143350
1xGU10	
□ weiß	143351
1xGU10	
■ grau	143354

SCHWUNGVOLL UND CHIC.

DAS DEKORATIVE EASYTEC® II
HOCHVOLT-SCHIENEN-SYSTEM.

Mit dem dekorativen Schienensystem können Sie in wenigen Schritten eine individuelle Lichtstimmung erzeugen. Die Trägerschienen aus Aluminium sind in verschiedenen Farben erhältlich und so ideal auf Ihre Raumumgebung abstimmbare.



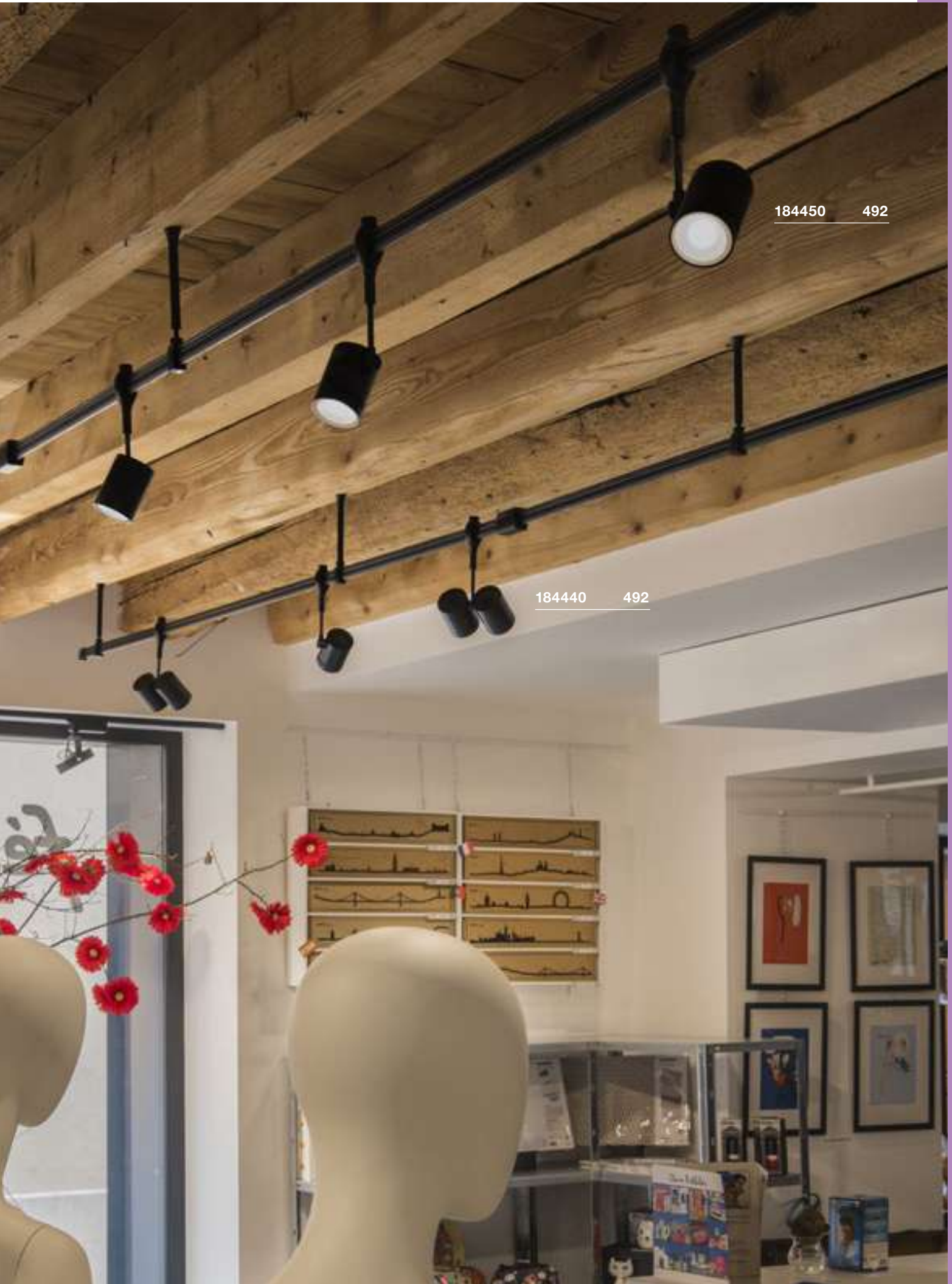

184450 492

184440 492

184440 492





184440 492

184450 492

HOCHVOLT-STROMSCHIENE EASYTEC® II



Passende Stromschienen und Zubehör finden Sie auf der Seite 491



Weitere Leuchten und Varianten finden Sie online unter www.slv.com
 Herstellerangaben unserer Leuchtmittlempfehlungen finden Sie Im Kapitel Leuchtmittel ab Seite 808



185590 495

EASYTEC® II

Schiene mit passendem Zubehör

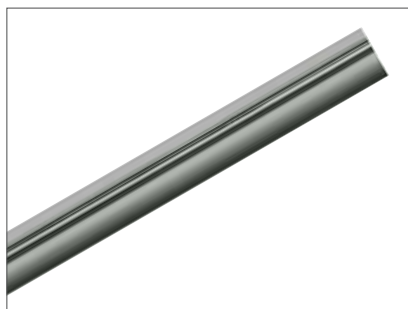

	2 m	2 m
Nennspannung (V)	220-240V ~50/60Hz	220-240V ~50/60Hz
max. Stromstärke (A)	16	16
Material	Aluminium	Aluminium
Farbe	■ schwarz	■ grau
L x B x H (cm)	200 x 1 x 3	200 x 1 x 3
Art. Nr.	184020	184022
EUR		



Flexibler Einspeiser

16A max. | Aluminium
L: 7,5 cm B: 7,5 cm H: 6 cm
Kabellänge 40 cm

■ schwarz Art. Nr. 184004
■ grau 184002



Deckenabhängung verstellbar

Aluminium
Verstellbar von 18 - 26 cm

■ schwarz Art. Nr. 184060
■ grau 184062



Shortbox Einspeiser

16A max. | Aluminium / Stahl
B: 22 cm H: 10,5 cm

■ schwarz Art. Nr. 184010
■ grau 184012



Flexverbinder

16A max. | Kunststoff
L: 21,5 cm B: 3 cm H: 4 cm

■ schwarz Art. Nr. 184300
■ grau 184302



Längsverbinder elektrisch

16A max. | Aluminium

■ schwarz Art. Nr. 184030
■ grau 184032



Endkappen

Kunststoff

■ schwarz Art. Nr. 184140
■ grau 184142



Isolierverbinder

Aluminium

■ schwarz Art. Nr. 184170
■ grau 184172



Easytec® II Pendelleuchtenadapter

3A max. | Aluminium / Kunststoff
L: 13 cm
Max. mechanische Belastung 2 kg

■ schwarz Art. Nr. 184290
■ grau 184292



Flexible Deckenabhängung verstellbar

Aluminium
Verstellbar von 23 - 31 cm

■ schwarz Art. Nr. 184330
■ grau 184332



Biegemaschine für Radien >25 cm

Stahl / Kunststoff

■ grau Art. Nr. 184000

BIMA
EASYTEC® II, single, QPAR51



BIMA
EASYTEC® II, double, QPAR51



KANO
EASYTEC® II, QPAR51

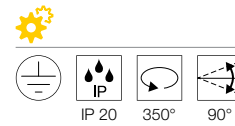
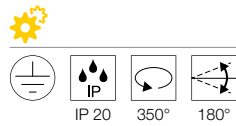
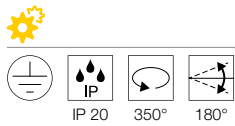
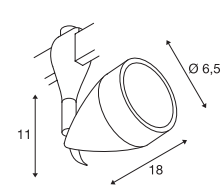
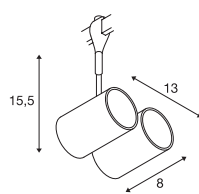
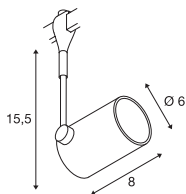
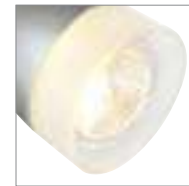

220-240V ~50/60Hz
Material: Aluminium

220-240V ~50/60Hz
Material: Aluminium

220-240V ~50/60Hz
Material: Aluminium / Glas

GU10 <50W
Ø: 5,1 cm L: 5,7 cm

GU10 <50W
Ø: 5,1 cm L: 5,7 cm

GU10 <50W
Ø: 5,1 cm L: 5,7 cm

LED GU10 51mm | 5W | 38°
2700-6500K | 380lm | EEK=F
5kWh/1000h

LED GU10 51mm | 4W | 36°
3000K | 280lm | EEK=F
4kWh/1000h

LED GU10 51mm | 6W | 38°
3000K | 470lm | EEK=F
6kWh/1000h

Art. Nr. 1005311

Art. Nr. 1004973

Art. Nr. 1005079

Variante	Art. Nr.
1xGU10	
■ schwarz	184450
1xGU10	
■ grau	184452

Variante	Art. Nr.
2xGU10	
■ schwarz	184440

Variante	Art. Nr.
1xGU10	
■ grau	184071

184450 492



184440 492



ANILA
EASYTEC® II, QPAR51

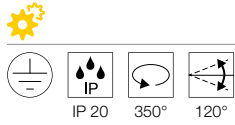
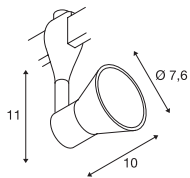

220-240V ~50/60Hz
Material: Aluminium / Glas

GU10 <50W
Ø: 5,1 cm L: 5,7 cm

LED GU10 51mm | 4W | 36°
2700K | 270lm | EEK=G
4kWh/1000h



Art. Nr. 1004972

Variante	Art. Nr.
1xGU10	
■ schwarz	184630
1xGU10	
■ grau	184634

TONGA®
EASYTEC® II, PD, E14

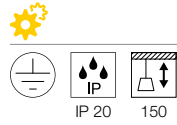
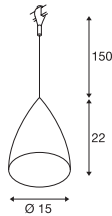
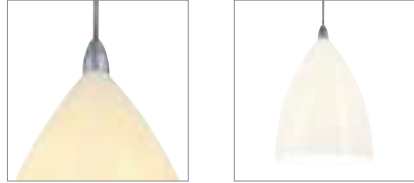

220-240V ~50/60Hz
Material: Aluminium / Glas

E14 <60W
Ø: 5 cm L: 13 cm

C35 | 4.2W | 320°
2700K | 380lm | EEK=F
5kWh/1000h



Art. Nr. 1005284

Variante	Art. Nr.
1xE14	
■ schwarz	184530
1xE14	
■ grau	184534



184534 494



185590 495



185590 495

LIGHT EYE® 150
EASYTEC® II, PD, QPAR111



LIGHT EYE® 150 TRACK
EASYTEC® II, QPAR111

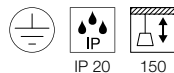
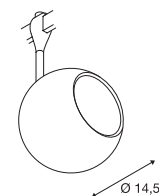
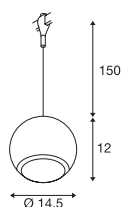

220-240V ~50/60Hz
Material: Stahl

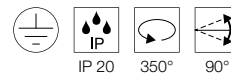

220-240V ~50/60Hz
Material: Stahl



GU10 <75W



GU10 <75W



QPAR111 | 12.5W | 30°
2700K | 950lm | EEK=F
13kWh/1000h

Art. Nr. 1005276



QPAR111 | 12.5W | 30°
2700K | 950lm | EEK=F
13kWh/1000h

Art. Nr. 1005276

Variante	Art. Nr.
1xGU10	
■ schwarz	184590
1xGU10	
■ schwarz/chrom	185590

Variante	Art. Nr.
1xGU10	
■ schwarz/chrom	185580

DETAILVERLIEBT.

NIEDERVOLT-SEILSYSTEM SETZT AKZENTE.

Licht hilft dabei, Räumen Atmosphäre zu geben. Überall dort, wo es gemütlich und gleichzeitig professionell sein soll, sind Niedervolt-Seilsysteme die passende Lösung – denn sie bieten Raum für individuelle Beleuchtungskonzepte und schaffen Gemütlichkeit.





1002862 504



139112 504



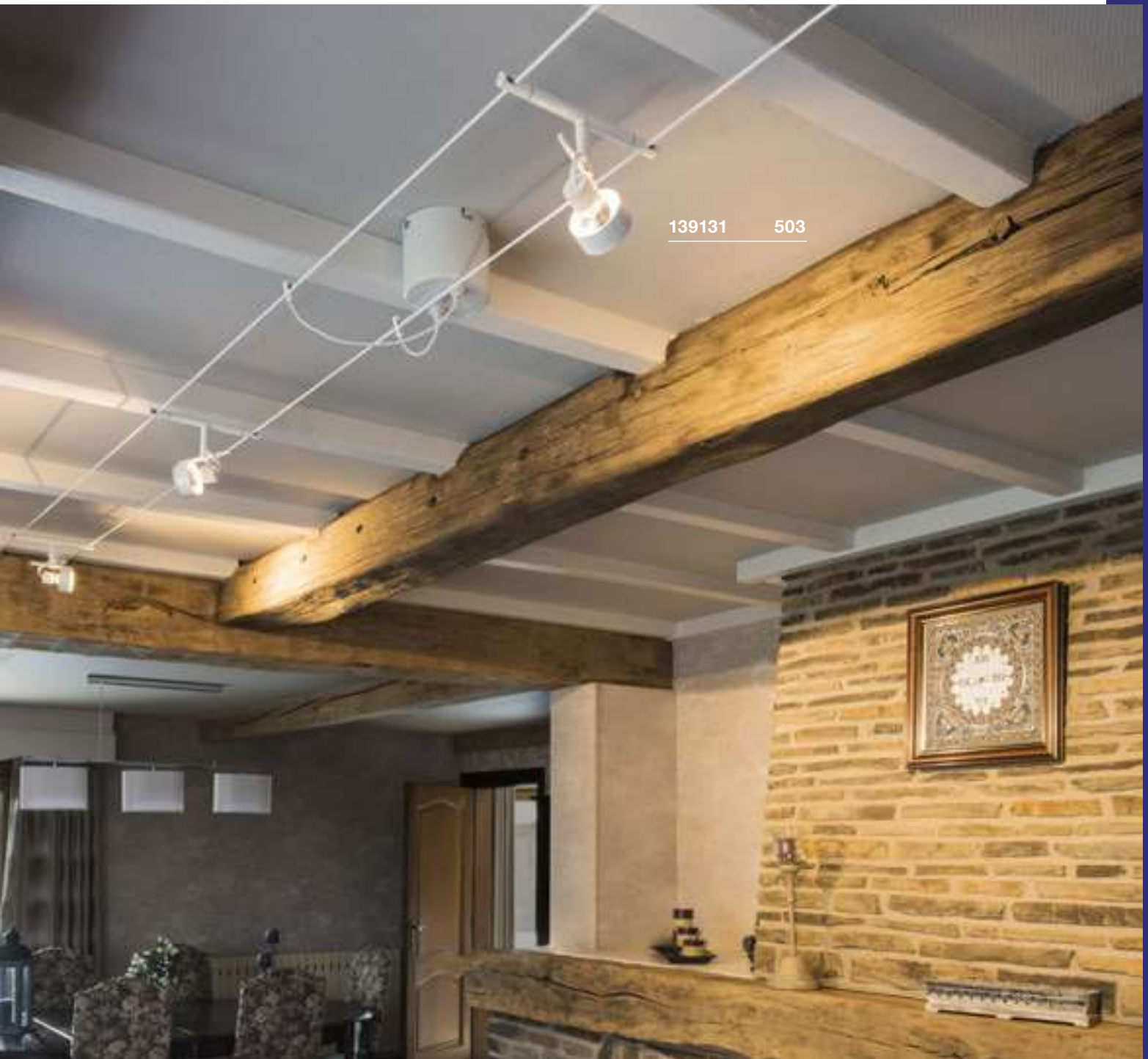

139131 503

NIEDERVOLT-SEILSYSTEM

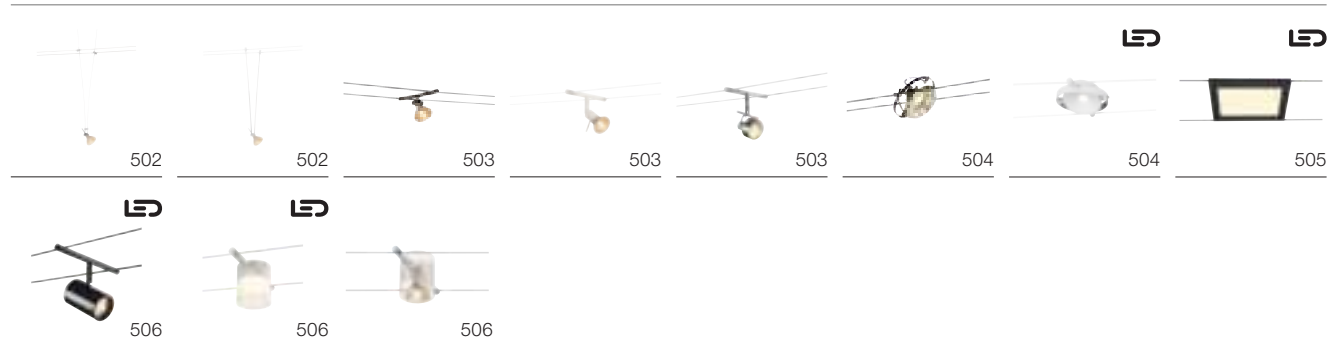

Passendes Zubehör finden Sie auf den Seiten 500-501

i Weitere Leuchten und Varianten finden Sie online unter www.slv.com
 Herstellerangaben unserer Leuchtmittlempfehlungen finden Sie Im Kapitel Leuchtmittel ab Seite 808

TENSEO

Niedervolt-Seilsystem mit passendem Zubehör



TENSEO 4 mm ²	10 m	10 m	10 m	20 m	20 m	20 m
Spannung max.	48V	48V	48V	48V	48V	48V
Strombelastung max.	25A	25A	25A	25A	25A	25A
Material	Kupfer / Kunststoff	Kupfer / Kunststoff	Kupfer / Kunststoff	Kupfer / Kunststoff	Kupfer / Kunststoff	Kupfer / Kunststoff
Farbe	■ schwarz	□ weiß	□ transparent	■ schwarz	□ weiß	□ transparent
Durchmesser (cm)	0,4	0,4	0,4	0,4	0,4	0,4
Länge (cm)	1000	1000	1000	2000	2000	2000
Art. Nr.	1002602	1002603	1002604	139030	139031	139024
EUR						

TENSEO 4 mm ²	100 m	100 m	10 m
Spannung max.	48V	48V	48V
Strombelastung max.	25A	25A	25A
Material	Kupfer / Kunststoff	Kupfer / Kunststoff	Kupfer / Kunststoff
Farbe	■ schwarz	□ weiß	□ transparent
Durchmesser (cm)	0,4	0,4	0,4
Länge (cm)	10000	10000	10000
Art. Nr.	139040	139041	139004
EUR			

TENSEO 6 mm ²	20 m	20 m	20 m	100 m	100 m	100 m
Spannung max.	48V	48V	48V	48V	48V	48V
Strombelastung max.	25A	25A	25A	25A	25A	25A
Material	Kupfer / Kunststoff	Kupfer / Kunststoff	Kupfer / Kunststoff	Kupfer / Kunststoff	Kupfer / Kunststoff	Kupfer / Kunststoff
Farbe	■ schwarz	□ weiß	□ transparent	■ schwarz	□ weiß	□ transparent
Durchmesser (cm)	0,6	0,6	0,6	0,6	0,6	0,6
Länge (cm)	2000	2000	2000	10000	10000	10000
Art. Nr.	139050	139051	139026	139060	139061	139006
EUR						

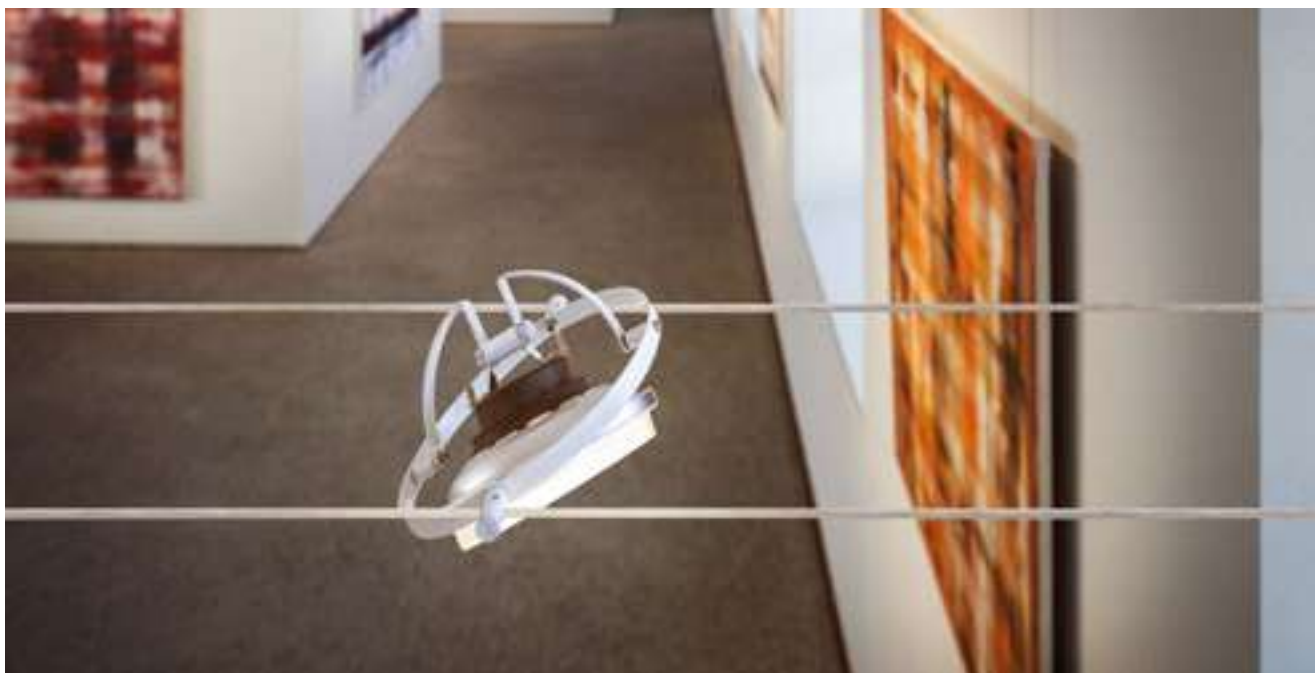

Transformator TENSEO | 12V AC
 50VA konventionell | Stahl / Messing
 H: 11 cm Ø: 11,1 cm
 ■ schwarz Art. Nr. 1002691
 □ weiß 1002692
 ■ chrom 1002693



Wand/Deckenhalter, flexibel
 Stahl / Messing
 H: 11,5 cm Ø: 5 cm
 ■ schwarz Art. Nr. 186310
 □ weiß 186311
 ■ chrom 186312



Transformator TENSEO | 12V AC
 105VA konventionell | Stahl / Messing
 H: 11 cm Ø: 11,1 cm
 □ weiß Art. Nr. 138981
 ■ chrom 138982



Umlenker
 Stahl / Messing
 H: 16 cm Ø: 5 cm
 ■ schwarz Art. Nr. 186640
 □ weiß 186641
 ■ chrom 186642



Transformator TENSEO | 12V AC
 210VA konventionell | Stahl / Messing
 H: 11 cm Ø: 13,5 cm
 □ weiß Art. Nr. 138991
 ■ chrom 138992



Einspeiser
 25A max. | Messing
 H: 1,8 cm Ø: 1 cm
 ■ schwarz Art. Nr. 186350
 □ weiß 186351
 ■ chrom 186352



Seilspanner
 25A max. | Messing
 H: 11 cm Ø: 1 cm
 ■ schwarz Art. Nr. 181530
 □ weiß 181531
 ■ chrom 181532



Isolierverbinder
 25A max. | Aluminium / Kunststoff
 L: 6,4 cm Ø: 1 cm
 ■ schwarz Art. Nr. 186360
 □ weiß 186361
 ■ chrom 186362

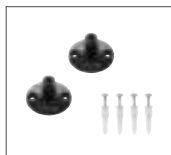

Wandhalter
 Stahl / Messing
 L: 3 cm Ø: 5 cm
 ■ schwarz Art. Nr. 186300
 □ weiß 186301
 ■ chrom 186302



Abstandhalter TENSEO
 Aluminium
 H: 9 cm Ø: 1.25 cm
 ■ schwarz Art. Nr. 1002700
 □ weiß 1002701
 ■ chrom 1002702



Deckenhalter
 Stahl / Messing
 H: 6 cm Ø: 5 cm
 ■ schwarz Art. Nr. 186330
 □ weiß 186331
 ■ chrom 186332



Abstandhalter elektrisch
 25A max. | Messing
 H: 9 cm Ø: 1.25 cm
 ■ schwarz Art. Nr. 1002703
 □ weiß 1002704
 ■ chrom 1002705



Deckenhalter
 Stahl / Messing
 H: 16 cm Ø: 5 cm
 ■ schwarz Art. Nr. 186340
 □ weiß 186341
 ■ chrom 186342

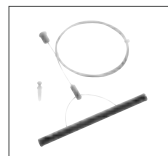

Seilabhängeset
 Stahl / Aluminium
 B: 18,6 cm Ø: 1.25 cm L: 2000 cm
 ■ schwarz Art. Nr. 1002697
 □ weiß 1002698
 ■ chrom 1002699

ASMARA
LV, QR-C51

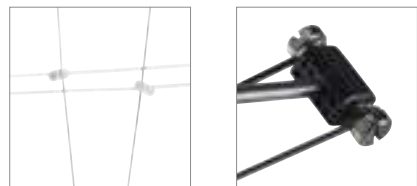
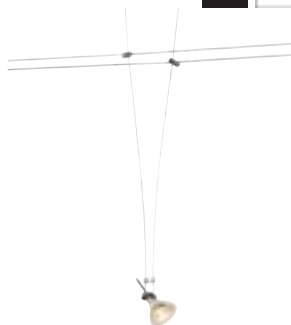

SOCKET INSIDE <35 W

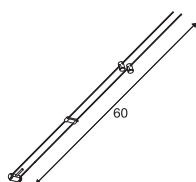

12V ~50Hz
Material: Edelstahl

GX5,3 <35W

LED GU5,3 | 5,5W | 36°
2700K | 450lm | EEK=G
7kWh/1000h



Art. Nr. 1001574

Variante	Art. Nr.
1xGX5,3	
■ schwarz	139070
1xGX5,3	
□ weiß	139071
1xGX5,3	
■ chrom	139072

TELESKOP
LV, QR-C51

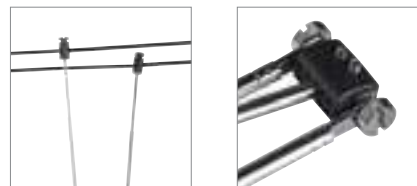

SOCKET INSIDE <20 W

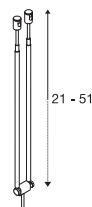

12V ~50Hz
Material: Stahl / Messing

• Teleskop von 21-51 cm einstellbar

GX5,3 <20W

LED GU5,3 | 5,5W | 36°
3000K | 450lm | EEK=G
7kWh/1000h



Art. Nr. 1001575

Variante	Art. Nr.
1xGX5,3	
■ schwarz	139080
1xGX5,3	
□ weiß	139081
1xGX5,3	
■ chrom	139082

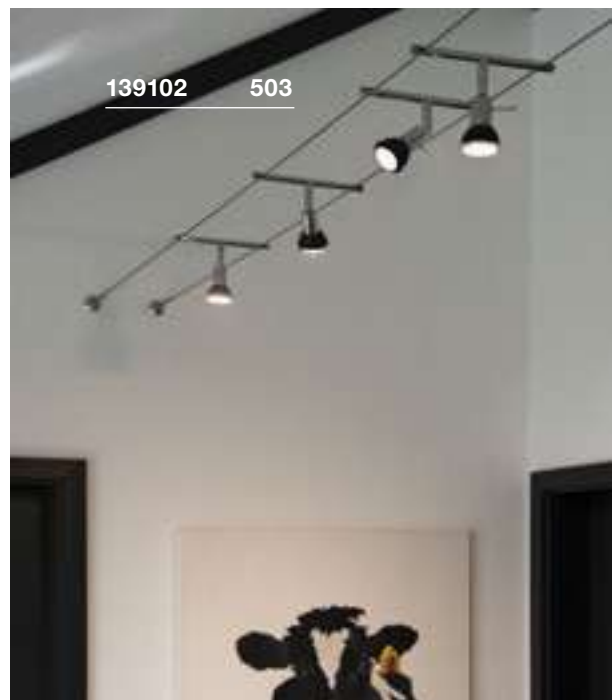



COSMIC
LV, QR-C51

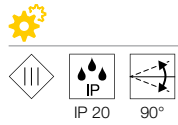
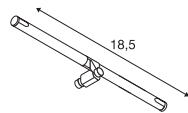
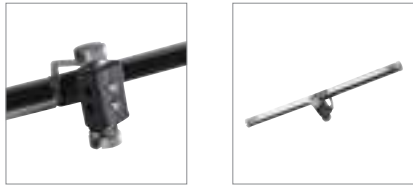

12V ~50Hz
Material: Stahl / Messing

- Exkl. Leuchtmittel

GX5,3 <35W

LED GU5,3 | 5,5W | 36°
2700K | 450lm | EEK=G
7kWh/1000h



Art. Nr. 1001574

Variante	Art. Nr.
1xGX5,3	
■ schwarz	139090
1xGX5,3	
□ weiß	139091
1xGX5,3	
■ chrom	139092

SYROS
LV, QR-C51

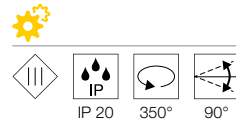
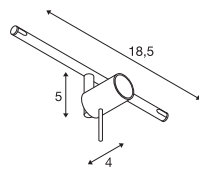
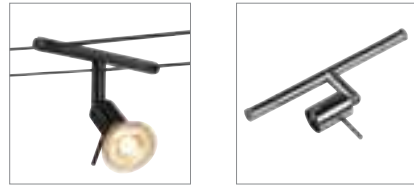

12V ~50Hz
Material: Stahl / Messing

GX5,3 <35W

LED GU5,3 | 5,5W | 36°
3000K | 450lm | EEK=G
7kWh/1000h



Art. Nr. 1001575

Variante	Art. Nr.
1xGX5,3	
■ schwarz	139100
1xGX5,3	
□ weiß	139101
1xGX5,3	
■ chrom	139102

SALUNA
LV, QR-C51

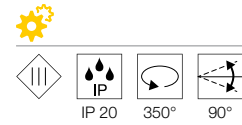
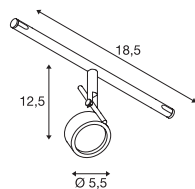
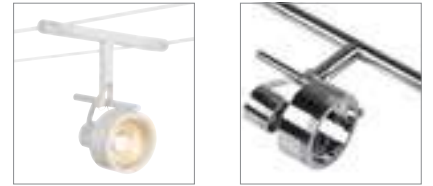

12V ~50Hz
Material: Stahl / Messing

GX5,3 <35W

LED GU5,3 | 5,5W | 36°
2700K | 450lm | EEK=G
7kWh/1000h



Art. Nr. 1001574

Variante	Art. Nr.
1xGX5,3	
■ schwarz	139130
1xGX5,3	
□ weiß	139131
1xGX5,3	
■ chrom	139132

ORBIT
LV, QR111

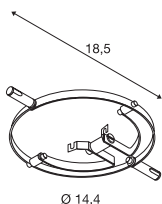

12V ~50Hz
Material: Stahl



G53 <math><50\text{ W}</math>



LED G53 | 15W | 40°
2700K | 800lm | EEK=G
17kWh/1000h



Art. Nr. 560232

Variante	Art. Nr.
1xG53 ■ schwarz	139110
1xG53 □ weiß	139111
1xG53 ■ chrom	139112

DURNO

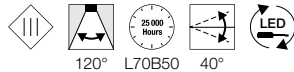
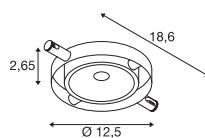
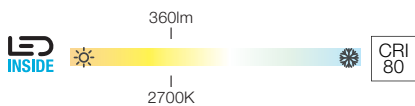
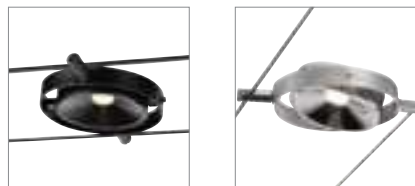

12V ~50Hz
Systemleistung: 6W
Material: Aluminium / Edelstahl



IV	Light Spectrum	A → G
1002861, 1002862, 1002863	360lm 2700K	A → G F

Variante	Art. Nr.
360lm 2700K CRI80 ■ schwarz	1002861
360lm 2700K CRI80 □ weiß	1002862
360lm 2700K CRI80 ■ glänzend chrom / glänzend edelstahl	1002863



139111

504



1002862 504

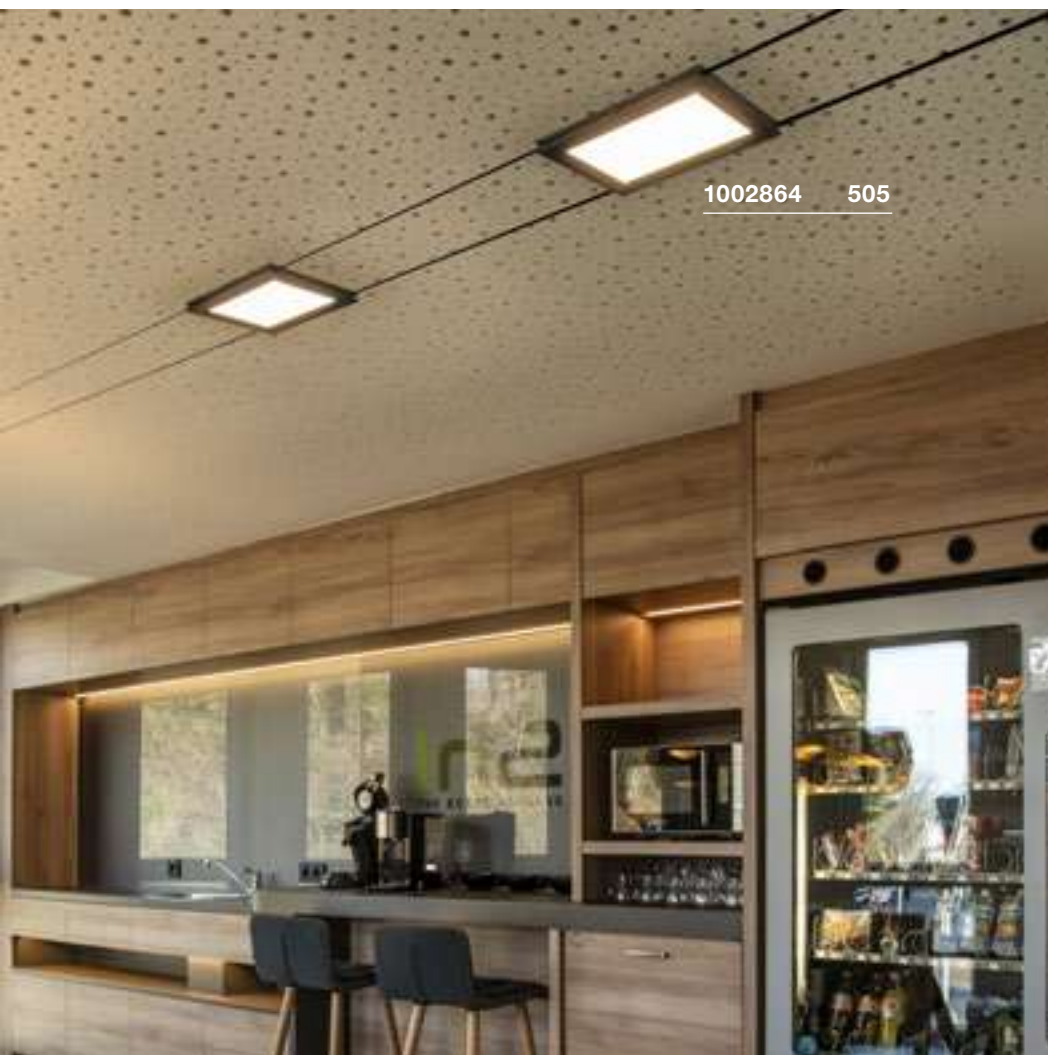

1002864 505

PLYTTA

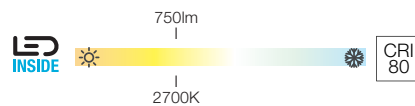
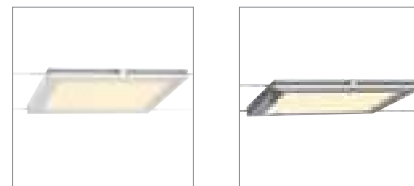

CRI 80

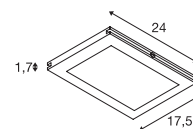

120° L70B50

12V ~50Hz
Systemleistung: 9,8W
Material: Kunststoff / Aluminium



1002864, 1002865, 1002866	750lm 2700K	

Variante	Art. Nr.
750lm 2700K CRI80 ■ schwarz	1002864
750lm 2700K CRI90 □ weiß	1002865
750lm 2700K CRI90 ■ chrom	1002866

NOBLO SPOT
LV, Rope Track

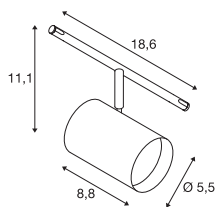
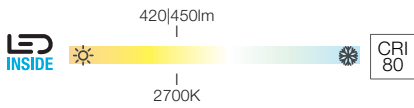
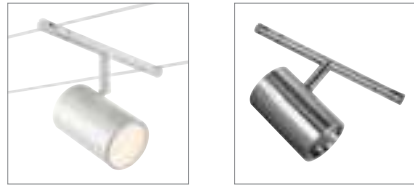

IP 20 36° L70B50 340° 90°

12V ~50Hz
Systemleistung: 8,5W
Material: Aluminium / Polymethylacrylat (PMMA)

COMET LED
LV

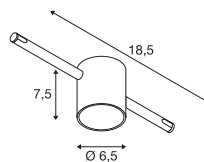
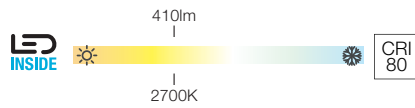

IP 20 120° L70B50

12V ~50Hz
Systemleistung: 6,6W
Material: Aluminium / Glas

COMET
LV, QR-C51

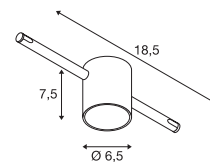
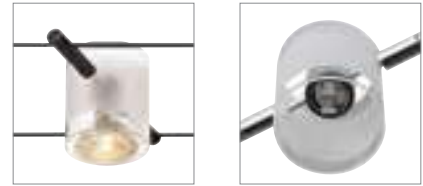

IP 20

12V ~50Hz
Material: Messing / Messing

1002694, 1002695, 1002696	420lm 450lm 2700K	

1002688, 1002689, 1002690	410lm 2700K	

	GU5,3 <50W
	LED GU5,3 5,5W 36° 2700K 450lm EEK=G 7kWh/1000h
Art. Nr.	1001574

Variante	Art. Nr.
420lm 2700K CRI80	
schwarz	1002694
450lm 2700K CRI80	
weiß	1002695
450lm 2700K CRI80	
chrom	1002696

Variante	Art. Nr.
410lm 2700K CRI80	
schwarz / gefrostet	1002688
410lm 2700K CRI80	
weiß / gefrostet	1002689
410lm 2700K CRI80	
chrom / gefrostet	1002690

Variante	Art. Nr.
1xGU5,3	
schwarz	139120
1xGU5,3	
weiß	139121
1xGU5,3	
chrom	139122



1002695 506



1002690 506

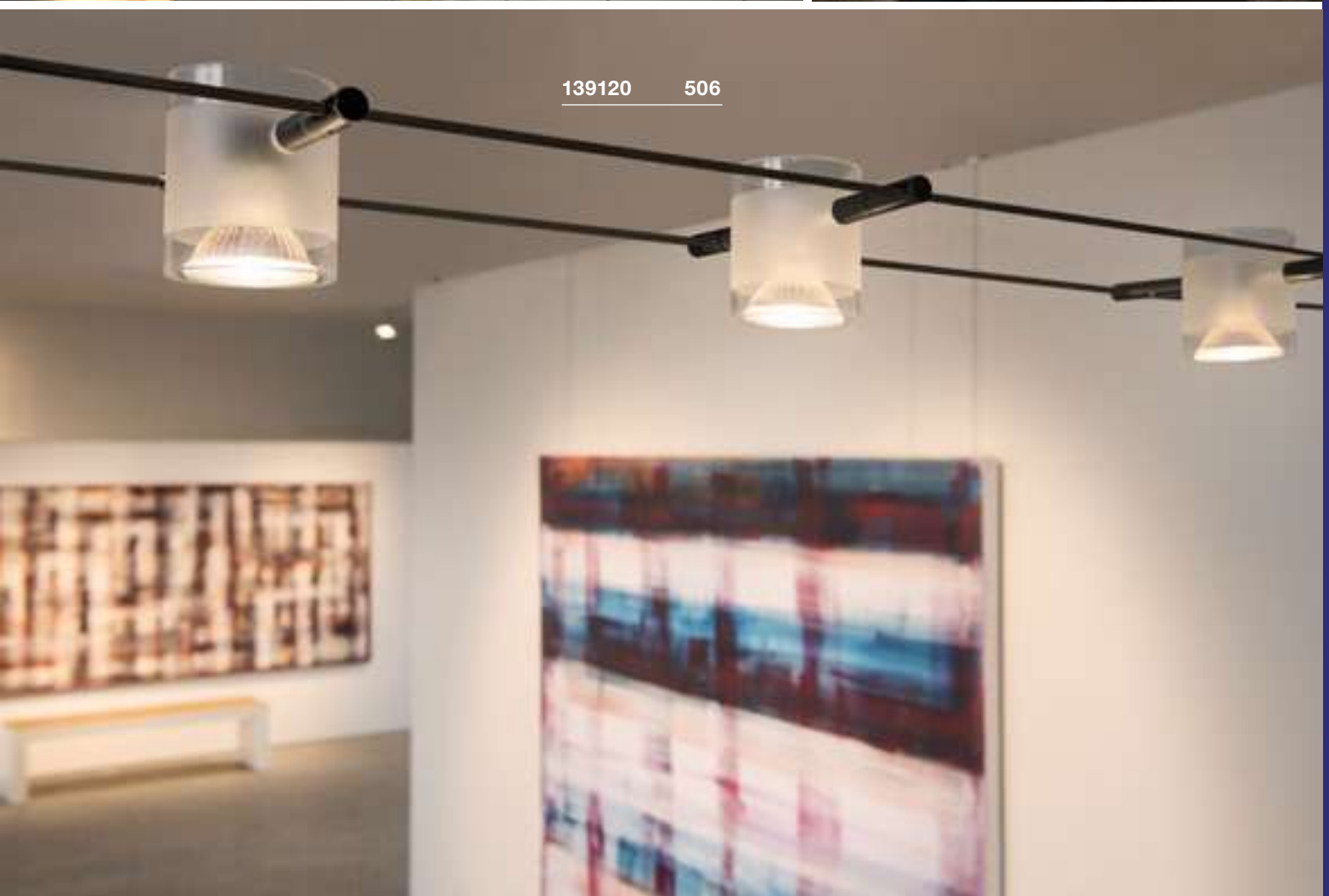

139120 506

WEISEN DEN WEG.

MOBILE LEUCHTEN UND STANDLEUCHTEN.

Jetzt muss niemand mehr im Dunkeln tappen: Mobile Leuchten und Standleuchten sind ein beliebtes Gestaltungselement für Außenanlagen und bieten dabei Orientierung und Sicherheit. Die besondere Optik verdanken die Outdoor-Leuchten ihren hochwertigen Materialien, den modernen Formen und innovativen Technologien.





1006184 521



1001823 527



MOBILE LEUCHTEN UND STANDLEUCHTEN



 Weitere Leuchten und Varianten finden Sie online unter www.slv.com
 Herstellerangaben unserer Leuchtmittlempfehlungen finden Sie Im Kapitel Leuchtmittel ab Seite 808

ESKINA FRAME 45
Pole, single



ESKINA FRAME 75
Pole, single



ESKINA FRAME 75
Pole, double

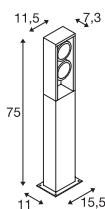
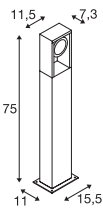
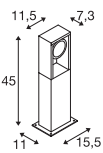
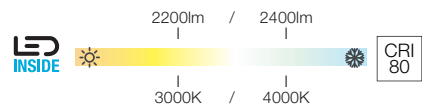
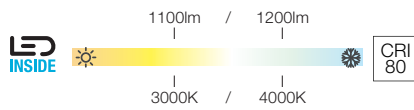
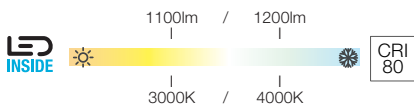

220-240V ~50/60Hz | 350mA
Systemleistung: 15W
Material: Aluminium

220-240V ~50/60Hz | 350mA
Systemleistung: 15W
Material: Aluminium

220-240V ~50/60Hz | 700mA
Systemleistung: 27W
Material: Aluminium

Spot	1100/1200lm 3000/4000K	

Spot	1100/1200lm 3000/4000K	

Spot 1/Spot 2	1100/1200lm 3000/4000K	

Verbindungsbox IP68, 3-polig
Art. Nr. 228730

Verbindungsbox IP68, 3-polig
Art. Nr. 228730

Verbindungsbox IP68, 3-polig
Art. Nr. 228730

Variante	Art. Nr.
1100/1200lm 3000/4000K CRI80 ■ anthrazit	1004749

Variante	Art. Nr.
1100/1200lm 3000/4000K CRI80 ■ anthrazit	1004750

Variante	Art. Nr.
Spot 1: 1100/1200lm 3000/4000K CRI80 Spot 2: 1100/1200lm 3000/4000K CRI80 ■ anthrazit	1004751



1004751 512

ESKINA FRAME 125
Pole, double



NEW



2200lm / 2400lm

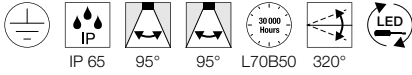
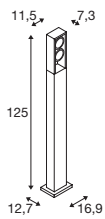

220-240V ~50/60Hz | 700mA
Systemleistung: 27W
Material: Aluminium



		A → G
Spot 1/Spot 2	1100/1200lm 3000/4000K	A G D



Verbindungsbox IP68, 3-polig
Art. Nr. **228730**



Variante	Art. Nr.
Spot 1: 1100/1200lm 3000/4000K CRI80	
Spot 2: 1100/1200lm 3000/4000K CRI80	
■ anthrazit	1005439 ■



1005439 514



1005440 515



ESKINA FRAME 175
Pole, double



NEW

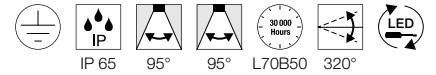
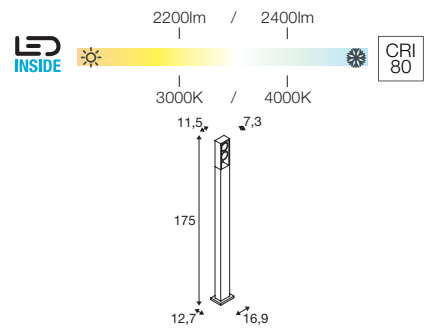

220-240V ~50/60Hz | 700mA
Systemleistung: 27W
Material: Aluminium



Spot 1/Spot 2	1100/1200lm 3000/4000K	



Verbindungsbox IP68, 3-polig
Art. Nr. 228730



Variante	Art. Nr.
Spot 1: 1100/1200lm 3000/4000K CRI80	
Spot 2: 1100/1200lm 3000/4000K CRI80	
anthrazit	1005440

ESKINA 30
Pole



ESKINA 80
Pole

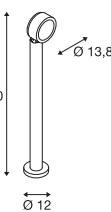
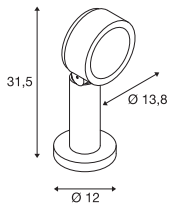
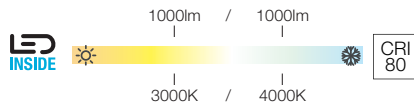
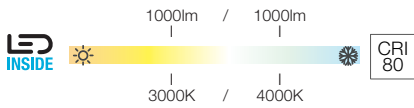

220-240V ~50/60Hz | 350mA
Systemleistung: 14,5W
Material: Aluminium

220-240V ~50/60Hz | 350mA
Systemleistung: 14,5W
Material: Aluminium

- IP44 Schutzkontaktstecker

1002906	1000lm 3000/4000K	

1002907	1000lm 3000/4000K	

Erdspieß
Art. Nr. 230060

Erdspieß
Art. Nr. 230060

Variante	Art. Nr.
1000lm 3000/4000K CRI80	
anthrazit	1002906

Variante	Art. Nr.
1000lm 3000/4000K CRI80	
anthrazit	1002907



1002906 516

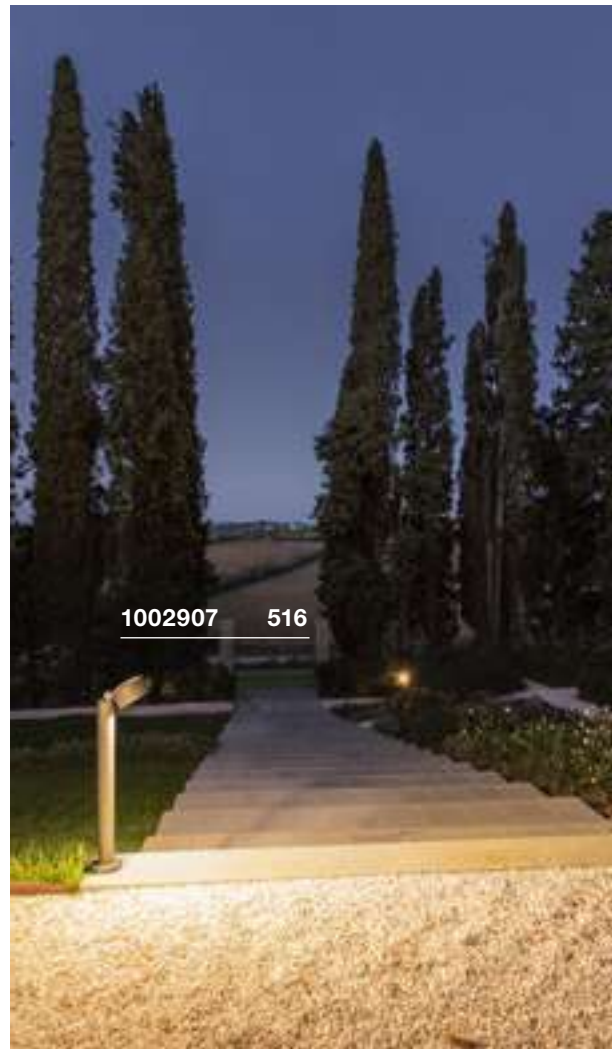

1002907 516



232115 517



232125 517

LOGS 40 Pole



LOGS 70 Pole

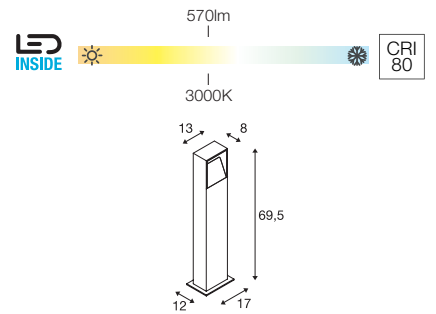
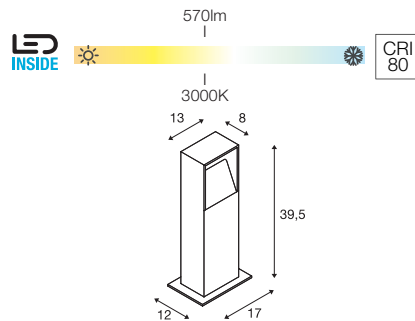

IP 44 L70B50

IP 44 L70B50

100-240V ~50/60Hz | 500mA
Systemleistung: 10W
Material: Aluminium

100-240V ~50/60Hz | 500mA
Systemleistung: 10W
Material: Aluminium

232115	570lm 3000K	

232125	570lm 3000K	

-
- Verbindungsbox IP68, 3-polig
Art. Nr. 228730
 - Schraubenset
Art. Nr. 228754
 - Erdspieß
Art. Nr. 231230
 - Betonanker
Art. Nr. 232119

-
- Verbindungsbox IP68, 3-polig
Art. Nr. 228730
 - Schraubenset
Art. Nr. 228754
 - Erdspieß
Art. Nr. 231230
 - Betonanker
Art. Nr. 232119

Variante	Art. Nr.
570lm 3000K CRI80 ■ anthrazit	232115

Variante	Art. Nr.
570lm 3000K CRI80 ■ anthrazit	232125

GRAFIT 30
Pole, rund, E27



NEW

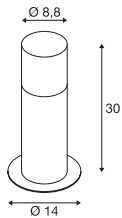

220-240V ~50/60Hz
Material: Aluminium / Acryl

- Offenes Kabelende

GRAFIT 60
Pole, rund, E27



NEW

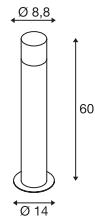

220-240V ~50/60Hz
Material: Aluminium / Acryl

- Offenes Kabelende

GRAFIT 90
Pole, rund, E27



NEW

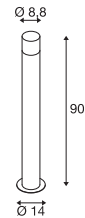

220-240V ~50/60Hz
Material: Aluminium / Acryl

- Offenes Kabelende



E27 <11W
Ø: 6 cm L: 11,5 cm



LED E27 | 7,5W | 320°
2700K | 700lm | EEK=F
8kWh/1000h



Art. Nr. 1005304



■ Verbindungsbox IP68, 3-polig
Art. Nr. 228730



E27 <11W
Ø: 6 cm L: 11,5 cm



LED E27 | 7,5W | 320°
2700K | 800lm | EEK=F
8kWh/1000h



Art. Nr. 1005303



■ Verbindungsbox IP68, 3-polig
Art. Nr. 228730



E27 <11W
Ø: 6 cm L: 11,5 cm



LED E27 | 8W | 240°
3000K | 880lm | EEK=E
8kWh/1000h



Art. Nr. 1005289



■ Verbindungsbox IP68, 3-polig
Art. Nr. 228730



Variante	Art. Nr.
1xE27	
■ anthrazit	1006180 ■

Variante	Art. Nr.
1xE27	
■ anthrazit	1006181 ■

Variante	Art. Nr.
1xE27	
■ anthrazit	1006182 ■





231225 521



GRAFIT 30
Pole, E27

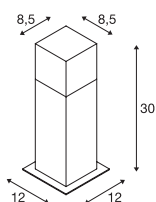

220-240V ~50/60Hz
Material: Aluminium / Kunststoff

- Offenes Kabelende

GRAFIT 60
Pole, E27

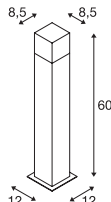

220-240V ~50/60Hz
Material: Aluminium / Kunststoff

- Offenes Kabelende

GRAFIT 90
Pole, E27



NEW

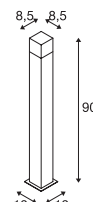

220-240V ~50/60Hz
Material: Aluminium / Acryl

- Offenes Kabelende



E27 <11W
Ø: 6 cm L: 11,5 cm



LED E27 | 8W | 240°
4000K | 880lm | EEK=E
8kWh/1000h



Art. Nr. 1005290



■ Verbindungsbox IP68, 3-polig

Art. Nr. 228730

■ Schraubenset

Art. Nr. 228754

■ Erdspieß

Art. Nr. 231230



E27 <11W
Ø: 6 cm L: 11,5 cm



LED E27 | 9W | 220°
2700K | 800lm | EEK=F
9kWh/1000h



Art. Nr. 1005301



■ Verbindungsbox IP68, 3-polig

Art. Nr. 228730

■ Schraubenset

Art. Nr. 228754

■ Erdspieß

Art. Nr. 231230



E27 <11W
Ø: 6 cm L: 11,5 cm



LED E27 | 13,2W | 220°
2700K | 1300lm | EEK=F
13kWh/1000h



Art. Nr. 1005302



■ Verbindungsbox IP68, 3-polig

Art. Nr. 228730

■ Schraubenset

Art. Nr. 228754

■ Erdspieß

Art. Nr. 231230



Variante	Art. Nr.
1xE27	
■ anthrazit	231215

Variante	Art. Nr.
1xE27	
■ anthrazit	231225

Variante	Art. Nr.
1xE27	
■ anthrazit	1006184

QUADRULO
FL



NEW

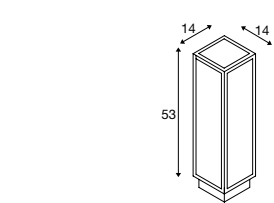
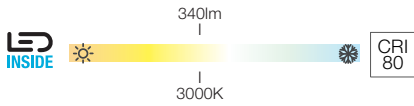
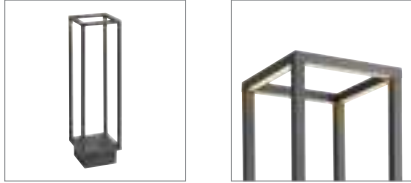

100-277V ~50/60Hz | 480mA
Systemleistung: 7W
Material: Aluminium / Acryl

- IP Anschlussbox



		A → G
1005442	340lm 3000K	A G E

Variante	Art. Nr.
340lm 3000K CRI80	
■ anthrazit / weiß	1005442 ■





1005442 522

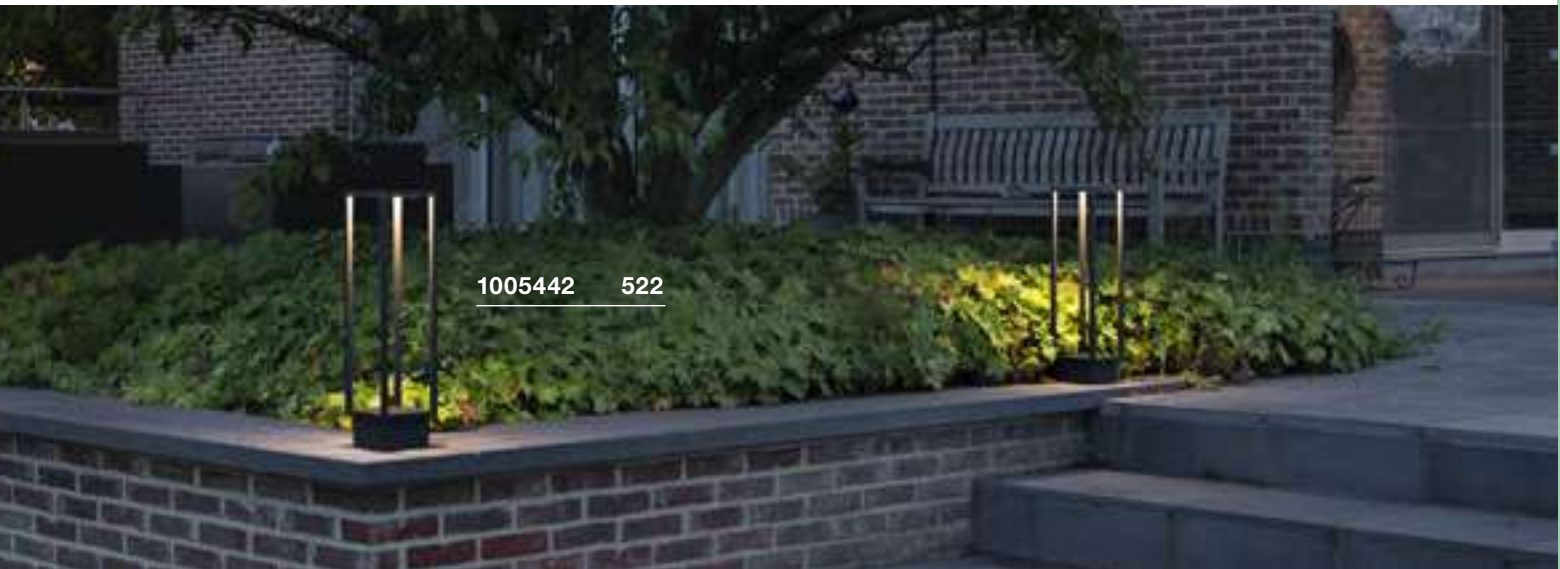

1005442 522

RUSTY® SLOT 50 Pole



RUSTY® SLOT 80 Pole



RUSTY® SLOT 50 Pole, E27

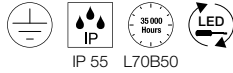
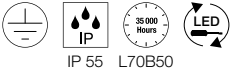
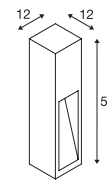
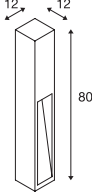
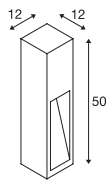
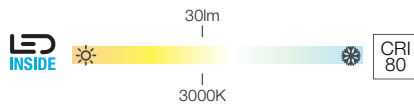
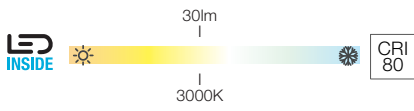

220-240V ~50/60Hz
Systemleistung: 9W
Material: FeCSi-Stahl / Polycarbonat (PC)

220-240V ~50/60Hz
Systemleistung: 9W
Material: FeCSi-Stahl / Polycarbonat (PC)

220-240V ~50/60Hz
Material: FeCSi-Stahl / Polycarbonat (PC)

- Offenes Kabelende

- Offenes Kabelende

- Offenes Kabelende



233447	30lm 3000K	

233457	30lm 3000K	

E27 <11W
Ø: 4,8 cm L: 13,9 cm



LED E27 | 8W | 240°
3000K | 880lm | EEK=E
8kWh/1000h



Art. Nr. 1005289



- Verbindungsbox IP68, 3-polig
Art. Nr. 228730
- Erdspieß
Art. Nr. 231230



- Verbindungsbox IP68, 3-polig
Art. Nr. 228730
- Erdspieß
Art. Nr. 231230



- Verbindungsbox IP68, 3-polig
Art. Nr. 228730
- Erdspieß
Art. Nr. 231230



Variante	Art. Nr.
30lm 3000K CRI80 ■ rost	233447

Variante	Art. Nr.
30lm 3000K CRI80 ■ rost	233457

Variante	Art. Nr.
1xE27 ■ rost	229410



RUSTY® SLOT 80
Pole, E27

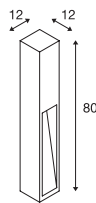

IP 44

220-240V ~50/60Hz
Material: FeCSi-Stahl / Polycarbonat (PC)

- Offenes Kabelende



E27 <11W
Ø: 4,8 cm L: 13,9 cm



LED E27 | 8W | 240°
3000K | 880lm | EEK=E
8kWh/1000h



Art. Nr. 1005289



■ Verbindungsbox IP68, 3-polig

Art. Nr. 228730



■ Erdspieß

Art. Nr. 231230



Variante	Art. Nr.
1xE27	
■ rost	229411

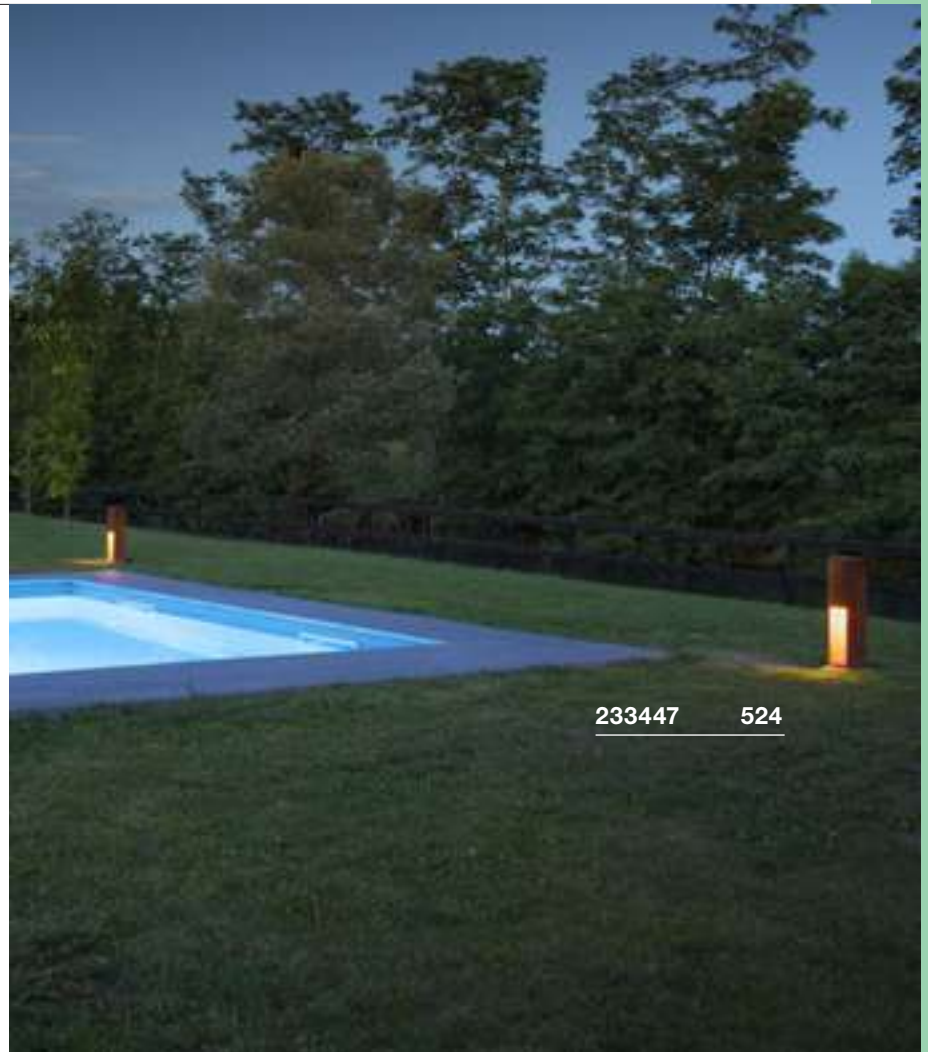

233447

524



229411

525

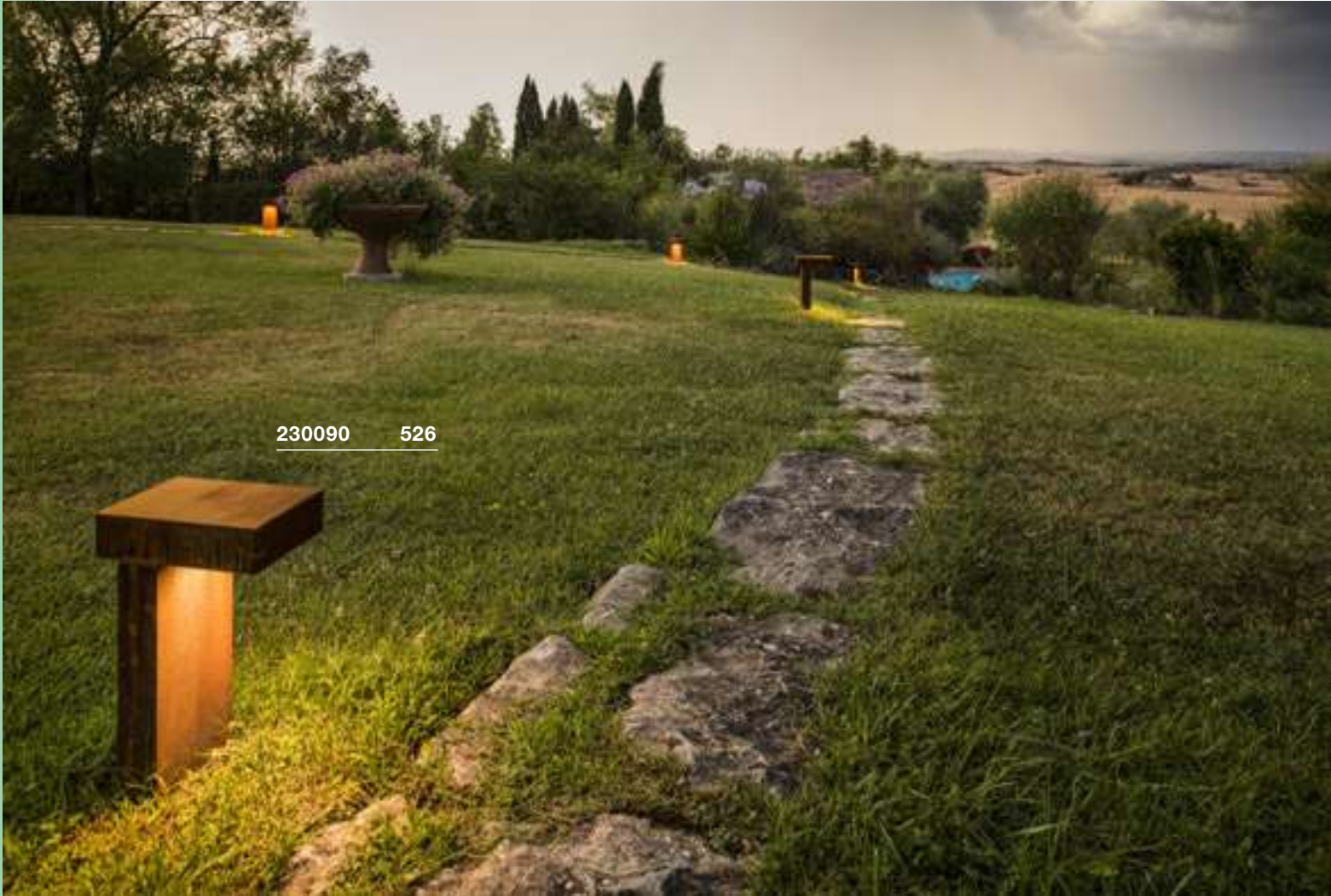

230090 526



1001823 527



RUSTY® PATHLIGHT 40 Pole



RUSTY® PATHLIGHT 70 Pole



RUSTY® PATHLIGHT Pole, TCR-TSE

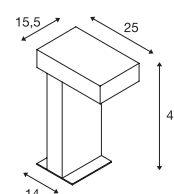
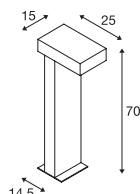
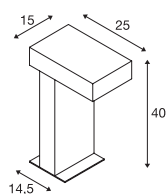
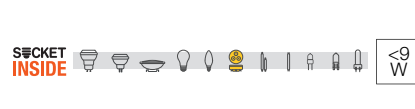

220-240V ~50/60Hz
Systemleistung: 8,9W
Material: FeCSi-Stahl / Polycarbonat (PC)

220-240V ~50/60Hz
Systemleistung: 8,9W
Material: FeCSi-Stahl / Polycarbonat (PC)

220-240V ~50/60Hz
Material: FeCSi-Stahl / Polycarbonat (PC)

- Offenes Kabelende

- Offenes Kabelende

- Offenes Kabelende

1001823	400lm 3000K	

1001824	400lm 3000K	

GX53 <9W
 Ø: 7,5 cm L: 2,7 cm

LED GX53 | 6W | 120°
 4000K | 550lm | EEK=F
 6kWh/1000h

Art. Nr. 1005269

Variante	Art. Nr.
400lm 3000K CRI80	
■ rost	1001823

Variante	Art. Nr.
400lm 3000K CRI80	
■ rost	1001824

Variante	Art. Nr.
1xGX53	
■ rost	230090

RUSTY® 40 Pole



RUSTY® 70 Pole

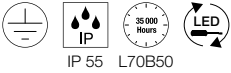
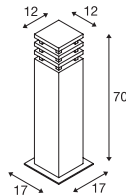
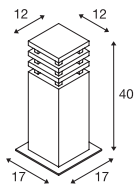
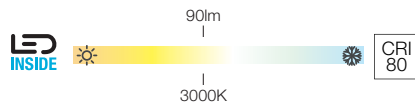
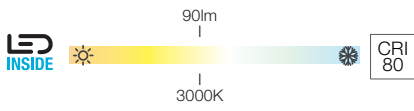

IP 55 L70B50

220-240V ~50/60Hz
Systemleistung: 9W
Material: FeCSI-Stahl / Polycarbonat (PC)

- Offenes Kabelende

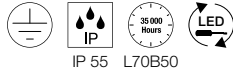

IP 55 L70B50

220-240V ~50/60Hz
Systemleistung: 9W
Material: FeCSI-Stahl / Polycarbonat (PC)

- Offenes Kabelende



233427	90lm 3000K	



233437	90lm 3000K	



- Verbindungsbox IP68, 3-polig
Art. Nr. 228730
- Erdspieß
Art. Nr. 229422



- Verbindungsbox IP68, 3-polig
Art. Nr. 228730
- Erdspieß
Art. Nr. 229422

Variante	Art. Nr.
90lm 3000K CRI80 ■ rost	233427

Variante	Art. Nr.
90lm 3000K CRI80 ■ rost	233437



233427 528

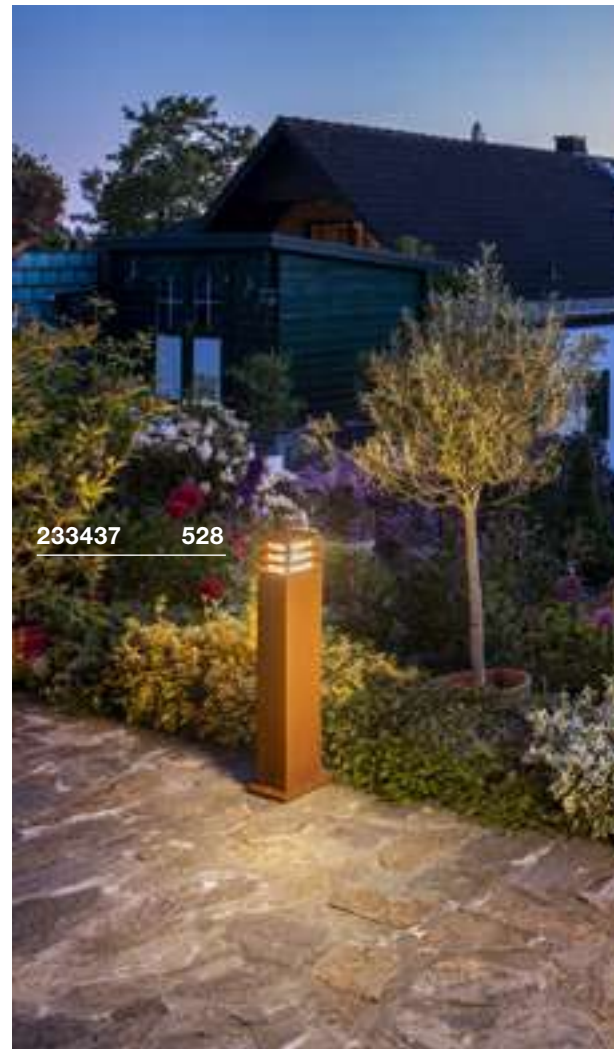

233437 528



RUSTY® 40
Pole, E27



RUSTY® 70
Pole, E27

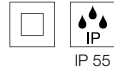
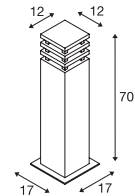
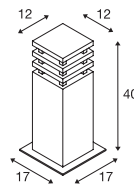

220-240V ~50/60Hz
Material: FeCSi-Stahl / Polycarbonat (PC)

220-240V ~50/60Hz
Material: FeCSi-Stahl / Polycarbonat (PC)

- Offenes Kabelende

- Offenes Kabelende



E27 <11W
Ø: 4,8 cm L: 13,9 cm

E27 <11W
Ø: 4,8 cm L: 13,9 cm



LED E27 | 8W | 240°
3000K | 880lm | EEK=E
8kWh/1000h

LED E27 | 8W | 240°
4000K | 880lm | EEK=E
8kWh/1000h

Art. Nr. 1005289

Art. Nr. 1005290



■ Verbindungsbox IP68, 3-polig
Art. Nr. 228730

■ Verbindungsbox IP68, 3-polig
Art. Nr. 228730

■ Erdspeiß
Art. Nr. 229422

■ Erdspeiß
Art. Nr. 229422

Variante	Art. Nr.
1xE27	
■ rost	229420

Variante	Art. Nr.
1xE27	
■ rost	229421

RUSTY® CONE 24
FL, E14

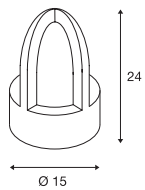

220-240V ~50/60Hz
Material: FeCSi-Stahl / Polycarbonat (PC)

RUSTY® CONE 40
Pole, E27

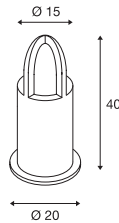

220-240V ~50/60Hz
Material: FeCSi-Stahl / Polycarbonat (PC)

RUSTY® CONE 70
Pole, E27

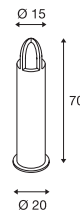

220-240V ~50/60Hz
Material: FeCSi-Stahl / Polycarbonat (PC)



E14 <40W
Ø: 4,8 cm L: 13,9 cm



LED E14 | 4.2W | 320°
2700K | 350lm | EEK=G
5kWh/1000h



Art. Nr. 1005285



E27 <11W
Ø: 4,8 cm L: 13,9 cm



LED E27 | 8W | 240°
3000K | 880lm | EEK=E
8kWh/1000h



Art. Nr. 1005289



■ Verbindungsbox IP68, 3-polig
Art. Nr. 228730



■ Erdspieß
Art. Nr. 229423



E27 <11W
Ø: 4,8 cm L: 13,9 cm



LED E27 | 8W | 240°
4000K | 880lm | EEK=E
8kWh/1000h



Art. Nr. 1005290



■ Verbindungsbox IP68, 3-polig
Art. Nr. 228730



■ Erdspieß
Art. Nr. 229423



Variante	Art. Nr.
1xE14	
■ rost	229430

Variante	Art. Nr.
1xE27	
■ rost	229431

Variante	Art. Nr.
1xE27	
■ rost	229432

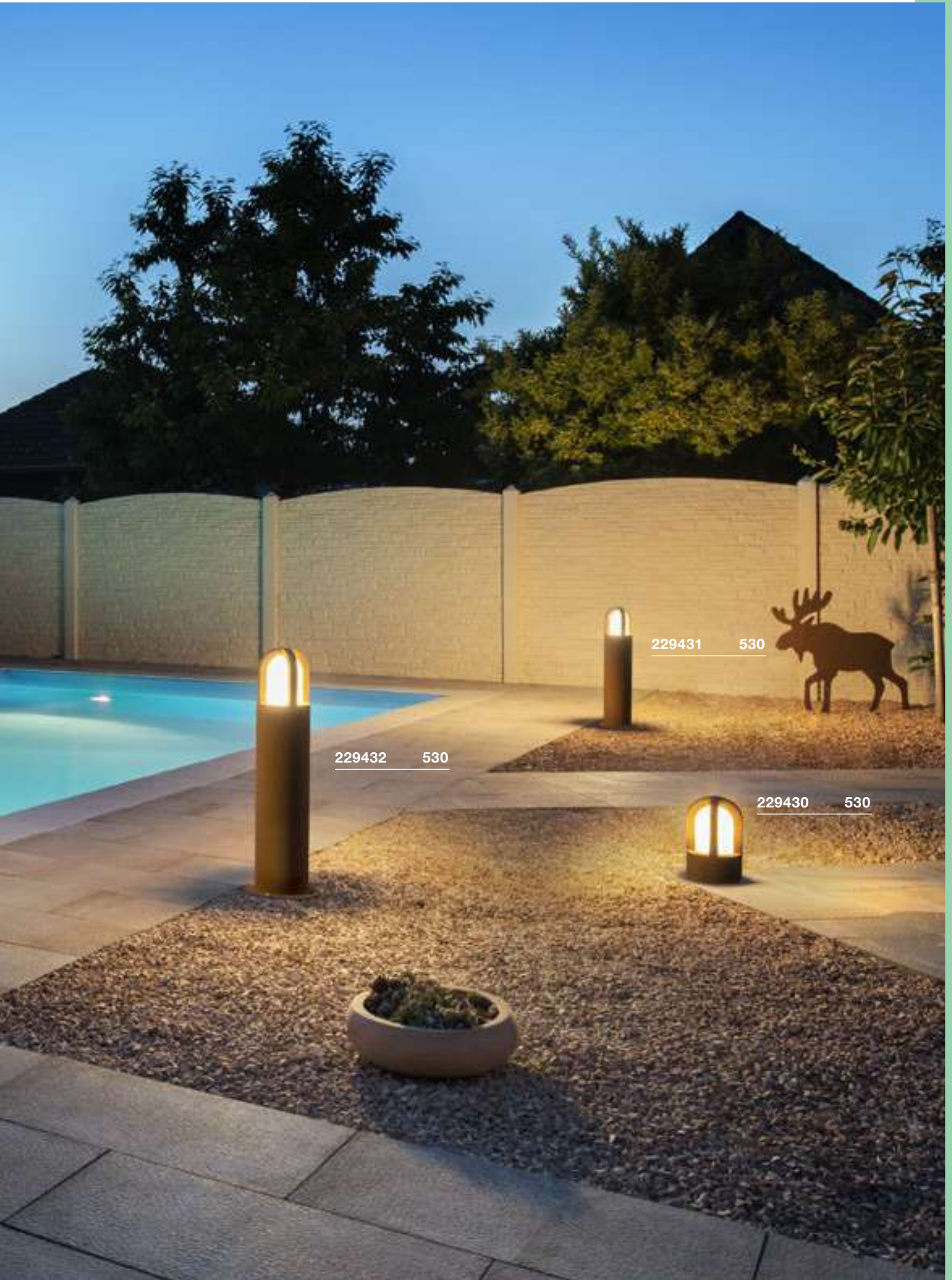

229432 530

229431 530

229430 530

RUSTY® 40 Pole



RUSTY® 70 Pole

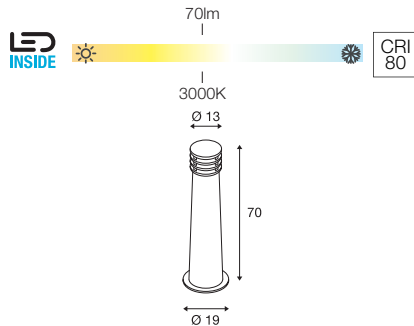
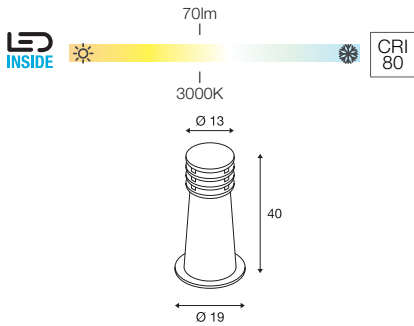

IP 55 L70B50

IP 55 L70B50

220-240V ~50/60Hz
Systemleistung: 9W
Material: FeCSI-Stahl / Polycarbonat (PC)

220-240V ~50/60Hz
Systemleistung: 9W
Material: FeCSI-Stahl / Polycarbonat (PC)

- Offenes Kabelende
- Jede Leuchte ist ein Unikat

- Offenes Kabelende
- Jede Leuchte ist ein Unikat

		A → G
233407	70lm 3000K	A ↑ G ↓ E

		A → G
233417	70lm 3000K	A ↑ G ↓ E

Verbindungsbox IP68, 3-polig
Art. Nr. 228730

Erdspieß
Art. Nr. 229022

Verbindungsbox IP68, 3-polig
Art. Nr. 228730

Erdspieß
Art. Nr. 229022

Variante	Art. Nr.
70lm 3000K CRI80 ■ rost	233407

Variante	Art. Nr.
70lm 3000K CRI80 ■ rost	233417





229021 533



229020 533

RUSTY® 40
Pole, E27



RUSTY® 70
Pole, E27

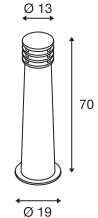
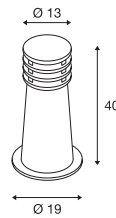

220-240V ~50/60Hz
Material: FeCSi-Stahl / Polycarbonat (PC)

220-240V ~50/60Hz
Material: FeCSi-Stahl / Polycarbonat (PC)

- Offenes Kabelende
- Jede Leuchte ist ein Unikat

- Offenes Kabelende
- Jede Leuchte ist ein Unikat



E27 <11W
Ø: 4,8 cm L: 13,9 cm



E27 <11W
Ø: 4,8 cm L: 13,9 cm



LED E27 | 8W | 240°
3000K | 880lm | EEK=E
8kWh/1000h



Art. Nr. 1005289



LED E27 | 8W | 240°
4000K | 880lm | EEK=E
8kWh/1000h



Art. Nr. 1005290



■ Verbindungsbox IP68, 3-polig
Art. Nr. 228730



■ Erdspieß

Art. Nr. 229022



■ Verbindungsbox IP68, 3-polig
Art. Nr. 228730



■ Erdspieß

Art. Nr. 229022



Variante	Art. Nr.
1xE27	
■ rost	229020

Variante	Art. Nr.
1xE27	
■ rost	229021

ARROCK GRANITE 40
Pole, square, E27

ARROCK GRANITE 70
Pole, square, E27

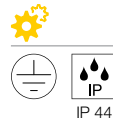
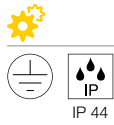
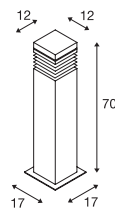
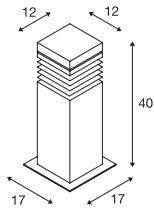
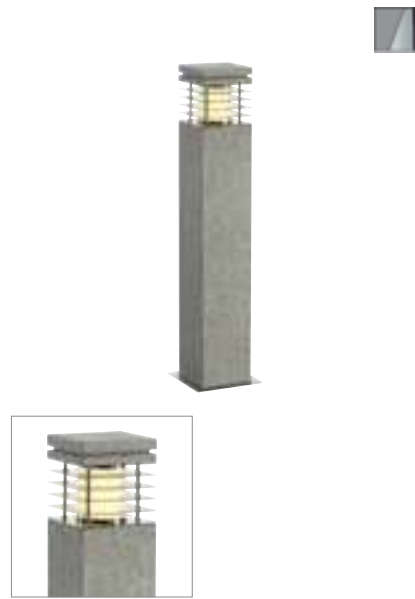

220-240V ~50/60Hz
Material: Granit / Edelstahl 304

220-240V ~50/60Hz
Material: Granit / Edelstahl 304

E27 <15W
Ø: 5,2 cm L: 11,5 cm

E27 <15W
Ø: 5,2 cm L: 11,5 cm

LED E27 | 8W | 240°
3000K | 880lm | EEK=E
8kWh/1000h

LED E27 | 8W | 240°
4000K | 880lm | EEK=E
8kWh/1000h

Verbindungsbox IP68, 3-polig
Art. Nr. 228730

Erdspieß
Art. Nr. 229422

Verbindungsbox IP68, 3-polig
Art. Nr. 228730

Erdspieß
Art. Nr. 229422

Variante	Art. Nr.
1xE27	
grau	231410

Variante	Art. Nr.
1xE27	
grau	231411





231410 534



231420 535

ARROCK ARC
Pole, QPAR51

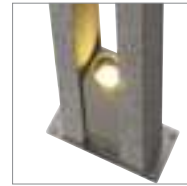

SOCKET INSIDE <35 W

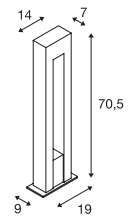

220-240V ~50/60Hz
Material: Granit / Edelstahl 304



GU10 <35W
Ø: 5 cm L: 7,6 cm



LED GU10 51mm | 4W | 36°
2700K | 270lm | EEK=G
4kWh/1000h



Art. Nr. 1004972



■ Erdspeiß
Art. Nr. 231233



Variante	Art. Nr.
1xGU10	
■ grau	231420

ARROCK STONE 50
Pole

ARROCK STONE 75
Pole

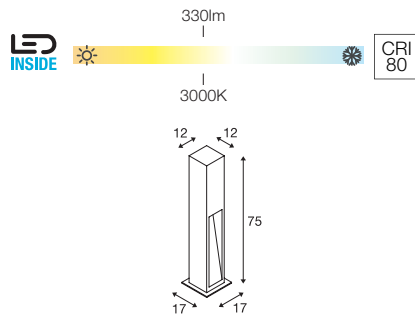
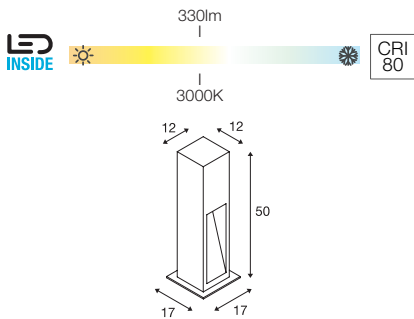

IP 55 L70B50

IP 55 L70B50

100-240V ~50/60Hz | 700mA
Systemleistung: 9W
Material: Basalt / Edelstahl 304

100-240V ~50/60Hz | 700mA
Systemleistung: 9W
Material: Basalt / Edelstahl 304

231370	330lm 3000K	

231371	330lm 3000K	

Erdspieß
 Art. Nr. 231235

Erdspieß
 Art. Nr. 231235

Variante	Art. Nr.
330lm 3000K CRI80	
■ grau	231370

Variante	Art. Nr.
330lm 3000K CRI80	
■ grau	231371





231371 536



231440 537

ARROCK SLOT



SOCKET INSIDE            <4 W

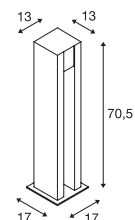

IP 44

220-240V ~50/60Hz
Material: Granit / Edelstahl 304

- Offenes Kabelende



GU10 <4W



LED GU10 51mm | 4W | 36°
3000K | 270lm | EEK=G
4kWh/1000h



Art. Nr. 1004973



■ Verbindungsbox IP68, 3-polig

Art. Nr. 228730



■ Erdspeiß

Art. Nr. 231235



Variante	Art. Nr.
1xGU10	
■ grau	231440

L-LINE OUT 30
FL, vertikal



L-LINE OUT 50
Pole, horizontal



L-LINE OUT 60
FL, vertikal

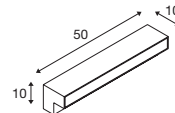
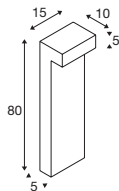
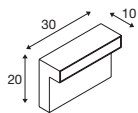
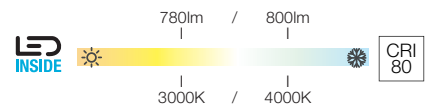
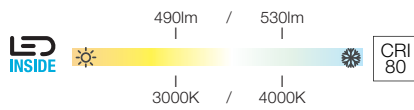
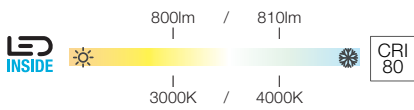
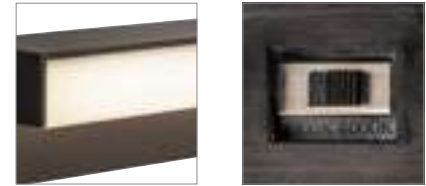

220-240V ~50/60Hz | 500mA
Systemleistung: 11,5W
Material: Aluminium / Polycarbonat (PC)

220-240V ~50/60Hz | 350mA
Systemleistung: 7W
Material: Aluminium / Polycarbonat (PC)

220-240V ~50/60Hz | 500mA
Systemleistung: 11,5W
Material: Aluminium / Polycarbonat (PC)

- Offenes Kabelende
- Die Lichtfarbe muss vor der Installation eingestellt werden

- Offenes Kabelende
- Die Lichtfarbe muss vor der Installation eingestellt werden

- Offenes Kabelende
- Die Lichtfarbe muss vor der Installation eingestellt werden

1003536	800/810lm 3000/4000K	

1003537	490/530lm 3000/4000K	

1003535	780/800lm 3000/4000K	

Verbindungsbox IP68, 3-polig
 Art. Nr. 228730

Verbindungsbox IP68, 3-polig
 Art. Nr. 228730

Verbindungsbox IP68, 3-polig
 Art. Nr. 228730

Variante	Art. Nr.
800/810lm 3000/4000K CRI80	
anthrazit	1003536

Variante	Art. Nr.
490/530lm 3000/4000K CRI80	
anthrazit	1003537

Variante	Art. Nr.
780/800lm 3000/4000K CRI80	
anthrazit	1003535



L-LINE OUT 80
Pole, horizontal

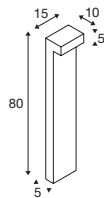
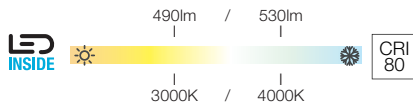

220-240V ~50/60Hz | 350mA
Systemleistung: 7W
Material: Aluminium / Polycarbonat (PC)

- Offenes Kabelende
- Die Lichtfarbe muss vor der Installation eingestellt werden



		A → G
1003538	490/530lm 3000/4000K	A ↑ G ↓



■ Verbindungsbox IP68, 3-polig
Art. Nr. 228730

Variante	Art. Nr.
490/530lm 3000/4000K CRI80	
■ anthrazit	1003538



1003536 538



1003537 538

THEO PATHLIGHT
Pole, single

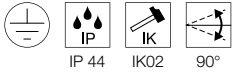
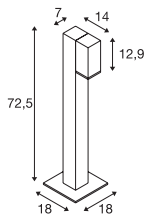

220-240V ~50/60Hz
Material: Aluminium



GU10 <7W



LED GU10 51mm | 4W | 36°
2700K | 270lm | EEK=G
4kWh/1000h



Art. Nr. 1004972



Verbindungsbox IP68, 3-polig
Art. Nr. 228730



Variante	Art. Nr.
1xGU10	
■ anthrazit	1002870

THEO PATHLIGHT
Pole, double

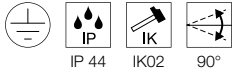
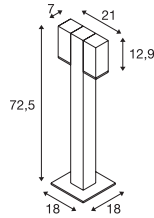

220-240V ~50/60Hz
Material: Aluminium



GU10 <7W



LED GU10 51mm | 4W | 36°
3000K | 270lm | EEK=G
4kWh/1000h



Art. Nr. 1004973



Verbindungsbox IP68, 3-polig
Art. Nr. 228730



Variante	Art. Nr.
2xGU10	
■ anthrazit	1002871



1002871

540





1004655 541

THEO BRACKET 50 Pole



THEO BRACKET 70 Pole

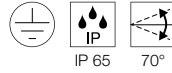
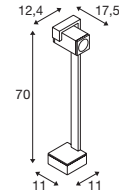
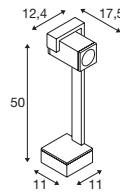

220-240V ~50/60Hz
Material: Aluminium / Glas

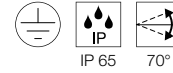

220-240V ~50/60Hz
Material: Aluminium / Glas



GU10 <7W
Ø: 5,1 cm L: 5,7 cm



GU10 <7W
Ø: 5,1 cm L: 5,7 cm



LED GU10 51mm | 4W | 36°
2700K | 270lm | EEK=G
4kWh/1000h

Art. Nr. 1004972



LED GU10 51mm | 4W | 36°
3000K | 270lm | EEK=G
4kWh/1000h

Art. Nr. 1004973

Variante	Art. Nr.
1xGU10	
■ anthrazit	1004654

Variante	Art. Nr.
1xGU10	
■ anthrazit	1004655

OVALISK 75
Pole



OVALISK 100
Pole

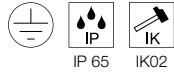
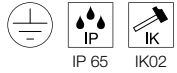
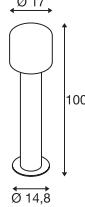
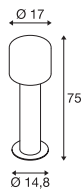
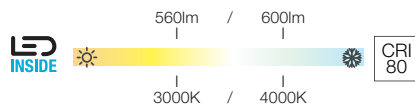
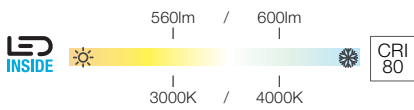

100-240V ~50/60Hz | 500mA
Systemleistung: 9W
Material: Aluminium / Glas

100-240V ~50/60Hz | 500mA
Systemleistung: 9W
Material: Aluminium / Glas



1004680	580/630lm 3000/4000K	

1004681	580/630lm 3000/4000K	



- Betonanker
Art. Nr. 228712
- Erdspieß
Art. Nr. 228722
- Verbindungsbox IP68, 3-polig
Art. Nr. 228730

- Betonanker
Art. Nr. 228712
- Erdspieß
Art. Nr. 228722
- Verbindungsbox IP68, 3-polig
Art. Nr. 228730

Variante	Art. Nr.
560/600lm 3000/4000K CRI80	
■ anthrazit	1004680

Variante	Art. Nr.
560/600lm 3000/4000K CRI80	
■ anthrazit	1004681

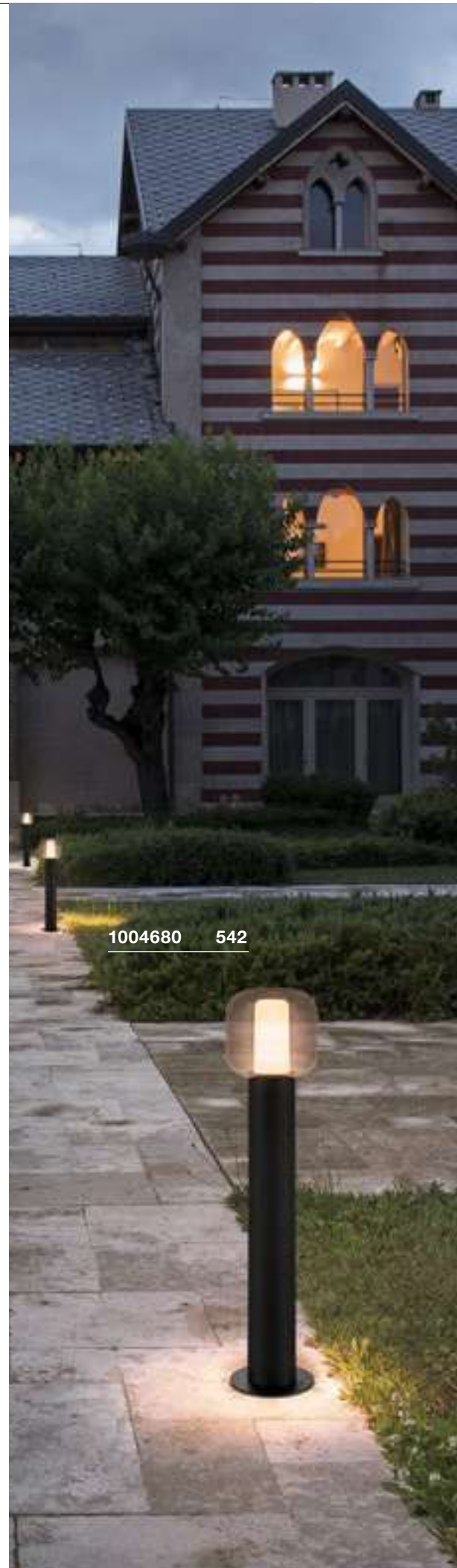

1004680 542



1004681 542





GLOO PURE 27
Pole, E27

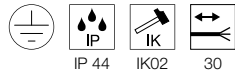
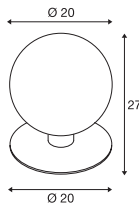

220-240V ~50/60Hz
Material: Aluminium / Glas

- Offenes Kabelende

GLOO PURE 44
Pole, E27

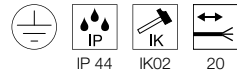
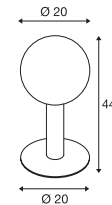

220-240V ~50/60Hz
Material: Aluminium / Glas

- Offenes Kabelende

GLOO PURE 70
Pole, E27

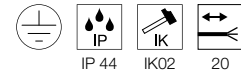
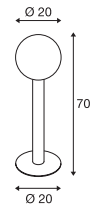

220-240V ~50/60Hz
Material: Aluminium / Glas

- Offenes Kabelende



E27 <23W
Ø: 4,8 cm L: 18 cm



LED E27 | 8W | 240°
3000K | 870lm | EEK=E
8kWh/1000h



Art. Nr. 1005289



■ Verbindungsbox IP68, 3-polig
Art. Nr. 228730



■ Erdspieß
Art. Nr. 231234



Variante	Art. Nr.
1xE27	
■ anthrazit	1001999



E27 <23W
Ø: 4,8 cm L: 18 cm



LED E27 | 8W | 240°
3000K | 870lm | EEK=E
8kWh/1000h



Art. Nr. 1005289



■ Verbindungsbox IP68, 3-polig
Art. Nr. 228730



■ Erdspieß
Art. Nr. 231234



Variante	Art. Nr.
1xE27	
■ anthrazit	1002000



E27 <23W
Ø: 4,8 cm L: 18 cm



LED E27 | 8W | 240°
4000K | 880lm | EEK=E
8kWh/1000h



Art. Nr. 1005290



■ Verbindungsbox IP68, 3-polig
Art. Nr. 228730



■ Erdspieß
Art. Nr. 231234



Variante	Art. Nr.
1xE27	
■ anthrazit	1002001

ROTOBALL 25
FL, E27



ROTOBALL 40
FL, E27



ROTOBALL 50
FL, E27

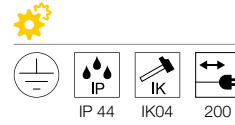
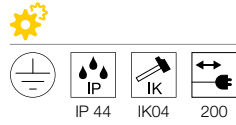
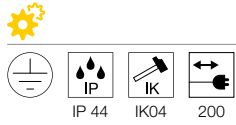
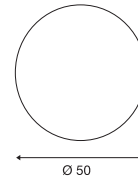
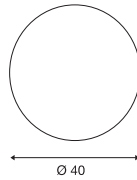
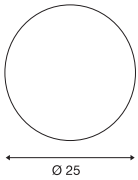

220-240V ~50/60Hz
Material: Stahl / Polyethylen (PE)

220-240V ~50/60Hz
Material: Stahl / Polyethylen (PE)

220-240V ~50/60Hz
Material: Stahl / Polyethylen (PE)

- IP 44 Konturenstecker

- IP44 Schutzkontaktstecker

- IP44 Schutzkontaktstecker

E27 <24W

E27 <24W
Ø: 9,5 cm

E27 <24W
Ø: 9,5 cm

LED E27 | 7,5W | 320°
2700K | 700lm | EEK=F
8kWh/1000h



LED E27 | 9W | 220°
2700K | 770lm | EEK=F
9kWh/1000h



LED E27 | 13,2W | 220°
2700K | 1300lm | EEK=F
13kWh/1000h



Art. Nr. 1005304

Art. Nr. 1005301

Art. Nr. 1005302

Variante	Art. Nr.
1xE27	
<input type="checkbox"/> weiß	227219

Variante	Art. Nr.
1xE27	
<input type="checkbox"/> weiß	227220

Variante	Art. Nr.
1xE27	
<input type="checkbox"/> weiß	227221



227221 546

227219 546

PHOTONIA
PD, E27

PHOTONIA
TL, E27

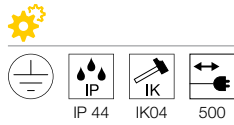
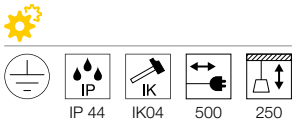
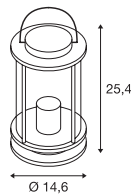
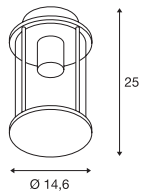

220-240V ~50/60Hz
Material: Aluminium / Glas

220-240V ~50/60Hz
Material: Aluminium / Glas

- IP44 Schutzkontaktstecker
- Kette für Abhängung inkl.

- IP44 Schutzkontaktstecker

E27 <60W
Ø: 9 cm L: 15 cm

E27 <60W
Ø: 9 cm L: 15 cm

LED E27 | 7,5W | 320°
2700K | 800lm | EEK=F
8kWh/1000h



Art. Nr. 1005268

LED E27 | 7,5W | 320°
2700K | 800lm | EEK=F
8kWh/1000h



Art. Nr. 1005268

Deckenrosette
Art. Nr. 1000398



Variante	Art. Nr.
1xE27	
■ anthrazit	232065

Variante	Art. Nr.
1xE27	
■ anthrazit	232095 ▼

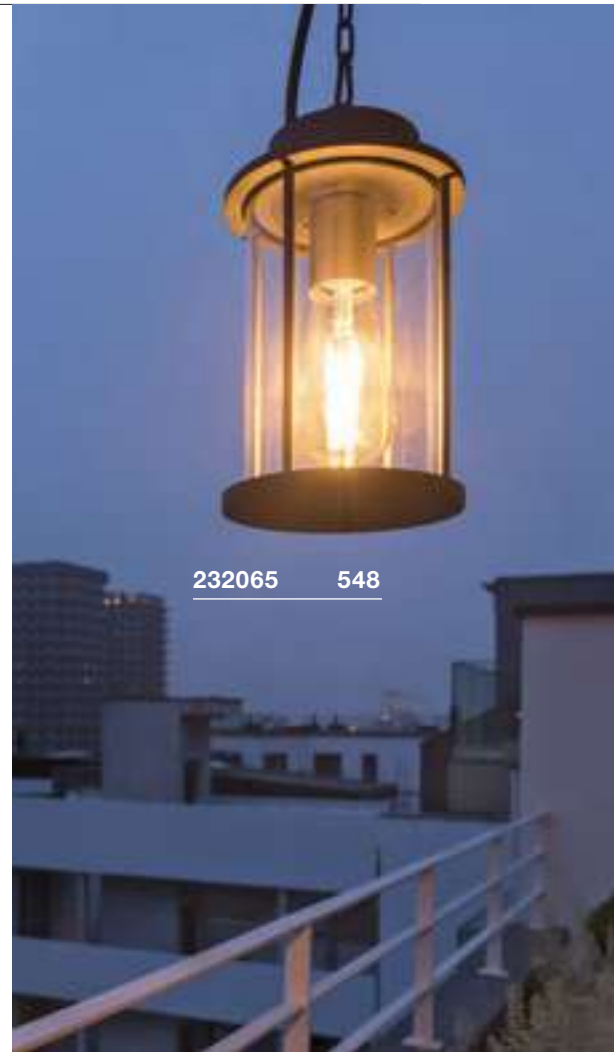

232065 548



232095 548



232075 549



PHOTONIA
Pole, E27



SOCKET INSIDE <60 W

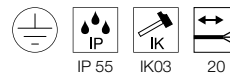

220-240V ~50/60Hz
Material: Aluminium / Glas

- Offenes Kabelende



E27 <60W
Ø: 9 cm L: 15 cm



LED E27 | 7,5W | 320°
2500K | 700lm | EEK=F
8kWh/1000h



Art. Nr. 1005265



■ Verbindungsbox IP68, 3-polig

Art. Nr. 228730

■ Betonanker

Art. Nr. 232085



Variante	Art. Nr.
1xE27	
■ anthrazit	232075

OTOS GLAS
Pole, E27

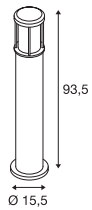

220-240V ~50/60Hz
Material: Aluminium / Glas

- Betonanker inkl.



E27 <15W
Ø: 6,5 cm L: 14,5 cm



LED E27 | 13,2W | 220°
2700K | 1300lm | EEK=F
13kWh/1000h

Art. Nr. 1005302



■ Verbindungsbox IP68, 3-polig

Art. Nr. 228730

■ Schraubenset

Art. Nr. 228753



Variante	Art. Nr.
1xE27	
■ anthrazit	230465

■ anthrazit 230465



230465 550



132835 551



230435 551



CUBIX
FL, QPAR51

CONE
FL, E27

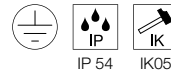
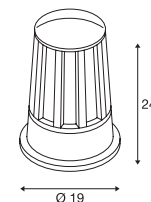
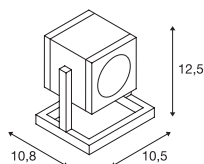

220-240V ~50/60Hz
Material: Aluminium / Glas

220-240V ~50/60Hz
Material: Aluminium / Glas

- IP44 Schutzkontaktstecker



GU10 <25W



E27 <100W
L: 15 cm



LED GU10 51mm | 4W | 36°
2700K | 270lm | EEK=G
4kWh/1000h

Art. Nr. 1004972



LED E27 | 13,2W | 220°
2700K | 1300lm | EEK=F
13kWh/1000h

Art. Nr. 1005302



Variante	Art. Nr.
1xGU10	
■ anthrazit	132835

Variante	Art. Nr.
1xE27	
■ anthrazit	230435

MOLAT
PD, E27



MOLAT
Pole, E27

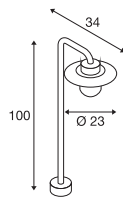
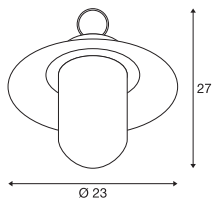

220-240V ~50/60Hz
Material: Aluminium / Glas

- IP44 Schutzkontaktstecker
- Kette für Abhängung inkl.

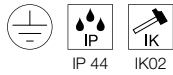

220-240V ~50/60Hz
Material: Aluminium / Glas



E27 60W
Ø: 6,5 cm L: 14,5 cm



E27 60W
Ø: 6,5 cm L: 14,5 cm



LED E27 | 7,5W | 320°
2500K | 700lm | EEK=F
8kWh/1000h



Art. Nr. 1005265



LED E27 | 7,5W | 320°
2500K | 700lm | EEK=F
8kWh/1000h



Art. Nr. 1005265



■ Deckenrosette
Art. Nr. 1000398



■ Erdspieß
Art. Nr. 230060



Variante	Art. Nr.
1xE27	
■ anthrazit	1000821

Variante	Art. Nr.
1xE27	
■ anthrazit	1000822

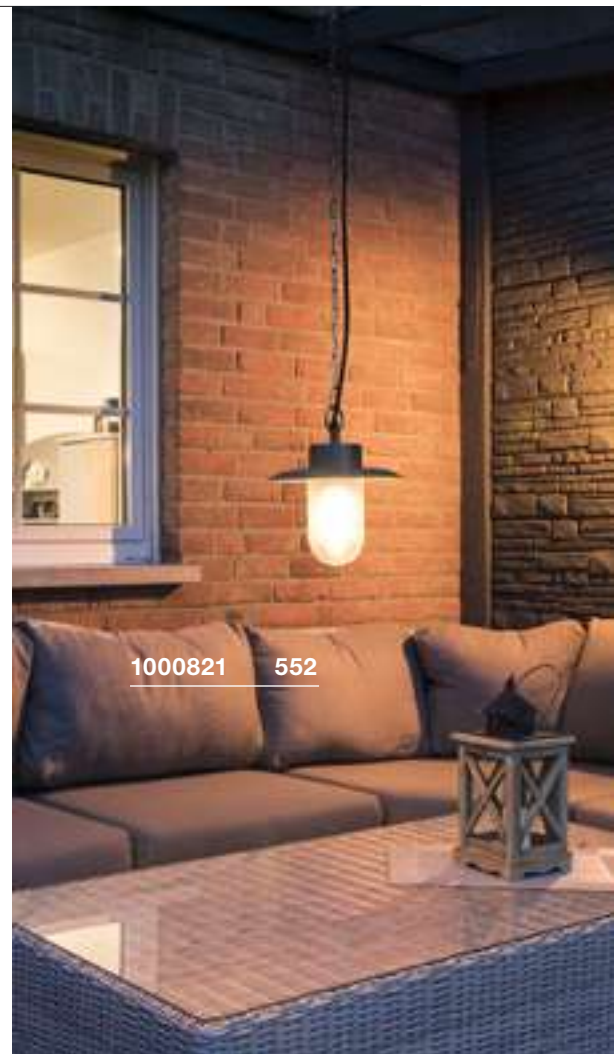

1000821 552



1000822 552

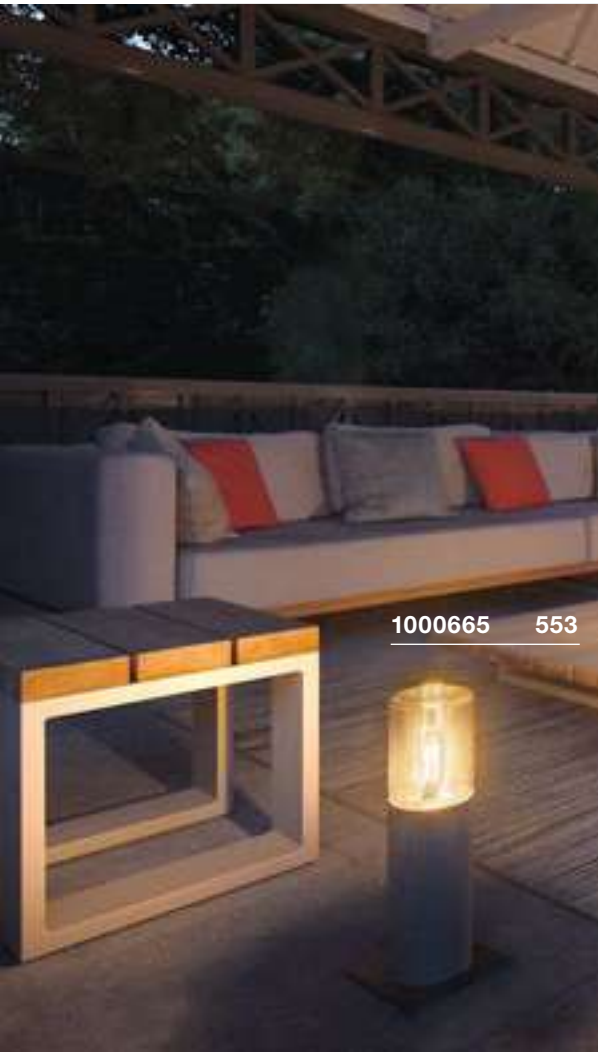

1000665 553



1000666 553

LISENNE 40
Pole, E27



LISENNE 70
Pole, E27

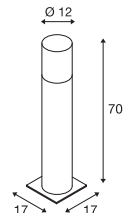
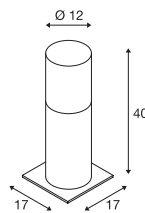

IP 54

220-240V ~50/60Hz
Material: Basalt / Glas



IP 54

220-240V ~50/60Hz
Material: Basalt / Glas



E27 <23W
Ø: 5,9 cm L: 15 cm



E27 <23W
Ø: 5,9 cm L: 15 cm



LED E27 | 7,5W | 320°
2700K | 800lm | EEK=F
8kWh/1000h



Art. Nr. 1005268



LED E27 | 7,5W | 320°
2700K | 800lm | EEK=F
8kWh/1000h



Art. Nr. 1005268



■ Erdspieß
Art. Nr. 229422



■ Erdspieß
Art. Nr. 229422



Variante	Art. Nr.
1xE27	
■ grau / braun	1000665

Variante	Art. Nr.
1xE27	
■ grau / braun	1000666

ADEGAN MANILA
FL, E27

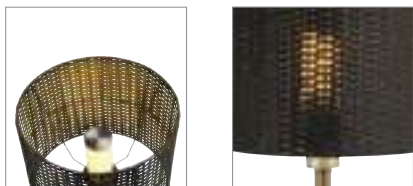

SOCKET INSIDE

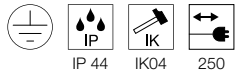
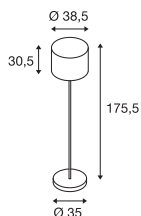

220-240V ~50/60Hz
Material: Granit / Edelstahl

- IP44 Schutzkontaktstecker



E27 <15W
Ø: 4,8 cm L: 18 cm



LED E27 | 8W | 240°
3000K | 880lm | EEK=E
8kWh/1000h



Art. Nr. 1005289

Variante	Art. Nr.
1xE27 schwarz/edelstahl	1002494



1002494 554

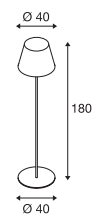

228965 555

ADEGAN
FL, E27SOCKET
INSIDE <15
W

IP 44

IK04

250

220-240V ~50/60Hz
Material: Granit / Edelstahl

- IP44 Schutzkontaktstecker

E27 <15W
Ø: 4,8 cm L: 18 cmLED E27 | 8W | 240°
3000K | 880lm | EEK=E
8kWh/1000h

Art. Nr. 1005289

Variante	Art. Nr.
1xE27	
anthrazit/milchig	228965



228925 557



228935 557



ALPA MUSHROOM 45
Pole, E27

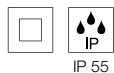
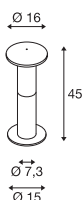

220-240V ~50/60Hz
Material: Aluminium / Polycarbonat (PC)

- Offenes Kabelende

ALPA MUSHROOM 75
Pole, E27

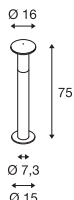

220-240V ~50/60Hz
Material: Aluminium / Polycarbonat (PC)

- Offenes Kabelende

ALPA CONE 100
Pole, E27

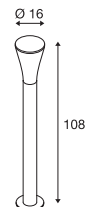

220-240V ~50/60Hz
Material: Aluminium / Polycarbonat (PC)

- Offenes Kabelende



E27 <24W
Ø: 5,2 cm L: 16 cm



LED E27 | 13,5W | 240°
3000K | 1520lm | EEK=E
14kWh/1000h

Art. Nr. 1005307



■ Betonanker
Art. Nr. 228712

■ Erdspieß
Art. Nr. 228722

■ Verbindungsbox IP68, 3-polig
Art. Nr. 228730



E27 <24W
Ø: 5,2 cm L: 16 cm



LED E27 | 13,5W | 240°
4000K | 1520lm | EEK=E
14kWh/1000h

Art. Nr. 1005308



■ Betonanker
Art. Nr. 228712

■ Erdspieß
Art. Nr. 228722

■ Verbindungsbox IP68, 3-polig
Art. Nr. 228730



E27 <24W
Ø: 5,2 cm L: 17,5 cm



LED E27 | 8W | 240°
3000K | 870lm | EEK=E
8kWh/1000h

Art. Nr. 1005289



■ Betonanker
Art. Nr. 228712

■ Erdspieß
Art. Nr. 228722

■ Verbindungsbox IP68, 3-polig
Art. Nr. 228730



Variante	Art. Nr.
1xE27	
■ anthrazit	228935

Variante	Art. Nr.
1xE27	
■ anthrazit	228945

Variante	Art. Nr.
1xE27	
■ anthrazit	228925

APONI 90
Pole, PHASE



APONI 120
Pole, PHASE

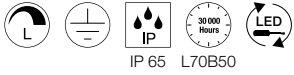
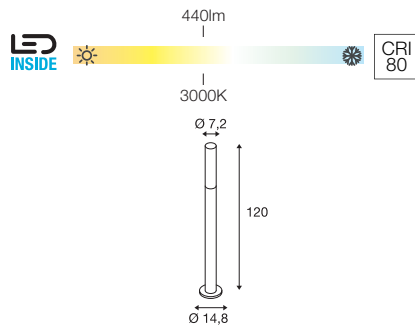
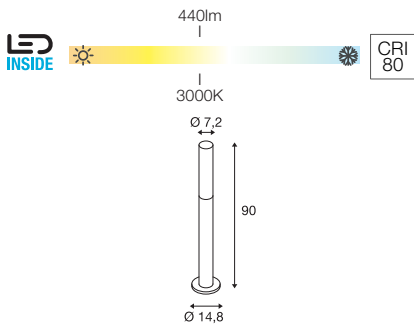

IP 65 L70B50

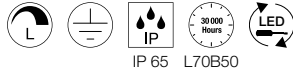

IP 65 L70B50

220-240V ~50/60Hz
Systemleistung: 8W
Material: Aluminium

220-240V ~50/60Hz
Systemleistung: 8W
Material: Aluminium

- Offenes Kabelende

- Offenes Kabelende



1000682	520lm 3000K	

1000683	520lm 3000K	



■ Verbindungsbox IP68, 3-polig
Art. Nr. 228730



■ Verbindungsbox IP68, 3-polig
Art. Nr. 228730



Variante	Art. Nr.
440lm 3000K CRI80 ■ anthrazit	1000682

Variante	Art. Nr.
440lm 3000K CRI80 ■ anthrazit	1000683



1000683 558





TRUST 30
Pole

TRUST 60
Pole

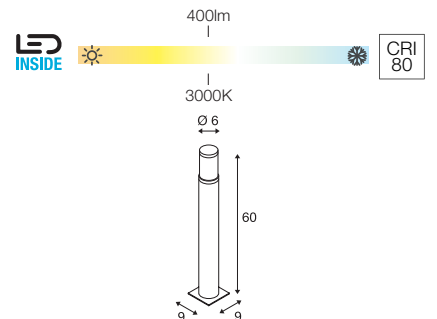
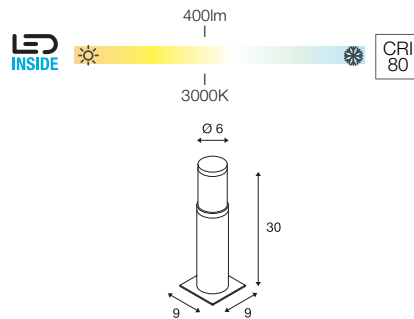

220-240V ~50/60Hz
Systemleistung: 9W
Material: Edelstahl 316

220-240V ~50/60Hz
Systemleistung: 9W
Material: Edelstahl 316

228100	400lm 3000K	

228110	400lm 3000K	

- Erdspeiß**
Art. Nr. 227922
- Raster ringförmig**
Art. Nr. 228130
- Verbindungsbox IP68, 3-polig**
Art. Nr. 228730

- Erdspeiß**
Art. Nr. 227922
- Raster ringförmig**
Art. Nr. 228130
- Verbindungsbox IP68, 3-polig**
Art. Nr. 228730

228110 559

Variante	Art. Nr.
400lm 3000K CRI80 ■ edelstahl	228100

Variante	Art. Nr.
400lm 3000K CRI80 ■ edelstahl	228110

BIG NAILS 50
POLE, E27



BIG NAILS 80
POLE, E27

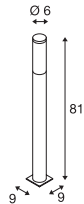
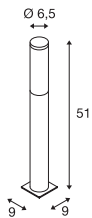

220-240V ~50/60Hz
Material: Edelstahl 304 / Polycarbonat (PC)

220-240V ~50/60Hz
Material: Edelstahl 304 / Polycarbonat (PC)



E27 <15W
Ø: 4,5 cm L: 17 cm



E27 <15W
Ø: 4,5 cm L: 17 cm



LED E27 | 8W | 240°
3000K | 880lm | EEK=E
8kWh/1000h



Art. Nr. 1005289



LED E27 | 8W | 240°
3000K | 880lm | EEK=E
8kWh/1000h



Art. Nr. 1005289



■ Erdspieß
Art. Nr. 227922



■ Erdspieß
Art. Nr. 227922



Variante	Art. Nr.
1xE27	
■ edelstahl	229162

Variante	Art. Nr.
1xE27	
■ edelstahl	229172



229172 560



1001490 561



ROX ACRYL 30

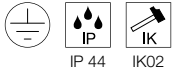
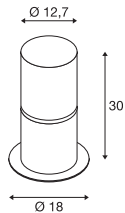

220-240V ~50/60Hz
Material: Edelstahl 304

ROX ACRYL 60

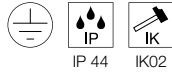
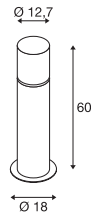

220-240V ~50/60Hz
Material: Edelstahl 304

ROX ACRYL 90

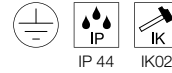
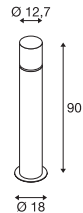

220-240V ~50/60Hz
Material: Edelstahl 304



E27 <20W
Ø: 6 cm L: 15 cm



LED E27 | 9W | 220°
2700K | 800lm | EEK=F
9kWh/1000h



Art. Nr. 1005301



■ T-Verbindebox
Art. Nr. 228726



■ Erdspieß
Art. Nr. 231234



■ Betonanker
Art. Nr. 1001494



E27 <20W
Ø: 6 cm L: 15 cm



LED E27 | 13,2W | 220°
2700K | 1300lm | EEK=F
13kWh/1000h



Art. Nr. 1005302



■ T-Verbindebox
Art. Nr. 228726



■ Erdspieß
Art. Nr. 231234



■ Betonanker
Art. Nr. 1001494



E27 <20W
Ø: 6 cm L: 15 cm



LED E27 | 7,5W | 320°
2700K | 700lm | EEK=F
8kWh/1000h



Art. Nr. 1005304



■ T-Verbindebox
Art. Nr. 228726



■ Erdspieß
Art. Nr. 231234



■ Betonanker
Art. Nr. 1001494



Variante	Art. Nr.
1xE27	
■ edelstahl	1001488

Variante	Art. Nr.
1xE27	
■ edelstahl	1001489

Variante	Art. Nr.
1xE27	
■ edelstahl	1001490

VAP 40

VAP 70

VAP 100

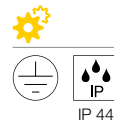
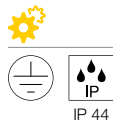
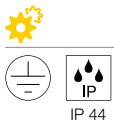
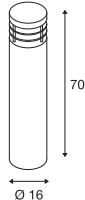
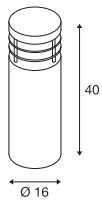

220-240V ~50/60Hz
Material: Edelstahl 304

220-240V ~50/60Hz
Material: Edelstahl 304

220-240V ~50/60Hz
Material: Edelstahl 304

E27 <23W
Ø: 5,2 cm L: 12,1 cm

E27 <23W
Ø: 5,2 cm L: 12,1 cm

E27 <23W
Ø: 5,2 cm L: 12,1 cm

LED E27 | 8W | 240°
3000K | 880lm | EEK=E
8kWh/1000h

LED E27 | 8W | 240°
3000K | 880lm | EEK=E
8kWh/1000h

LED E27 | 8W | 240°
4000K | 880lm | EEK=E
8kWh/1000h

Art. Nr. 1005289

Art. Nr. 1005289

Art. Nr. 1005290

Verbindungsbox IP68, 3-polig
Art. Nr. 228730

Verbindungsbox IP68, 3-polig
Art. Nr. 228730

Verbindungsbox IP68, 3-polig
Art. Nr. 228730

Betonanker
Art. Nr. 229059

Betonanker
Art. Nr. 229059

Betonanker
Art. Nr. 229059

Variante	Art. Nr.
1xE27	
edelstahl	229054

Variante	Art. Nr.
1xE27	
edelstahl	229057

Variante	Art. Nr.
1xE27	
edelstahl	229050



229054 562



229050 562

229057 562



230066 565



VAP SLIM 30
Pole, E27

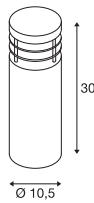

220-240V ~50/60Hz
Material: Edelstahl 304

VAP SLIM 60
Pole, E27

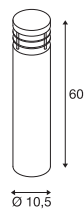

220-240V ~50/60Hz
Material: Edelstahl 304

VAP SLIM 90
Pole, E27

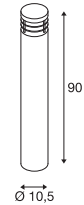

220-240V ~50/60Hz
Material: Edelstahl 304



E27 <20W
Ø: 5 cm L: 12,6 cm



LED E27 | 8W | 240°
3000K | 880lm | EEK=E
8kWh/1000h



Art. Nr. 1005289



■ Erdspieß
Art. Nr. 230060
■ Betonanker
Art. Nr. 230061



E27 <20W
Ø: 5 cm L: 12,6 cm



LED E27 | 8W | 240°
4000K | 880lm | EEK=E
8kWh/1000h



Art. Nr. 1005290



■ Erdspieß
Art. Nr. 230060
■ Betonanker
Art. Nr. 230061



E27 <20W
Ø: 5 cm L: 12,6 cm



LED E27 | 8W | 240°
3000K | 880lm | EEK=E
8kWh/1000h



Art. Nr. 1005289



■ Erdspieß
Art. Nr. 230060
■ Betonanker
Art. Nr. 230061



Variante	Art. Nr.
1xE27	
■ edelstahl	230063

Variante	Art. Nr.
1xE27	
■ edelstahl	230066

Variante	Art. Nr.
1xE27	
■ edelstahl	230069

C-POL
POLE, E27

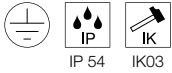
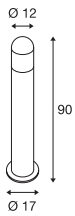

220-240V ~50/60Hz
Material: Aluminium / Polycarbonat (PC)



E27 <24W
Ø: 5,2 cm L: 17,3 cm



LED E27 | 8W | 240°
3000K | 870lm | EEC=E
8kWh/1000h



Art. Nr. 1005289



■ Verbindungsbox IP68, 3-polig
Art. Nr. 228730



Variante	Art. Nr.
1xE27	
■ anthrazit	231475



231475 566





231595 567

F-POL
POLE, E27



SOCKET INSIDE <20 W

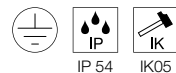
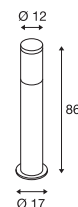

220-240V ~50/60Hz
Material: Aluminium / Polycarbonat (PC)



E27 <20W
Ø: 5 cm L: 14,8 cm



LED E27 | 8W | 240°
3000K | 870lm | EEK=E
8kWh/1000h



Art. Nr. 1005289



■ Verbindungsbox IP68, 3-polig
Art. Nr. 228730



Variante	Art. Nr.
1xE27	
■ anthrazit	231595

SQUARE POLE 30
Pole, E27

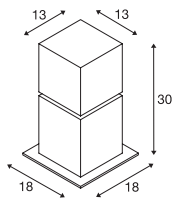

220-240V ~50/60Hz
Material: Edelstahl 304

SQUARE POLE 60
Pole, E27

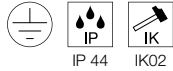
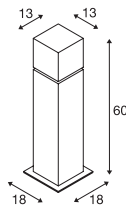

220-240V ~50/60Hz
Material: Edelstahl 304

SQUARE POLE 90
Pole, E27

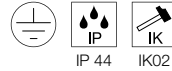
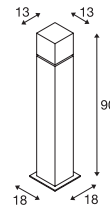

220-240V ~50/60Hz
Material: Edelstahl 304



E27 <20W
Ø: 6 cm L: 15 cm



LED E27 | 9W | 220°
2700K | 800lm | EEK=F
9kWh/1000h



Art. Nr. 1005301



■ Verbindungsbox IP68, 3-polig
Art. Nr. 228730



■ Erdspieß
Art. Nr. 231234



■ Betonanker
Art. Nr. 1000343



E27 <20W
Ø: 6 cm L: 15 cm



LED E27 | 9W | 220°
2700K | 800lm | EEK=F
9kWh/1000h



Art. Nr. 1005301



■ Verbindungsbox IP68, 3-polig
Art. Nr. 228730



■ Erdspieß
Art. Nr. 231234



■ Betonanker
Art. Nr. 1000343



E27 <20W
Ø: 6 cm L: 15 cm



LED E27 | 9W | 220°
2700K | 800lm | EEK=F
9kWh/1000h



Art. Nr. 1005301



■ Verbindungsbox IP68, 3-polig
Art. Nr. 228730



■ Erdspieß
Art. Nr. 231234



■ Betonanker
Art. Nr. 1000343



Variante	Art. Nr.
1xE27	
■ edelstahl	1000344

Variante	Art. Nr.
1xE27	
■ edelstahl	1000345

Variante	Art. Nr.
1xE27	
■ edelstahl	1000346



1000344 569



1000346 569

SLOTS 45
Pole

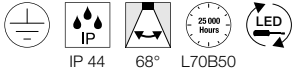
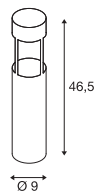
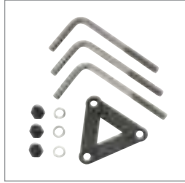

220-240V ~50/60Hz
Systemleistung: 6,3W
Material: Aluminium

- Betonanker inkl.

231817 570



		A → G
231815, 231817	200lm 3000K	A → E



- Verbindungsbox IP68, 3-polig
Art. Nr. 228730
- Schraubenset
Art. Nr. 228753



Variante	Art. Nr.
200lm 3000K CRI80	
■ anthrazit	231815
200lm 3000K CRI80	
■ rost	231817

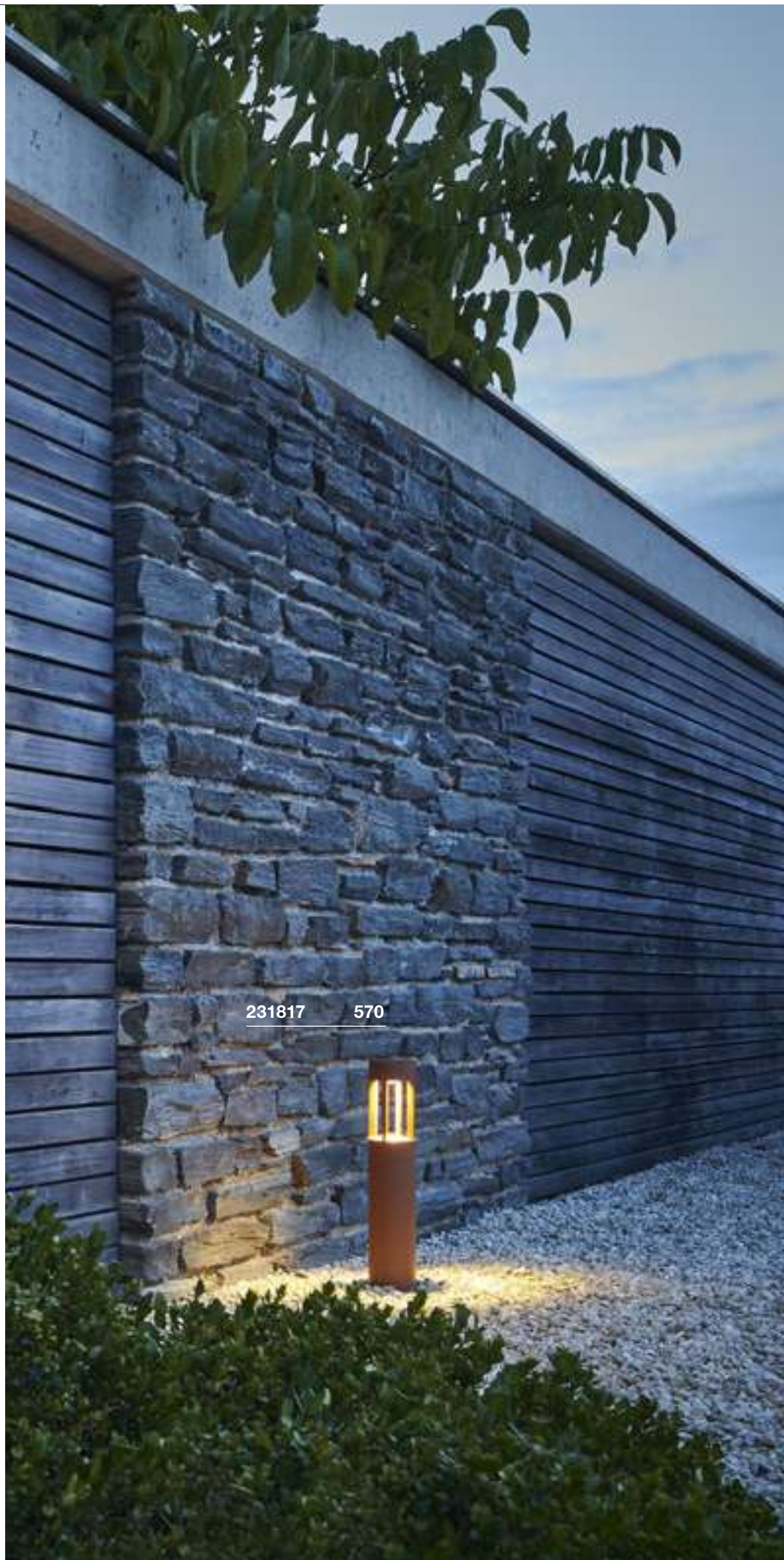



231455 571

SLOTS 65 Pole

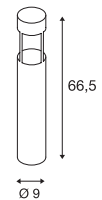
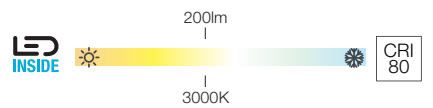
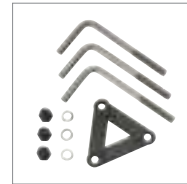

220-240V ~50/60Hz
 Systemleistung: 6,3W
 Material: Aluminium

- Betonanker inkl.



231455, 231457	200lm 3000K	



■ Verbindungsbox IP68, 3-polig
 Art. Nr. 228730



■ Schraubenset
 Art. Nr. 228753



Variante	Art. Nr.
200lm 3000K CRI80	
■ anthrazit	231455
200lm 3000K CRI80	
■ rost	231457

H-POL 30 Pole

H-POL 60 Pole

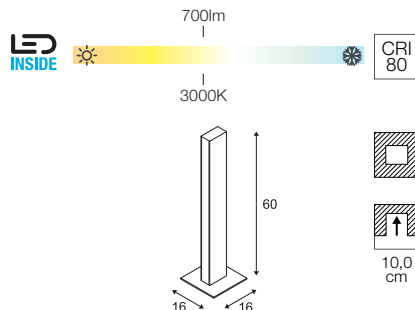
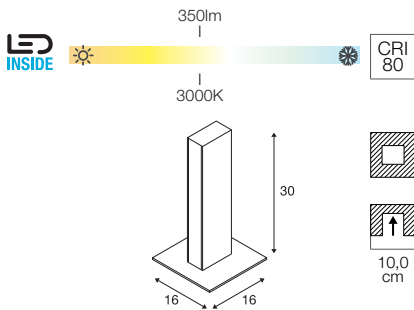
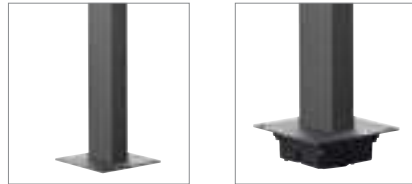
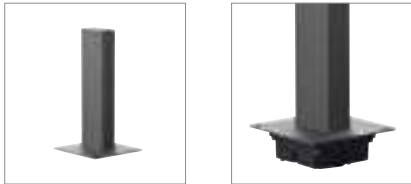

IP 55 L70B50 36

IP 55 L70B50 18

100-277V ~50/60Hz | 500mA
Systemleistung: 9W
Material: Aluminium / Kunststoff

100-277V ~50/60Hz | 500mA
Systemleistung: 18W
Material: Aluminium / Kunststoff

- Das Produkt ist zum Bodeneinbau vorgesehen.
- Einbautopf inkl.
- Zur optionalen Montage im Erdreich steht ein größerer Einbautopf zur Verfügung. Einbaumaße des optionalen Einbautopfes: L: 14 cm B: 14 cm T: 16 cm

- Das Produkt ist zum Bodeneinbau vorgesehen.
- Einbautopf inkl.
- Zur optionalen Montage im Erdreich steht ein größerer Einbautopf zur Verfügung. Einbaumaße des optionalen Einbautopfes: L: 14 cm B: 14 cm T: 16 cm

		A → G
Direkt	350lm 3000K	A T G E

		A → G
Direkt	700lm 3000K	A T G E

■ Einbautopf, 14x14 cm
Art. Nr. 232195

■ Einbautopf, 14x14 cm
Art. Nr. 232195

Variante	Art. Nr.
Direkt: 350lm 3000K CRI80	
■ anthrazit	232155

Variante	Art. Nr.
Direkt: 700lm 3000K CRI80	
■ anthrazit	232165



232165 572

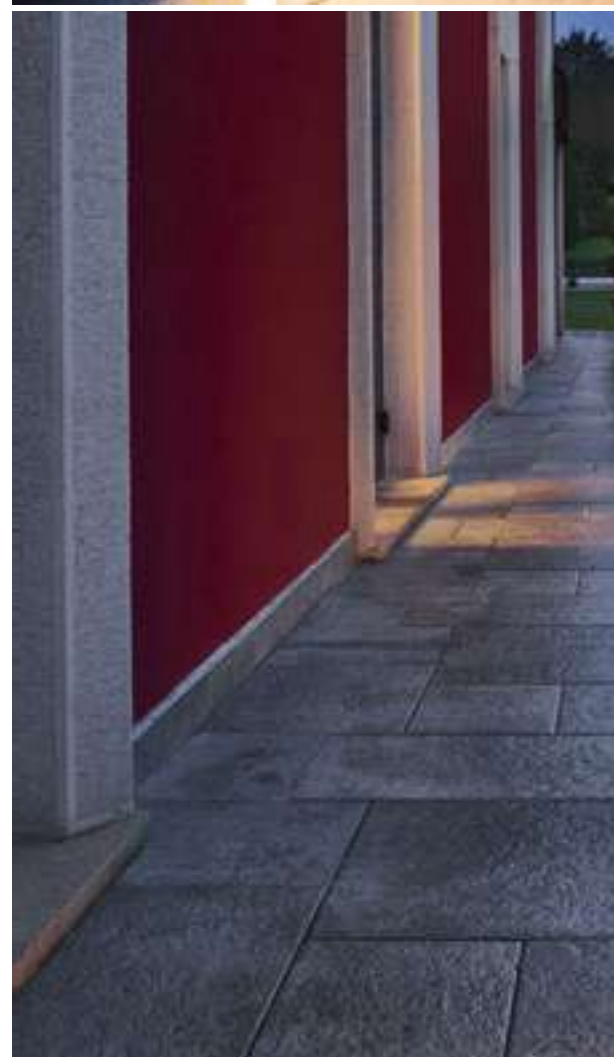



232175 573

H-POL TWIN 30 Pole

H-POL TWIN 60 Pole

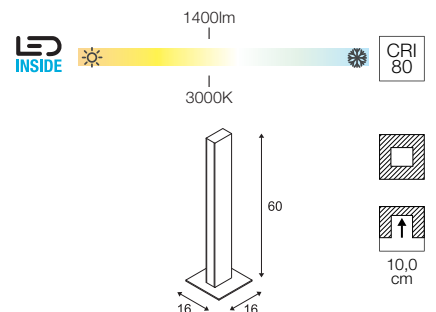
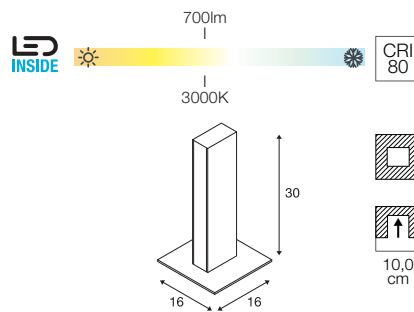

IP 55 L70B50 18

IP 55 L70B50 9

100-277V ~50/60Hz | 500mA
 Systemleistung: 18W
 Material: Aluminium / Kunststoff

220-240V ~50/60Hz | 1000mA
 Systemleistung: 35W
 Material: Aluminium / Kunststoff

- Das Produkt ist zum Bodeneinbau vorgesehen.
- Einbautopf inkl.
- Zur optionalen Montage im Erdreich steht ein größerer Einbautopf zur Verfügung.
 Einbaumaße des optionalen Einbautopfes:
 L: 14 cm B: 14 cm T:16 cm

- Das Produkt ist zum Bodeneinbau vorgesehen.
- Einbautopf inkl.
- Zur optionalen Montage im Erdreich steht ein größerer Einbautopf zur Verfügung.
 Einbaumaße des optionalen Einbautopfes:
 L: 14 cm B: 14 cm T:16 cm

		A → G
Direkt	350lm 3000K	A T G E

		A → G
Direkt	700lm 3000K	A T G E

Einbautopf, 14x14 cm
Art. Nr. 232195

Einbautopf, 14x14 cm
Art. Nr. 232195

Variante	Art. Nr.
Direkt: 350lm 3000K CRI80	
Direkt: 350lm 3000K CRI80	
anthrazit	232175

Variante	Art. Nr.
Direkt: 700lm 3000K CRI80	
Direkt: 700lm 3000K CRI80	
anthrazit	232185

SLOTBOX 40
Pole

SLOTBOX 70
Pole

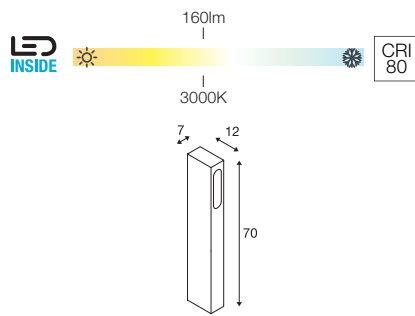
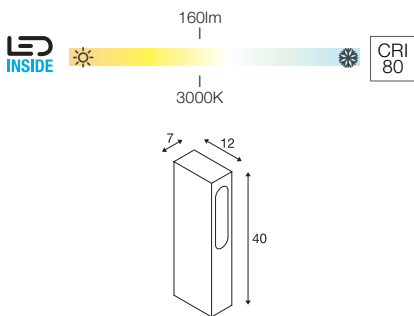

IP 44 IK04 L70B50

IP 44 IK04 L70B50

100-240V ~50/60Hz | 700mA
Systemleistung: 8W
Material: Aluminium

100-240V ~50/60Hz | 700mA
Systemleistung: 8,7W
Material: Aluminium

- Offenes Kabelende

- Offenes Kabelende

232135	160lm 3000K	

232145	160lm 3000K	

Verbindungsbox IP68, 3-polig
Art. Nr. 228730

Verbindungsbox IP68, 3-polig
Art. Nr. 228730

Variante	Art. Nr.
160lm 3000K CRI80 ■ anthrazit	232135

Variante	Art. Nr.
160lm 3000K CRI80 ■ anthrazit	232145



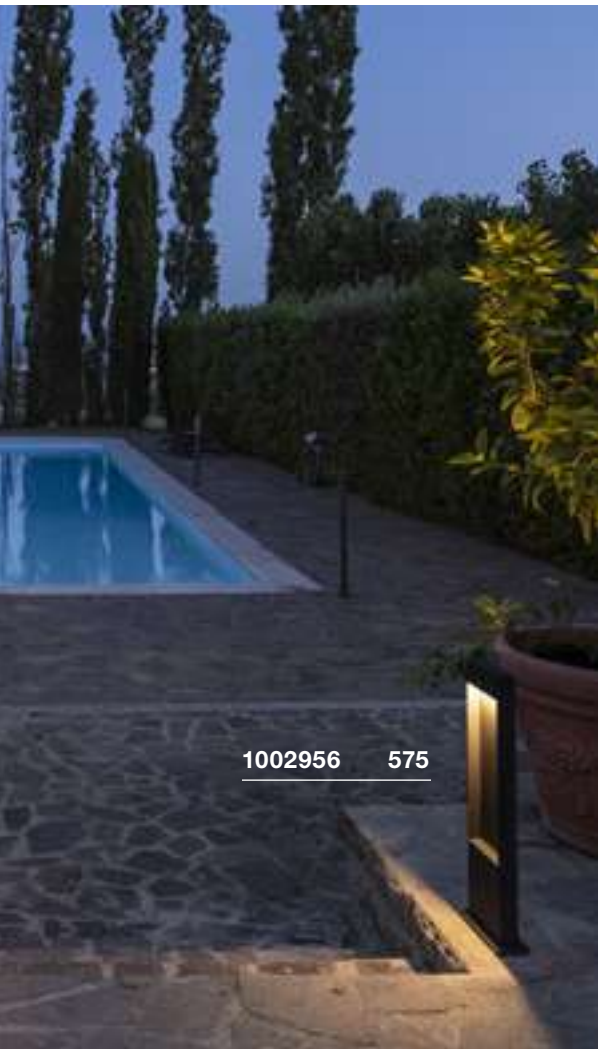

1002956 575

FLATT 65 POLE

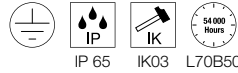
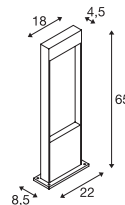

100-240V ~50/60Hz | 350mA
Systemleistung: 9,7W
Material: Aluminium

- Lichtfarbe durch Schalter im Gehäuse vor der Installation wählbar.



1002956, 1002957	400lm 3000/4000K	



■ Verbindungsbox IP68, 3-polig
Art. Nr. 228730

Variante	Art. Nr.
400lm 3000/4000K CRI80	
■ anthrazit / anthrazit	1002956
400lm 3000/4000K CRI80	
■ anthrazit / braun	1002957

FLATT 100 POLE

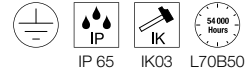
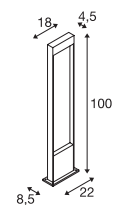
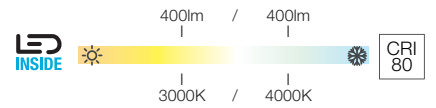

100-240V ~50/60Hz | 350mA
Systemleistung: 9,7W
Material: Aluminium

- Lichtfarbe durch Schalter im Gehäuse vor der Installation wählbar.



1002958, 1002959	400lm 3000/4000K	



■ Verbindungsbox IP68, 3-polig
Art. Nr. 228730

Variante	Art. Nr.
400lm 3000/4000K CRI80	
■ anthrazit / anthrazit	1002958
400lm 3000/4000K CRI80	
■ anthrazit / braun	1002959

ABRIDOR 60
Pole



ABRIDOR 100
Pole

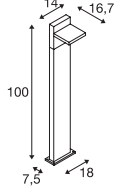
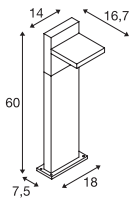
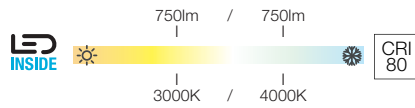
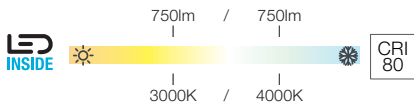
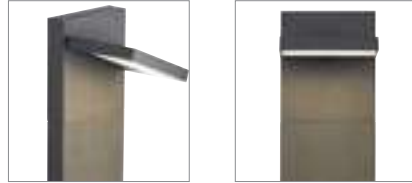

100-277V ~50/60Hz | 300mA
Systemleistung: 14W
Material: Aluminium



100-277V ~50/60Hz | 300mA
Systemleistung: 14W
Material: Aluminium



1002991	750lm 3000/4000K	



1002992	750lm 3000/4000K	



■ Verbindungsbox IP68, 3-polig
Art. Nr. **228730**



■ Verbindungsbox IP68, 3-polig
Art. Nr. **228730**



Variante	Art. Nr.
750lm 3000/4000K CRI80	
■ anthrazit	1002991

Variante	Art. Nr.
750lm 3000/4000K CRI80	
■ anthrazit	1002992



1002992 576



231305 577



232295 577

IPERI 50
Pole

QUADRASYL 75
Pole, TCR-TSE

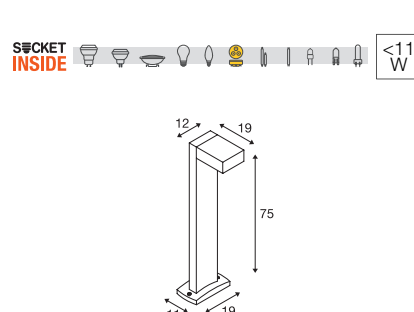
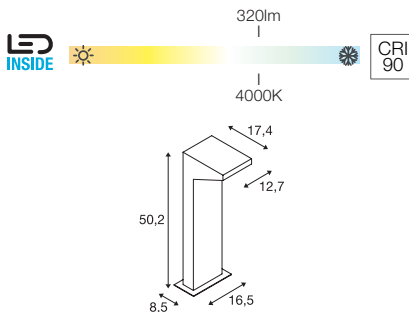

LED INSIDE CRI 90

IP 44 L70B50

230V ~50Hz
Systemleistung: 5W
Material: Aluminium / Kunststoff

SOCKET INSIDE <11 W

IP 44

220-240V ~50/60Hz
Material: Aluminium

- Betonanker inkl.
- Offenes Kabelende

		A → G
231305	400lm 4000K	A 1 G D

GX53 <11W
Ø: 7,5 cm L: 2,7 cm

LED GX53 | 6,1W | 120°
4000K | 520lm | EEK=F
6kWh/1000h

Art. Nr. 1005269

Erdspieß
Art. Nr. 231231

T-Verbinderbox
Art. Nr. 228726

Variante	Art. Nr.
320lm 4000K CRI90 ■ anthrazit	231305

Variante	Art. Nr.
1xGX53 ■ anthrazit	232295
1xGX53 ■ grau	232294

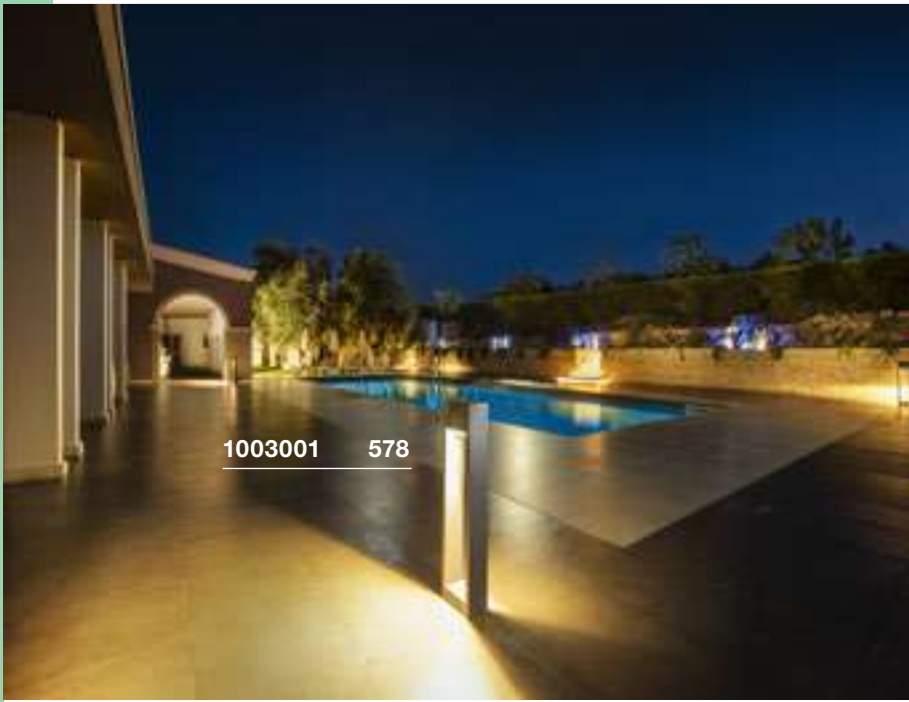

1003001 578



1005441 579

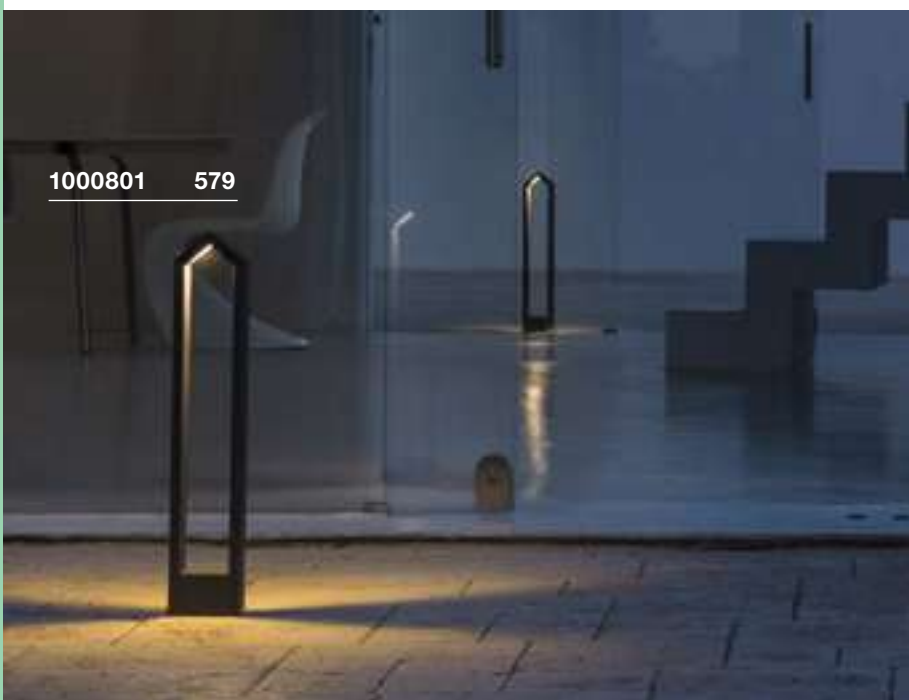

1000801 579

QUAD POLE

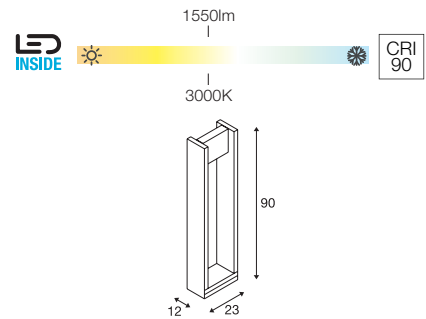

100-277V ~50/60Hz | 500mA
 Systemleistung: 18W
 Material: Aluminium / Glas

- Offenes Kabelende

		A → G
1003001	1550lm 3000K	A G E

Verbindungsbox IP68, 3-polig
 Art. Nr. 228730

Variante	Art. Nr.
1550lm 3000K CRI90	
■ anthrazit	1003001



BOOKAT
Pole, PHASE

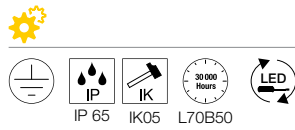
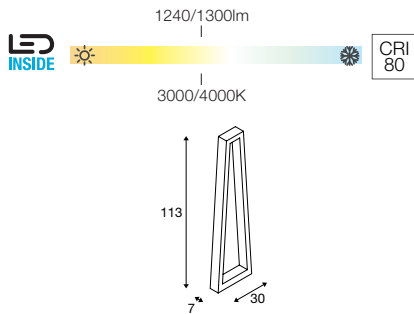

100-277V ~50/60Hz | 700mA
Systemleistung: 15W
Material: Aluminium

- inkl. IP Verbindungsbox



		A → G
1005441	1240/1300lm 3000/4000K	A T G E

Variante	Art. Nr.
1240/1300lm 3000/4000K CRI 80	
■ anthrazit	1005441

RASCALI 45
Pole

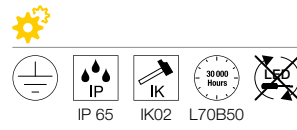
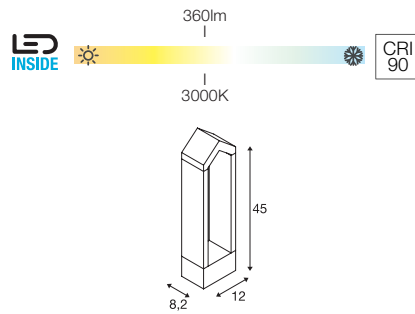

220-240V ~50/60Hz
Systemleistung: 8W
Material: Aluminium



		A → G
1000799	360lm 3000K	A T G E

Variante	Art. Nr.
360lm 3000K CRI90	
■ anthrazit	1000799

RASCALI 65
Pole

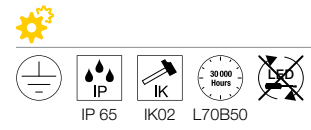
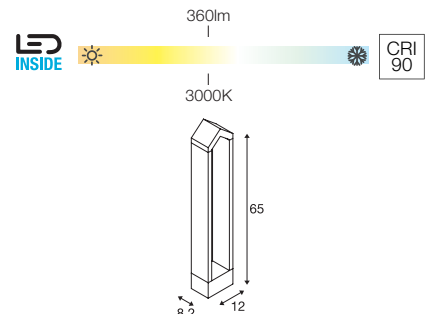

220-240V ~50/60Hz
Systemleistung: 8W
Material: Aluminium



		A → G
1000801	360lm 3000K	A T G E

Variante	Art. Nr.
360lm 3000K CRI90	
■ anthrazit	1000801

ENOLA C
POLE

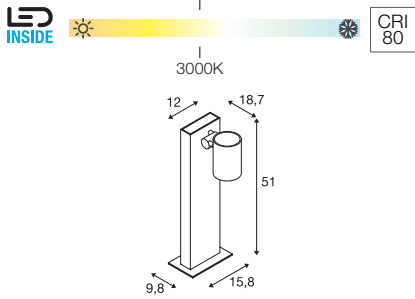

100-240V ~50/60Hz | 500mA
Systemleistung: 12W
Material: Aluminium / Glas



228545	1060lm 3000K	



Verbindungsbox IP68, 3-polig
Art. Nr. 228730



Variante	Art. Nr.
800lm 3000K CRI80 anthrazit	228545



228545 580





1002198 581



1002200 581

HELIA
Pole, single, PHASE



HELIA
Pole, double, PHASE

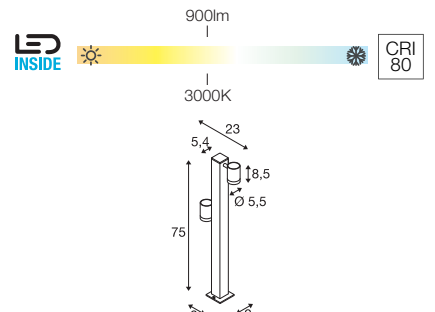
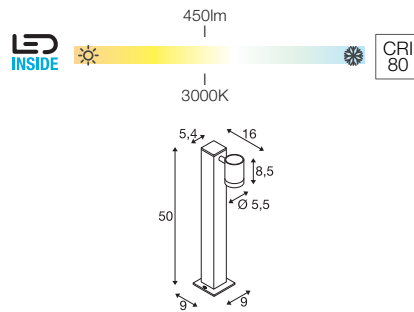

IP 55 35° L70B50 320° 90° 20

220-240V ~50/60Hz
Systemleistung: 8W
Material: Aluminium / Glas

- Offenes Kabelende

IP 55 35° L70B50 320° 90° 20

220-240V ~50/60Hz
Systemleistung: 16W
Material: Aluminium / Glas

- Offenes Kabelende

		A → G
1002198	440lm 3000K	A G E

		A → G
1002200	880lm 3000K	A G E

-
- Verbindungsbox IP68, 3-polig
Art. Nr. 228730
 - Erdspieß
Art. Nr. 1000736

-
- Verbindungsbox IP68, 3-polig
Art. Nr. 228730
 - Erdspieß
Art. Nr. 1000736

Variante	Art. Nr.
450lm 3000K CRI80 ■ anthrazit	1002198

Variante	Art. Nr.
900lm 3000K CRI80 ■ anthrazit	1002200

HELIA
Pole, single, PHASE



450lm

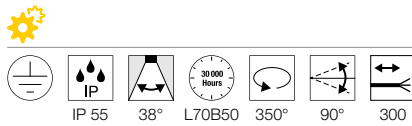
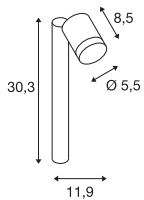

220-240V ~50/60Hz
Systemleistung: 8W
Material: Aluminium

- Die Leuchtenhöhe kann max. durch 2 Verlängerungsstäbe erhöht werden.
- Offenes Kabelende

HELIA
Pole, double, PHASE



900lm

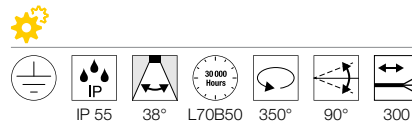
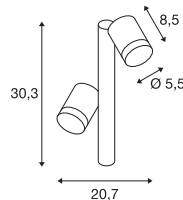
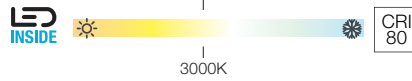

220-240V ~50/60Hz
Systemleistung: 16W
Material: Aluminium

- Die Leuchtenhöhe kann max. durch 2 Verlängerungsstäbe erhöht werden.
- Offenes Kabelende



223285 582

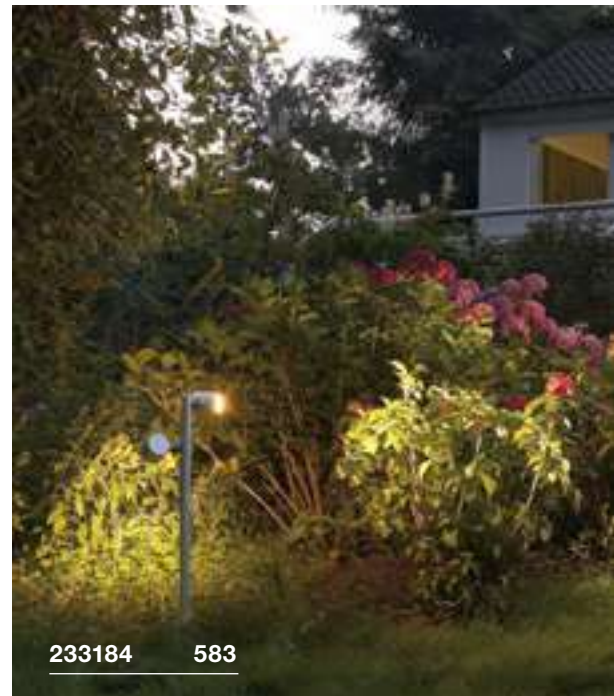

233184 583

233275	440lm 3000K	

	Art. Nr. 228712	Art. Nr. 228752	Art. Nr. 233145	Art. Nr. 233165

Variante	Art. Nr.
450lm 3000K CRI80 ■ anthrazit	233275

233285	880lm 3000K	

	Art. Nr. 228712	Art. Nr. 228752	Art. Nr. 233145	Art. Nr. 233165

Variante	Art. Nr.
900lm 3000K CRI80 ■ anthrazit	233285



231505 583



MYRA SPOT
Double, GU10



MYRA SPOT
Double, GU10



SITRA 360
Pole, TCR-TSE

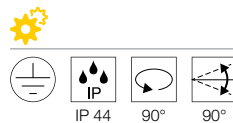
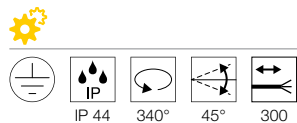
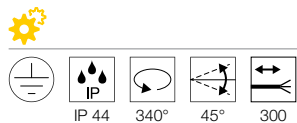
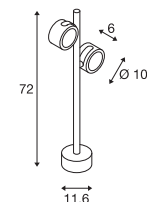
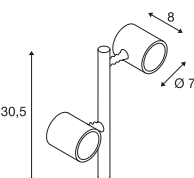
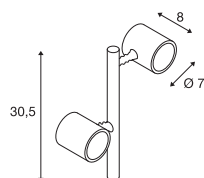

220-240V ~50/60Hz
Material: Aluminium

220-240V ~50/60Hz
Material: Aluminium

220-240V ~50/60Hz
Material: Aluminium / Glas

- Die Leuchtenhöhe kann max. durch 2 Verlängerungsstäbe erhöht werden.
- Offenes Kabelende

- Die Leuchtenhöhe kann max. durch 2 Verlängerungsstäbe erhöht werden.
- Offenes Kabelende

GU10 <4,5W
Ø: 5 cm L: 5,7 cm

GU10 <4,5W
Ø: 5 cm L: 5,7 cm

GX53 <9W
Ø: 7,5 cm L: 3,5 cm

LED GU10 51mm | 4W | 36°
2700K | 270lm | EEK=G
4kWh/1000h



LED GU10 51mm | 4W | 36°
3000K | 270lm | EEK=G
4kWh/1000h



LED GX53 | 6W | 120°
4000K | 550lm | EEK=F
6kWh/1000h



Art. Nr. 1004972

Art. Nr. 1004973

Art. Nr. 1005269

- Betonanker
Art. Nr. 228712
- Schraubenset
Art. Nr. 228752
- Standfuß
Art. Nr. 233144
- Verlängerungsstab
Art. Nr. 233164

- Betonanker
Art. Nr. 228712
- Schraubenset
Art. Nr. 228752
- Standfuß
Art. Nr. 233145
- Verlängerungsstab 30 cm
Art. Nr. 233165

- Erdspließ
Art. Nr. 230060

Variante	Art. Nr.
2xGU10	
■ grau	233184

Variante	Art. Nr.
2xGU10	
■ anthrazit	233185

Variante	Art. Nr.
2xGX53	
■ anthrazit	231505

DA GEHT DIE SONNE AUF.

STRAHLER SETZEN DYNAMISCHE LICHTAKZENTE.

Sie möchten einen Außenbereich effektiv beleuchten?
Dann entdecken Sie gleich die große Vielfalt an Strahlern, die eine ganz individuelle Beleuchtung ermöglichen. Zum Beispiel an Gebäuden, auf Plätzen, Wegen oder in Gärten.



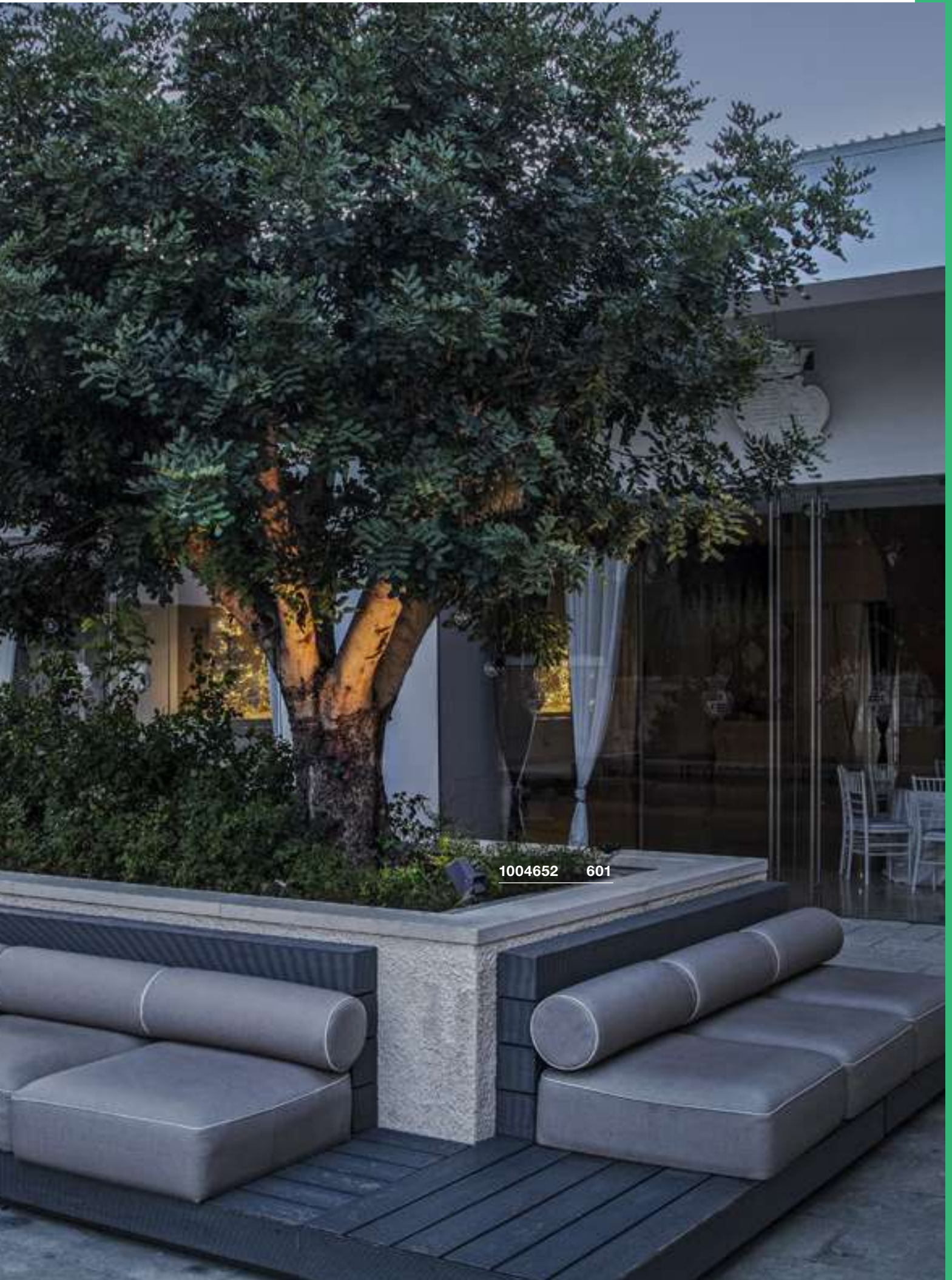

1004652 601





















1004757 592



1006192 589

STRAHLER

NEW  589	NEW  589	NEW  589	 591	 591	 591	 592	 593
 593	 594	 595	 595	 595	 597	 598	 598
 599	 599	 601	 601	 601	 603		



Weitere Leuchten und Varianten finden Sie online unter www.slv.com
 Herstellerangaben unserer Leuchtmittelempfehlungen finden Sie im Kapitel Leuchtmittel ab Seite 808



1006193 589

FLOODI S
SP

NEW

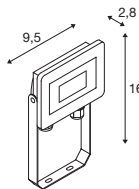
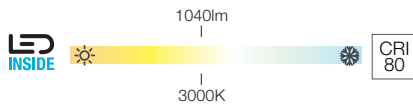

220-240V ~50/60Hz
Systemleistung: 9,3W
Material: Aluminium / Glas

FLOODI M
SP

NEW

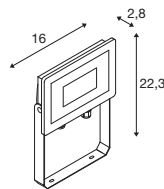
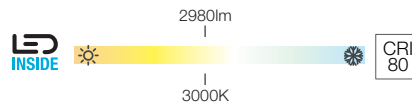

220-240V ~50/60Hz
Systemleistung: 30W
Material: Aluminium / Glas

FLOODI L
SP

NEW

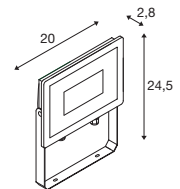
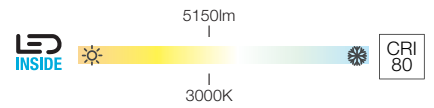

220-240V ~50/60Hz
Systemleistung: 48W
Material: Aluminium / Glas

1006191	1040lm 3000K	

Variante	Art. Nr.
1040lm 3000K CRI80 ■ anthrazit	1006191 ■

1006192	2980lm 3000K	

Variante	Art. Nr.
2980lm 3000K CRI80 ■ anthrazit	1006192 ■

1006193	5150lm 3000K	

Variante	Art. Nr.
5150lm 3000K CRI80 ■ anthrazit	1006193 ■



1003448 591



GALEN 60 SP

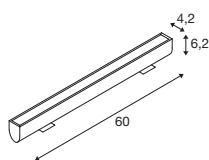
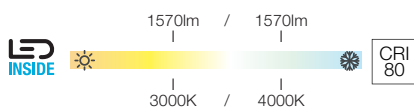

IP 65 IK03 L70B50 180° 11 12

220-240V ~50/60Hz | 450mA
Systemleistung: 18W
Material: Aluminium / Glas

1003447	1570/1570lm 3000/4000K	

Variante	Art. Nr.
1570/1570lm 3000/4000K CRI80	
anthrazit	1003447

GALEN 120 SP

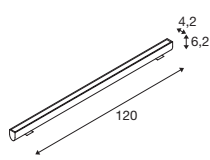
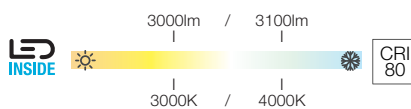

IP 65 IK03 L70B50 180° 11 10

220-240V ~50/60Hz | 900mA
Systemleistung: 34W
Material: Aluminium / Glas

1003448	3000/3100lm 3000/4000K	

Variante	Art. Nr.
3000/3100lm 3000/4000K CRI80	
anthrazit	1003448

FLAC BEAM® SP

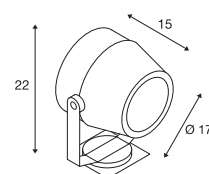

IP 65 IK04 60° L70B50 120° 170°

200

220-240V ~50/60Hz
Systemleistung: 27W
Material: Aluminium

• IP44 Schutzkontaktstecker

Die Informationen zur Energieeffizienzklasse für dieses Produkt lagen bei Druck noch nicht vor. Die aktuellsten Produktdaten finden Sie jederzeit unter www.slv.com

Variante	Art. Nr.
1800lm 3000K CRI90	
grau	231072

SAMRINA
SP, single, GU10

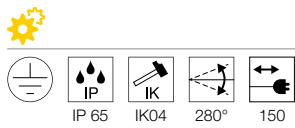
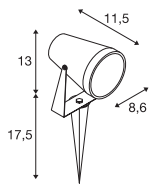

220-240V ~50/60Hz
Material: Kunststoff / Glas

- Enthält recyceltes Material
- IP 44 Schutzkontaktstecker

GU10 7W
Ø: 6 cm L: 6 cm

LED GU10 51mm | 4W | 36°
2700K | 270lm | EEK=G
4kWh/1000h



Art. Nr. 1004972

Variante	Art. Nr.
GU10	
■ schwarz	1004757

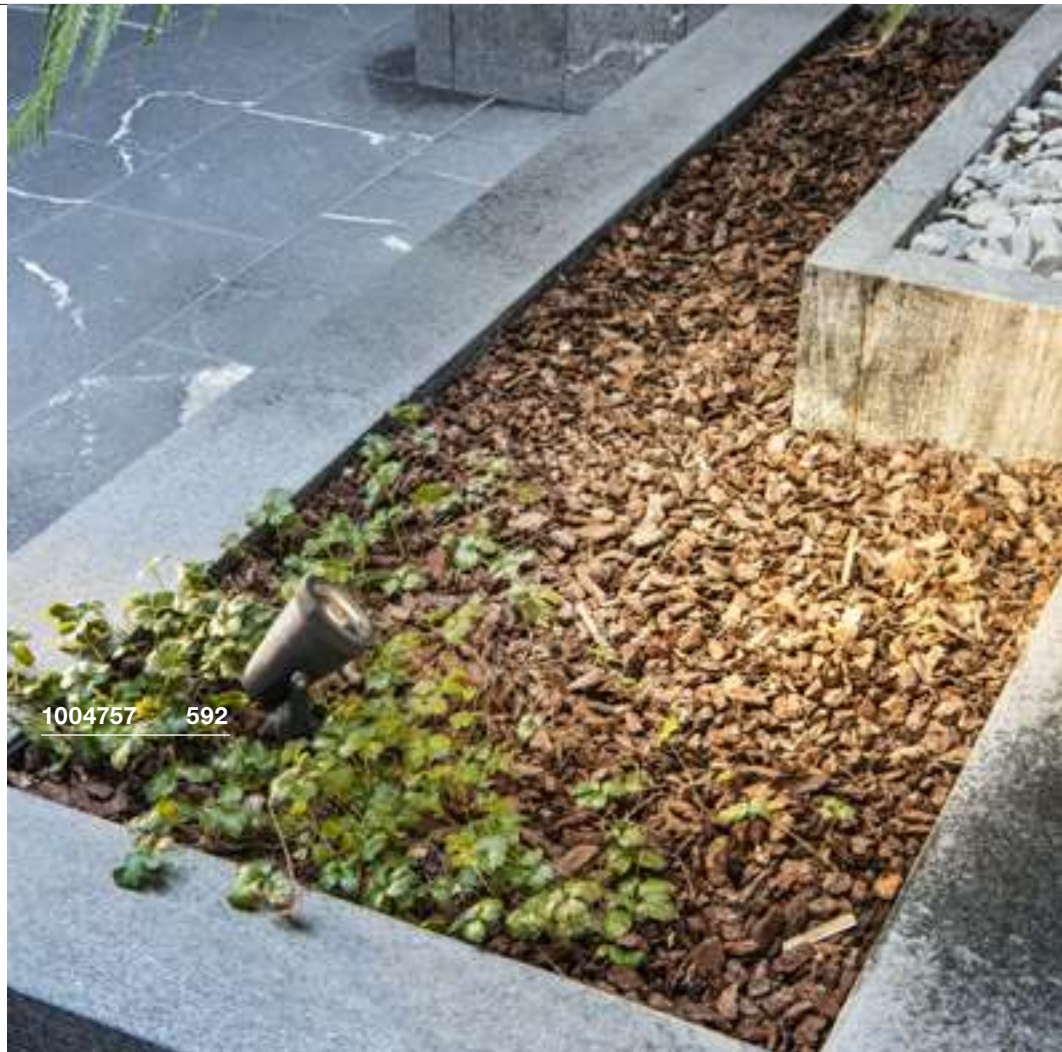

1004757 592





227418 593



227410 593

NAUTILUS 10
SP, rund, QPAR51



BIG NAUTILUS
SP, rund, QPAR51

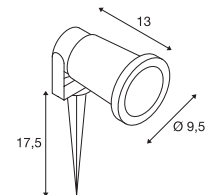
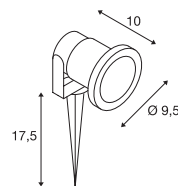

220-240V ~50/60Hz
Material: Aluminium

- IP44 Schutzkontaktstecker

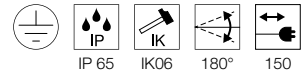

230V ~50Hz
Material: Aluminium

- IP44 Schutzkontaktstecker



GU10 <35W
L: 5,7 cm



LED GU10 51mm | 4W | 36°
3000K | 270lm | EEK=G
4kWh/1000h

Art. Nr. 1004973



GU10 <11W
Ø: 5 cm L: 8,3 cm



LED GU10 51mm | 4W | 36°
4000K | 270lm | EEK=G
4kWh/1000h

Art. Nr. 1004974

Variante	Art. Nr.
1xGU10	
■ grau	227418

Variante	Art. Nr.
1xGU10	
■ schwarz	227410
■ rost	1001964
■ grün	1001965

NAUTILUS 10
SP, rund, QPAR51



SOCKET INSIDE <25 W

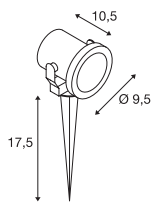

220-240V ~50/60Hz
Material: Edelstahl 316

- IP44 Schutzkontaktstecker



GU10 <25W
Ø: 5 cm L: 5,7 cm



LED GU10 51mm | 4W | 36°
2700K | 270lm | EEK=G
4kWh/1000h



Art. Nr. 1004972

Variante	Art. Nr.
1xGU10	
■ edelstahl	229740



229090 595



229741 595

NAUTILUS
SP, QR-C51



NAUTILUS 10 SPOT
SP, QPAR51



NAUTILUS 10 SPOT LED
SP

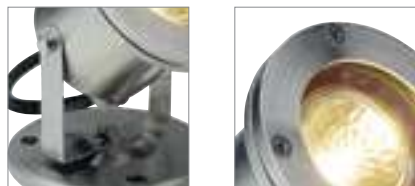

<35 W



<25 W

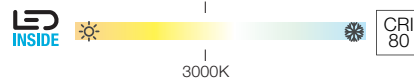

520lm
3000K
CRI 80

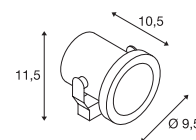
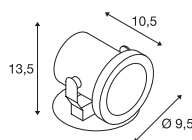
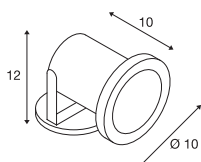

IP 67 IK03 180° 150

12V ~50Hz
Material: Edelstahl 304 / Glas

- offenes Kabelende



IP 55 IK03 360° 180° 150

220-240V ~50/60Hz
Material: Edelstahl 316

- offenes Kabelende

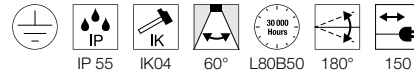

IP 55 IK04 60° L80B50 180° 150



220-240V ~50/60Hz
Systemleistung: 9W
Material: Edelstahl 316

- IP44 Schutzkontaktstecker



GX5,3 <35W



LED GU5,3 | 5,5W | 36°
2700K | 450lm | EEK=G
7kWh/1000h

Art. Nr. 1001574



GU10 <25W
Ø: 5 cm L: 6 cm



LED GU10 51mm | 4W | 36°
3000K | 270lm | EEK=G
4kWh/1000h

Art. Nr. 1004973



■ Transformator 12V AC | 60VA IP44
Art. Nr. 227160



■ Verbindungsbox IP68, 3-polig
Art. Nr. 228730



■ Erdspeiß
Art. Nr. 900011
■ Montage Platte
Art. Nr. 1001963



Variante	Art. Nr.
1xGX5,3	
■ edelstahl	229090

Variante	Art. Nr.
1xGU10	
■ edelstahl	229741

Variante	Art. Nr.
520lm 3000K CRI80	
■ edelstahl	1001962



231035 597



NAUTILUS 10
SP, quadratisch



660lm



CRI 80

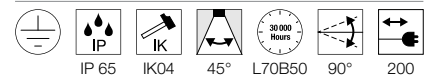
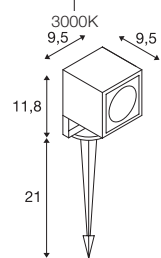

100-277V ~50/60Hz | 700mA
Systemleistung: 8.5W
Material: Aluminium / Glas

- IP44 Schutzkontaktstecker



		A → G
231035, 1001937	660lm 3000K	

Variante	Art. Nr.
660lm 3000K CRI80	
anthrazit	231035
660lm 3000K CRI80	
rost	1001937

DASAR® PROJECTOR
SP, 12/24V

DASAR® PROJECTOR
SP, 230V

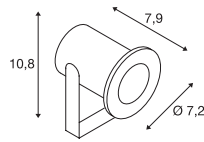
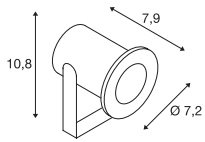
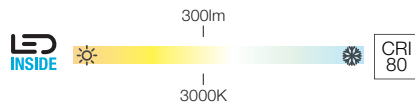
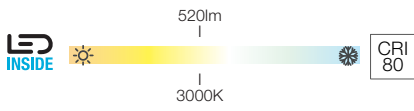

12-24V
Systemleistung: 6.5W
Material: Edelstahl 316 / Glas

220-240V ~50/60Hz | 400mA
Systemleistung: 4.6W
Material: Edelstahl 316 / Glas

- offenes Kabelende

- IP44 Schutzkontaktstecker

233570	520lm 3000K	

233571	300lm 3000K	

- Erdspieß Edelstahl 316
Art. Nr. 233580
- Montageplatte Edelstahl316
Art. Nr. 233582
- Erdspieß Kunststoff
Art. Nr. 900011

- Erdspieß Edelstahl 316
Art. Nr. 233580
- Montageplatte Edelstahl316
Art. Nr. 233582
- Erdspieß Kunststoff
Art. Nr. 900011

Variante	Art. Nr.
520lm 3000K CRI80	
edelstahl	233570

Variante	Art. Nr.
300lm 3000K CRI80	
edelstahl	233571

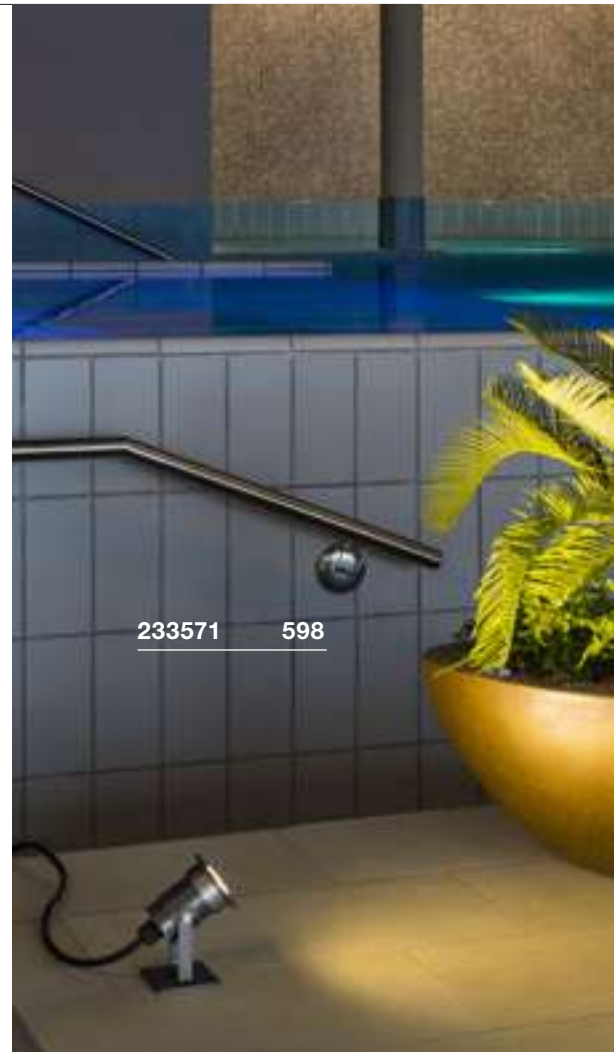



1000735 599



228555 599

HELIA SPOT S
SP, single, PHASE



HELIA SPOT L
SP, single, PHASE

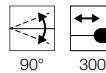
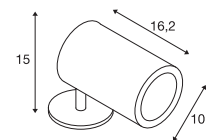
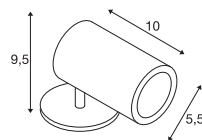
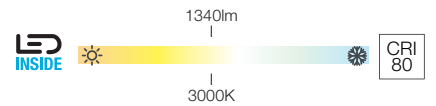
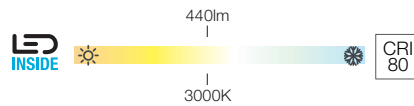
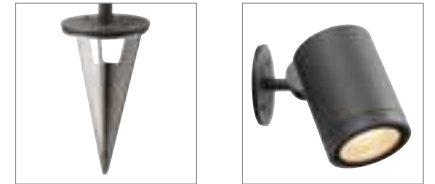

220-240V ~50/60Hz | 500mA
Systemleistung: 6.5W
Material: Aluminium

- IP44 Schutzkontaktstecker

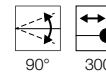

220-240V ~50/60Hz | 700mA
Systemleistung: 15W
Material: Aluminium

- IP44 Schutzkontaktstecker



		A → G
1000735	440lm 3000K	A f G E



		A → G
228555	1340lm 3000K	A f G E



■ Erdspieß
Art. Nr. 1000736



■ Erdspieß
Art. Nr. 1000736

Variante	Art. Nr.
440lm 3000K CRI80	
■ anthrazit	1000735

Variante	Art. Nr.
1340lm 3000K CRI80	
■ anthrazit	228555



1004652 601



1002201 601

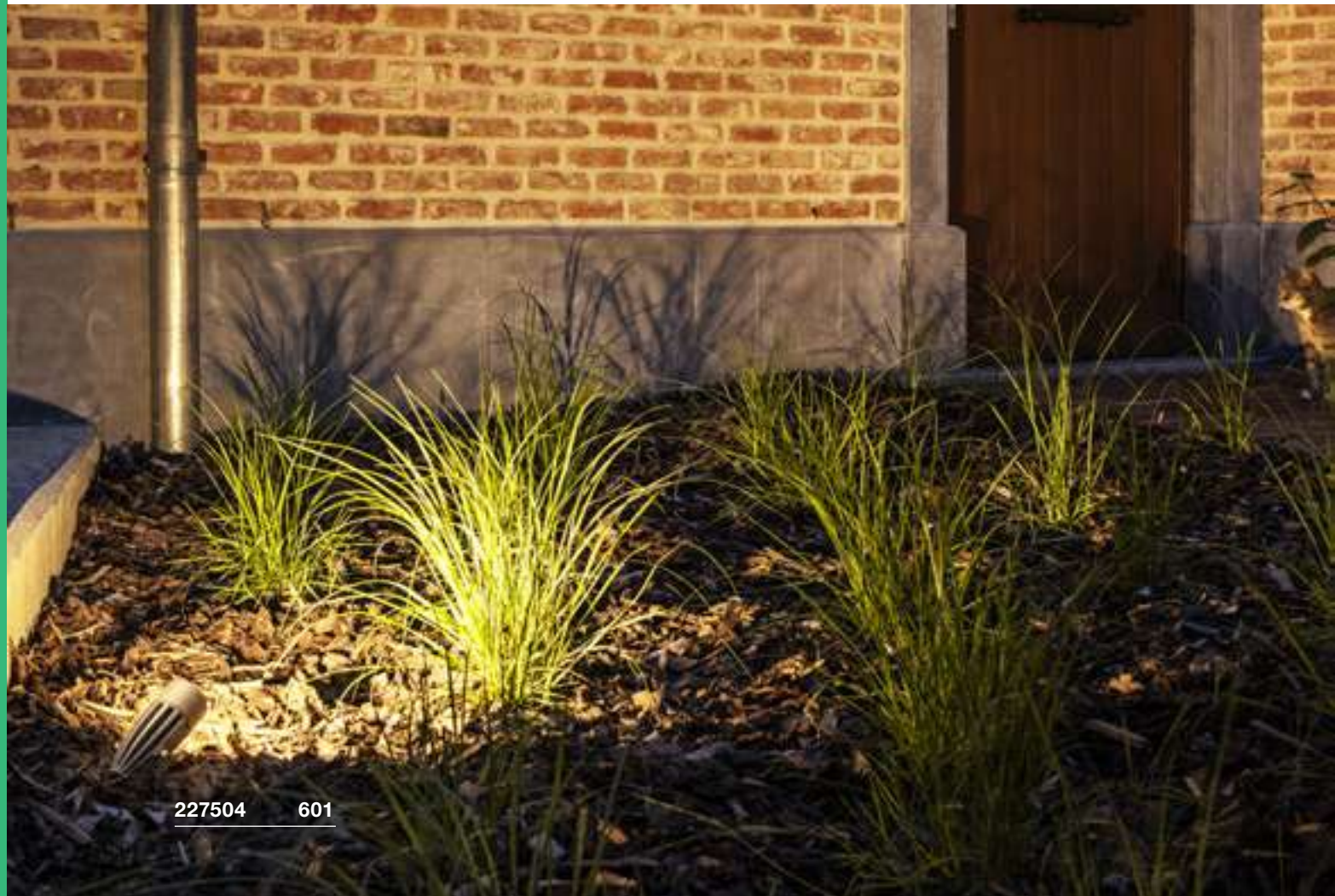

227504 601

THEO BRACKET SP



SYNA SP

LED SPIKE SP

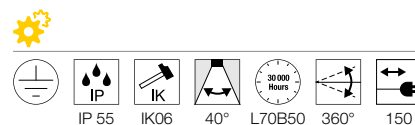
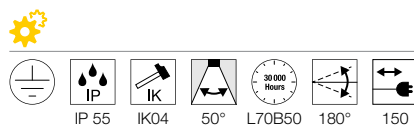
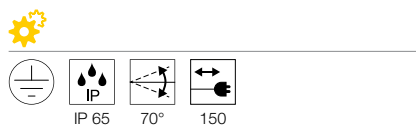
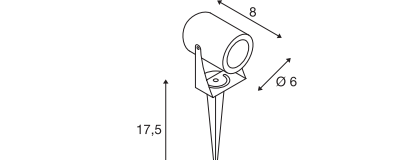
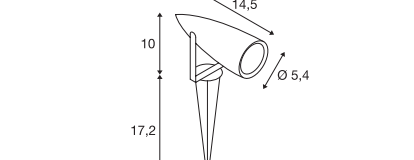
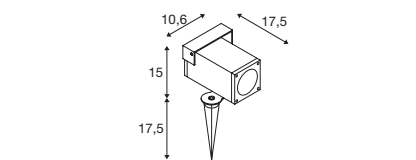
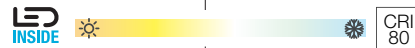
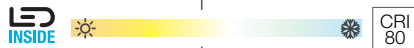
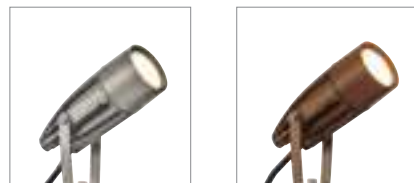
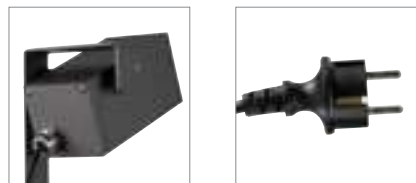

220-240V ~50/60Hz
Material: Aluminium / Glas

220-240V ~50/60Hz
Systemleistung: 9W
Material: Aluminium / Glas

100-240V ~50/60Hz | 240mA
Systemleistung: 6W
Material: Aluminium / Glas

- IP 44 Schutzkontaktstecker

- IP44 Schutzkontaktstecker

- IP44 Schutzkontaktstecker

GU10 <7W
Ø: 5,1 cm L: 5,7 cm

LED GU10 51mm | 4W | 36°
2700K | 270lm | EEK=G
4kWh/1000h

Art. Nr. 1004972

Variante	Art. Nr.
1xGU10	
■ anthrazit	1004652

Art. Nr.	470lm 3000K	A → G
227505, 227504, 227507		A → G

Variante	Art. Nr.
470lm 3000K CRI80	
■ anthrazit	227505
470lm 3000K CRI80	
■ grau	227504
470lm 3000K CRI80	
■ rost	227507

Art. Nr.	400lm 3000K	A → G
1002201, 1002203		A → G

Variante	Art. Nr.
400lm 3000K CRI80	
■ anthrazit	1002201
400lm 3000K CRI80	
■ rost	1002203

SITRA 360 SPIKE
SP, single, TCR-TSE

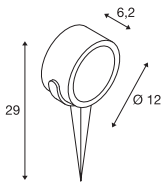

220-240V ~50/60Hz
Material: Aluminium / Glas

- IP44 Schutzkontaktstecker



GX53 <math><9\text{ W}</math>
Ø: 7,5 cm L: 3,5 cm



LED GX53 | 6,1W | 120°
2700K | 490lm | EEK=G
6kWh/1000h



Art. Nr. 1005272

Variante	Art. Nr.
1xGX53	
■ anthrazit	231525



231525 602



231535 603

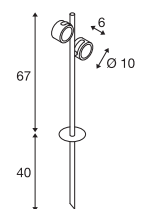

231535 603

SITRA 360 SPIKE
SP, double, TCR-TSE

IP 44

IK04

90°

90°

150

220-240V ~50/60Hz
Material: Aluminium / Glas

- IP44 Schutzkontaktstecker

GX53 <9W
Ø: 7,5 cm L: 3,5 cmLED GX53 | 6,1W | 120°
3000K | 490lm | EEK=G
6kWh/1000h

Art. Nr. 1005271

Variante	Art. Nr.
2xGX53 ■ anthrazit	231535

BRINGEN LICHT INS DUNKEL.

PRAKTISCHE WAND- UND DECKENLEUCHTEN.

Die strahlen sogar noch bei den schlechtesten Wetterverhältnissen: Unsere Wand- und Deckenleuchten sind robust, energieeffizient und leistungsstark. Neben all der Funktionalität können Sie aber auch noch zwischen verschiedenen Designs auswählen. Soll es eher modern sein? Traditionell? Rund? Oder lieber eckig?



234515 619





234525 620



1002403 629

WAND- UND DECKENLEUCHTEN

 611	 611	 611	 612	 612	 612	 615	 615
 615	 616	 616	 616	 618	 619	 619	 619
 620	 621	 621	 622	 622	 622	 624	 624
 624	 626	 626	 627	 627	 629	 629	 629
 630	 630	 631	 631	 632	 633	 633	 634
 634	 635	 636	 636	 637	 637	 638	 639
 639	 639	 640	 640	 641	 641	 642	 642
 643	 643	 643	 644	 644	 644	 645	 645

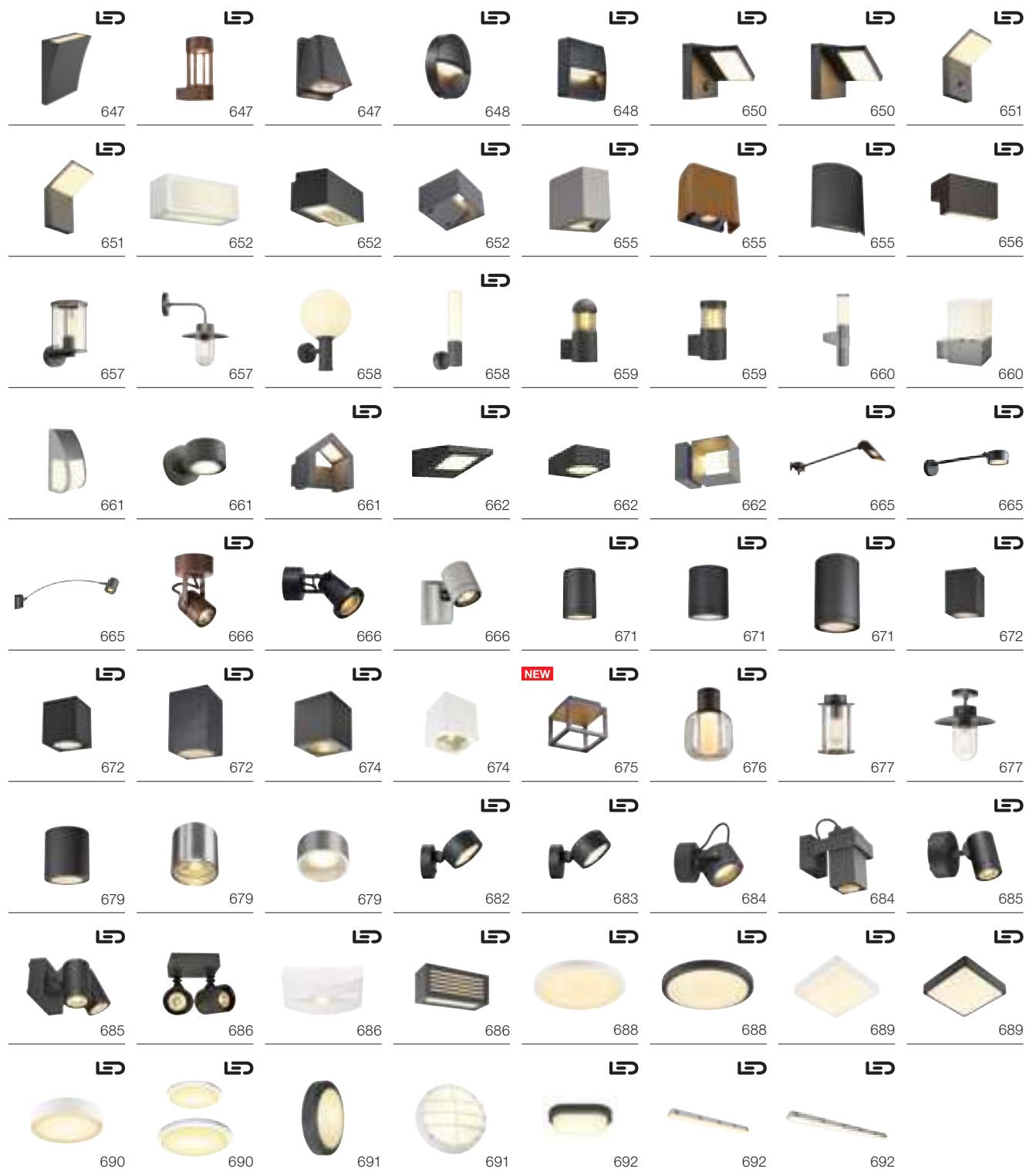

Weitere Leuchten und Varianten finden Sie online unter www.slv.com
 Herstellerangaben unserer Leuchtmittelempfehlungen finden Sie Im Kapitel Leuchtmittel ab Seite 808

WANDLEUCHTEN



1003442 671



234515 619

234525 620



1003423 + 1005206 611 + 617

1003423 + 1005207 611 + 617



ENOLA ROUND S
WL, single

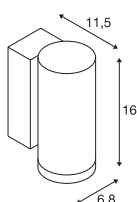
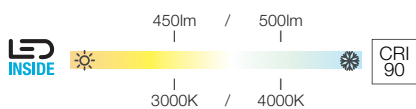

100-240V ~50/60Hz | 500mA
Systemleistung: 6W
Material: Aluminium / Glas

ENOLA ROUND M
WL, single

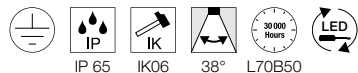
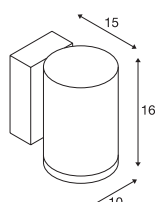
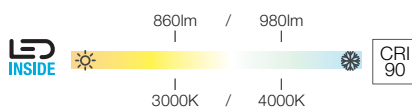

220-240V ~50/60Hz | 500mA
Systemleistung: 11W
Material: Aluminium / Glas

ENOLA ROUND L
WL, single

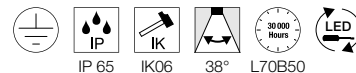
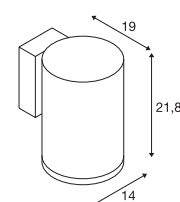
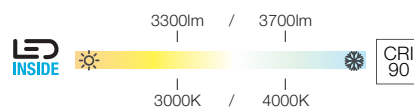

220-240V ~50/60Hz | 900mA
Systemleistung: 36W
Material: Aluminium / Glas



1003422	450/500lm 3000/4000K	A → G E
---------	-------------------------	------------



1003423	860/980lm 3000/4000K	A → G E
---------	-------------------------	------------



1003440	3300/3700lm 3000/4000K	A → G E
---------	---------------------------	------------



Abstandshalter Art. Nr. 1002853	
Reflektor 60° Art. Nr. 1005262	



Abstandshalter Art. Nr. 1002853	
Linse 19° Art. Nr. 1005205	
Linse asymmetrisch Art. Nr. 1005206	
Reflektor 60° Art. Nr. 1005207	



Abstandshalter Art. Nr. 1002853	
Reflektor 60° Art. Nr. 1005263	

Variante	Art. Nr.
450/500lm 3000/4000K CRI90	
anthrazit	1003422

Variante	Art. Nr.
860/980lm 3000/4000K CRI90	
anthrazit	1003423

Variante	Art. Nr.
3300/3700lm 3000/4000K CRI90	
anthrazit	1003440

ENOLA ROUND S
UP/DOWN
WL



620lm / 700lm

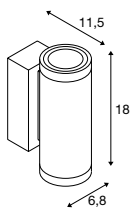

220-240V ~50/60Hz | 350mA
Systemleistung: 7.8W
Material: Aluminium / Glas

ENOLA ROUND M
UP/DOWN
WL



1660lm / 1900lm

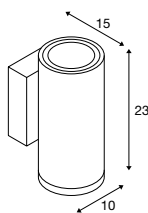

220-240V ~50/60Hz | 500mA
Systemleistung: 20W
Material: Aluminium / Glas

ENOLA ROUND L
UP/DOWN
WL



5400lm / 6000lm

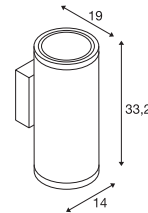

220-240V ~50/60Hz | 700mA
Systemleistung: 55W
Material: Aluminium / Glas

Up/Down	310/350lm 3000/4000K	
---------	-------------------------	--

-
- Abstandshalter
Art. Nr. 1002853
 - Reflektor 60°
Art. Nr. 1005262

Up/Down	830/950lm 3000/4000K	
---------	-------------------------	--

-
- Abstandshalter
Art. Nr. 1002853
 - Linse 19°
Art. Nr. 1005205
 - Linse asymmetrisch
Art. Nr. 1005206
 - Reflektor 60°
Art. Nr. 1005207

Up/Down	2700/3000lm 3000/4000K	
---------	---------------------------	--

-
- Abstandshalter
Art. Nr. 1002853
 - Reflektor 60°
Art. Nr. 1005263

Variante	Art. Nr.
Up: 310/350lm 3000/4000K CRI90 Down: 310/350lm 3000/4000K CRI90	
■ anthrazit	1003424

Variante	Art. Nr.
Up: 830/950lm 3000/4000K CRI90 Down: 830/950lm 3000/4000K CRI90	
■ anthrazit	1003425

Variante	Art. Nr.
Up: 2700/3000lm 3000/4000K CRI90 Down: 2700/3000lm 3000/4000K CRI90	
■ anthrazit	1003441



1003424 612



1003441 612

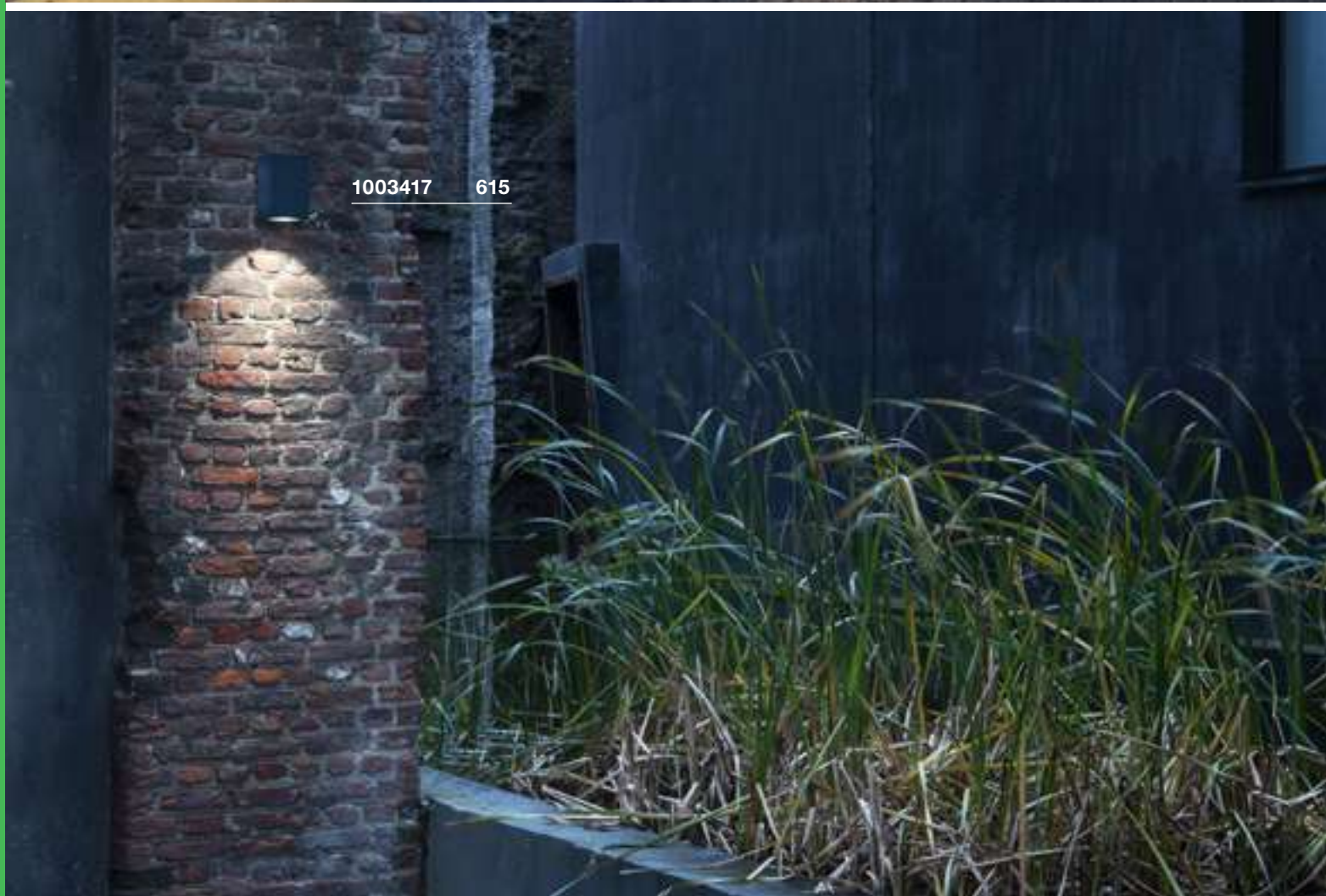
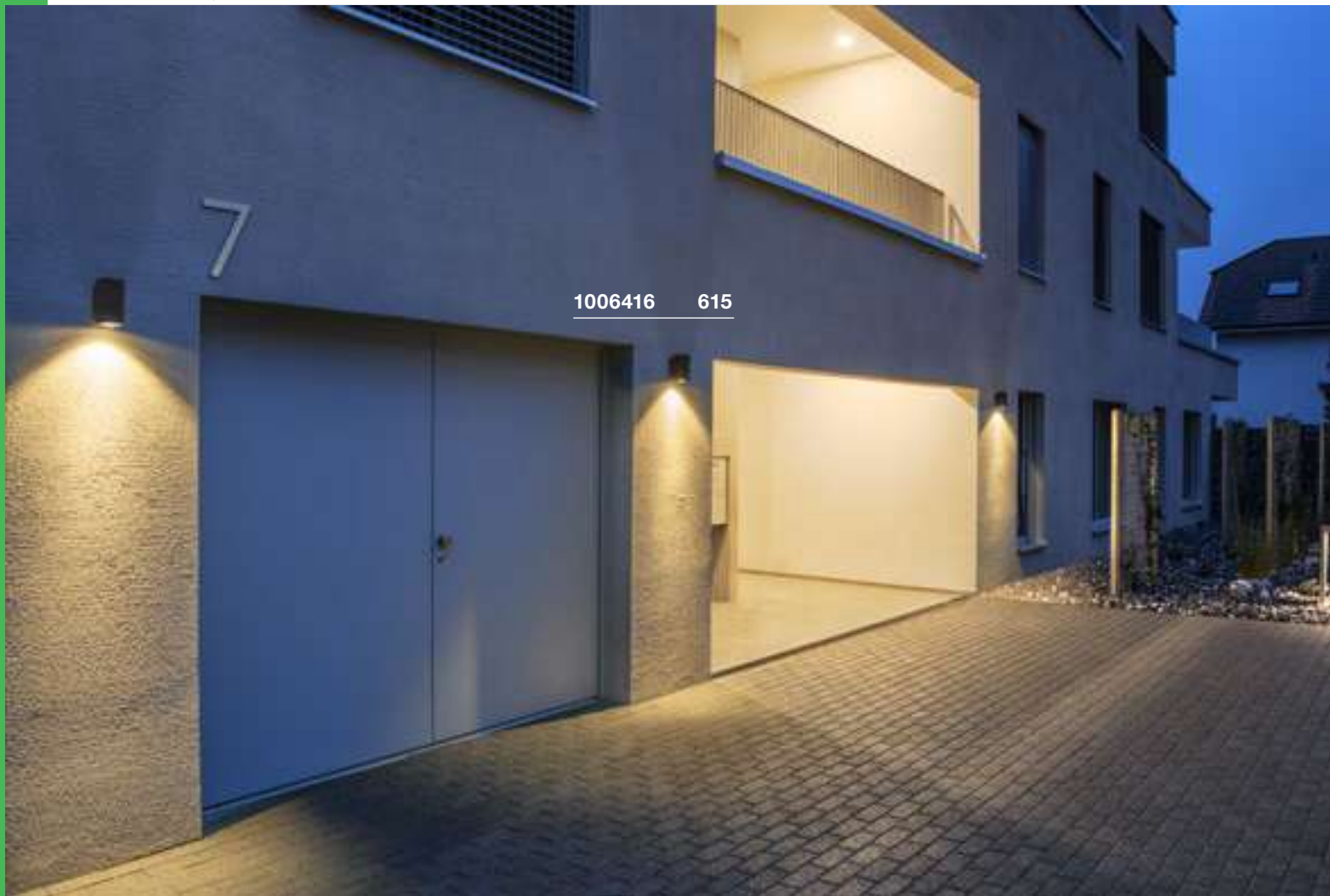

ENOLA SQUARE S
WL, single

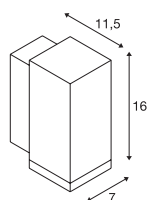
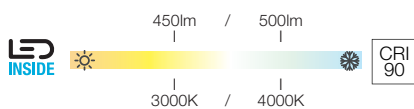

100-240V ~50/60Hz | 500mA
Systemleistung: 6W
Material: Aluminium / Glas

ENOLA SQUARE M
WL, single

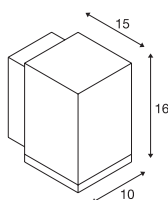
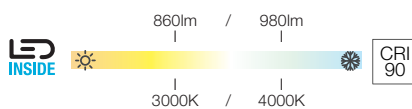

220-240V ~50/60Hz | 500mA
Systemleistung: 11W
Material: Aluminium / Glas

ENOLA SQUARE L
WL, single

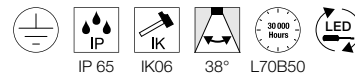
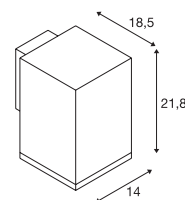
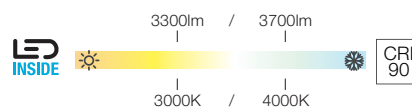

220-240V ~50/60Hz | 900mA
Systemleistung: 36W
Material: Aluminium / Glas



1003416	450/500lm 3000/4000K	



1003417	860/980lm 3000/4000K	



1003437	3300/3700lm 3000/4000K	



Abstandshalter Art. Nr. 1002853	
Reflektor 60° Art. Nr. 1005262	



Abstandshalter Art. Nr. 1002853	
Linse 19° Art. Nr. 1005205	
Linse asymmetrisch Art. Nr. 1005206	
Reflektor 60° Art. Nr. 1005207	



Abstandshalter Art. Nr. 1002853	
Reflektor 60° Art. Nr. 1005263	

Variante	Art. Nr.
450/500lm 3000/4000K CRI90	
anthrazit	1003416

Variante	Art. Nr.
860/980lm 3000/4000K CRI90	
anthrazit	1003417

Variante	Art. Nr.
3300/3700lm 3000/4000K CRI90	
anthrazit	1003437

ENOLA SQUARE S
UP/DOWN
WL

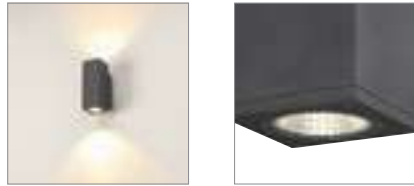

620lm / 700lm

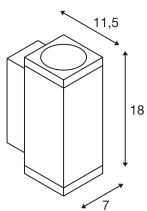

220-240V ~50/60Hz | 350mA
Systemleistung: 7.8W
Material: Aluminium / Glas

ENOLA SQUARE M
UP/DOWN
WL

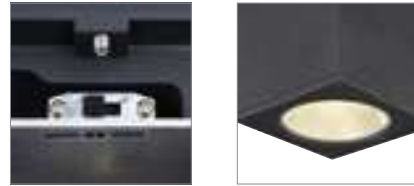

1660lm / 1900lm

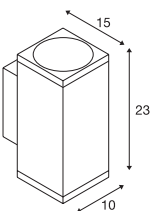

220-240V ~50/60Hz | 500mA
Systemleistung: 20W
Material: Aluminium / Glas

ENOLA SQUARE L
UP/DOWN
WL



5400lm / 6000lm

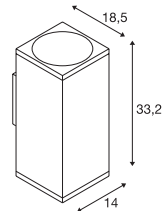

220-240V ~50/60Hz | 700mA
Systemleistung: 55W
Material: Aluminium / Glas

Up/Down	310/350lm 3000/4000K	
---------	-------------------------	--

Up/Down	830/950lm 3000/4000K	
---------	-------------------------	--

Up/Down	2700/3000lm 3000/4000K	
---------	---------------------------	--

-
- Abstandshalter
Art. Nr. 1002853
 - Reflektor 60°
Art. Nr. 1005262

-
- Abstandshalter
Art. Nr. 1002853
 - Linse 19°
Art. Nr. 1005205
 - Linse asymmetrisch
Art. Nr. 1005206
 - Reflektor 60°
Art. Nr. 1005207

-
- Abstandshalter
Art. Nr. 1002853
 - Reflektor 60°
Art. Nr. 1005263

Variante	Art. Nr.
Up: 310/350lm 3000/4000K CRI90 Down: 310/350lm CRI90	1003418
■ anthrazit	

Variante	Art. Nr.
Up: 830/950lm 3000/4000K CRI90 Down: 830/950lm 3000/4000K CRI90	1003419
■ anthrazit	

Variante	Art. Nr.
Up: 2700/3000lm 3000/4000K CRI90 Down: 2700/3000lm CRI90	1003438
■ anthrazit	



1003419 + 1005205 + 1005206 616 + 617

ENOLA S, M, L
Reflektor 56°

NEW



H: 1,85 cm Ø: 4,5 cm | S
H: 4 cm Ø: 7,5 cm | M
H: 6,96 cm Ø: 11 cm | L
Material: Polycarbonat (PC)



Variante	Art. Nr.
■ chrom S	1005262 ■
■ chrom M	1005207 ■
■ chrom L	1005263 ■

ENOLA M
Linse 19°

NEW



H: 3,8 cm
Ø: 7,5 cm
Material: Stahl / Polycarbonat (PC)



Variante	Art. Nr.
■ schwarz / chrom	1005205 ■

ENOLA M
Linse asymmetrisch

NEW



H: 3 cm
Ø: 7,5 cm
Material: Stahl / Polycarbonat (PC)



Variante	Art. Nr.
■ schwarz / chrom	1005206 ■



THEO UP/DOWN
WL, QPAR51



SOCKET INSIDE           <35 W

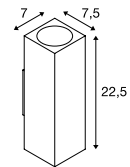

IP 44 IK02

220-240V ~50/60Hz
Material: Aluminium / Glas







GU10 <35W



LED GU10 51mm | 4W | 36°
2700K | 270lm | EEK=G
4kWh/1000h



Art. Nr. 1004972

Variante	Art. Nr.
2xGU10	
 anthrazit	229535
2xGU10	
 weiß	229531
2xGU10	
 grau	229532
2xGU10	
 aluminium	1000331



BIG THEO BEAM UP/
FLOOD DOWN
WL



BIG THEO UP/DOWN
WL, QPAR111



BIG THEO FLOOD
UP/DOWN
WL

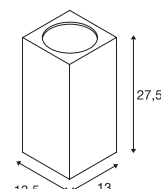
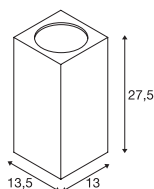
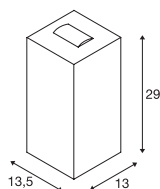
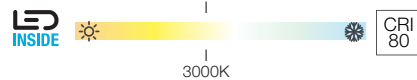
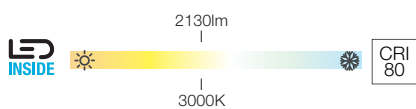

220-240V ~50/60Hz | 500mA
Systemleistung: 29W
Material: Aluminium / Glas

220-240V ~50/60Hz
Material: Aluminium / Glas

220-240V ~50/60Hz | 1000mA
Systemleistung: 42W
Material: Aluminium / Glas

		A → G
Down	2000lm 3000K	A → E
Beam	130lm 3000K	A → F

GU10 <75W

QPAR111 | 12,5W | 30°
2700K | 950lm | EEK=F
13kWh/1000h

Art. Nr. 1005276

		A → G
Up/Down	2000lm 3000K	A → E

Variante	Art. Nr.
Down: 2000lm 3000K CRI80 Beam: 130lm 3000K CRI80	
■ anthrazit	234515

Variante	Art. Nr.
2xGU10	
■ anthrazit	229575
2xGU10	
■ grau	229574

Variante	Art. Nr.
Up: 2000lm 3000K CRI80 Down: 2000lm 3000K CRI80	
■ anthrazit	234505

THEO
WL, QPAR51

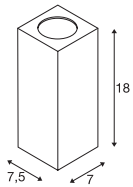

220-240V ~50/60Hz
Material: Aluminium / Glas



GU10 <35W



LED GU10 51mm | 4W | 36°
3000K | 280lm | EEK=F
4kWh/1000h



Art. Nr. 1004973

Variante	Art. Nr.
1xGU10	
■ anthrazit	229525
1xGU10	
■ grau	229524

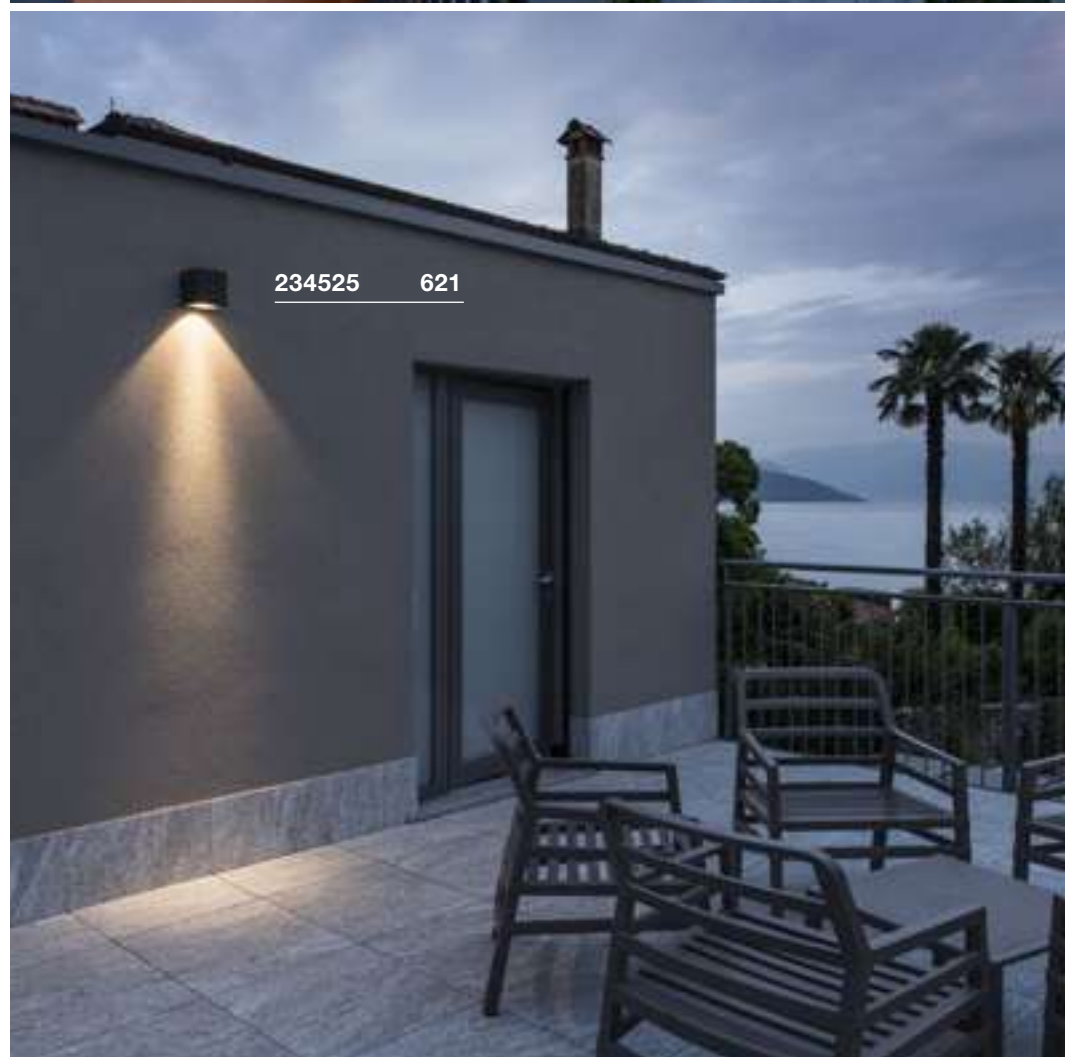



229564 621

BIG THEO
WL, QPAR111

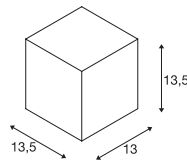
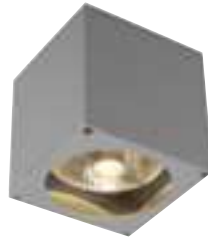

220-240V ~50/60Hz
Material: Aluminium / Glas



GU10 <75W



QPAR111 | 12,5W | 60°
2700K | 1040lm | EEK=F
13kWh/1000h



Art. Nr. 1005277

Variante	Art. Nr.
1xGU10	
■ anthrazit	229565
1xGU10	
■ grau	229564

BIG THEO
WL

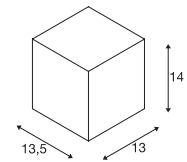
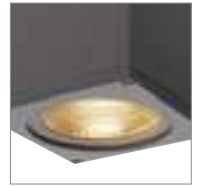

100-277V ~50/60Hz | 500mA
Systemleistung: 21W
Material: Aluminium / Glas



Art. Nr.	Systemleistung	Effizienz
234525	2000lm 3000K	A → G

Variante	Art. Nr.
2000lm 3000K CRI80	
■ anthrazit	234525

BIG QUAD
WL

SITRA CUBE
WL

SITRA CUBE
WL, TCR-TSE

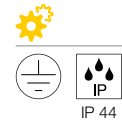
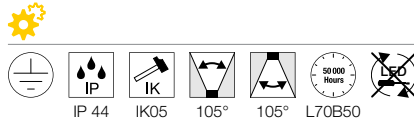
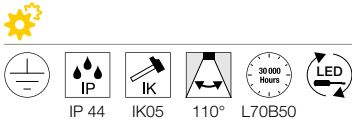
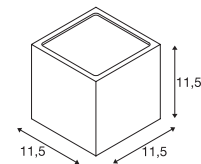
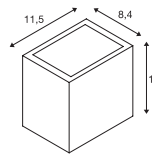
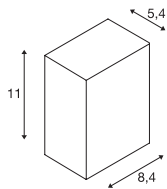
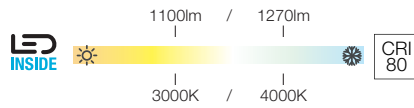
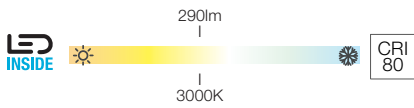
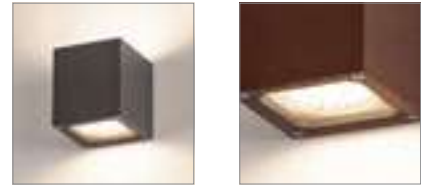
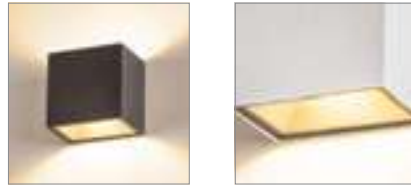
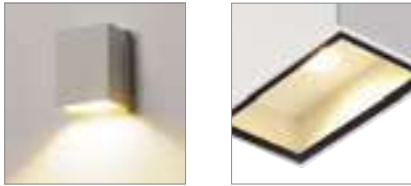

100-277V ~50/60Hz | 350mA
Systemleistung: 4.5W
Material: Aluminium / Glas

100-277V ~50/60Hz | 500mA
Systemleistung: 11W
Material: Aluminium / Glas

220-240V ~50/60Hz
Material: Aluminium / Glas

• Lichtfarbe durch Schalter im Gehäuse wählbar.

232431	290lm 3000K	

Up/Down	550/635lm 3000/4000K	

	GX53 <9W Ø: 7,5 cm L: 2,7 cm
	LED GX53 6W 120° 4000K 550lm EEK=F 6kWh/1000h
	Art. Nr. 1005269

Variante	Art. Nr.
290lm 3000K CRI80 □ weiß	232431

Variante	Art. Nr.
Up: 550/635lm 3000/4000K CRI80 Down: 550/635lm 3000/4000K CRI80	
■ anthrazit	1002032
Up: 550/635lm 3000/4000K CRI80 Down: 550/635lm 3000/4000K CRI80	
□ weiß	1002033
Up: 550/635lm 3000/4000K CRI80 Down: 550/635lm 3000/4000K CRI80	
■ rost	1002034

Variante	Art. Nr.
2xGX53 ■ anthrazit	232535
2xGX53 □ weiß	232531
2xGX53 ■ rost	232537



232537 623

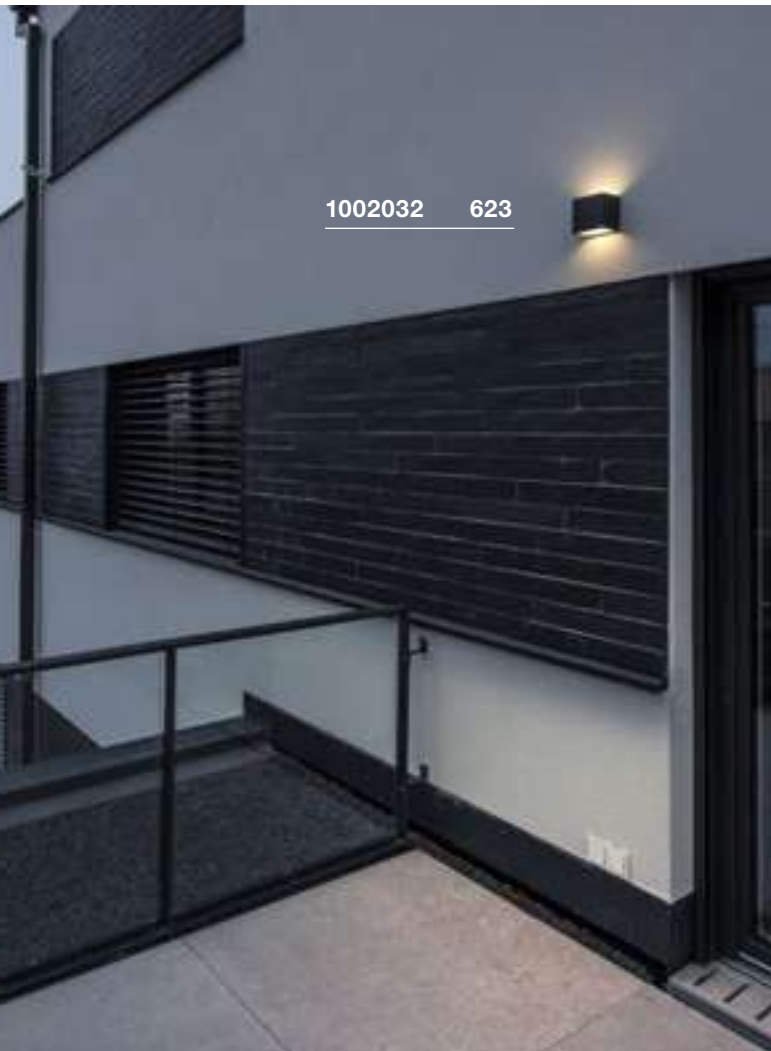

1002032 623



1002034 623

SITRA S
WL, single, eckig



NEW

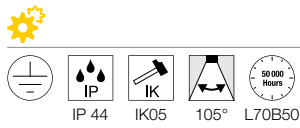
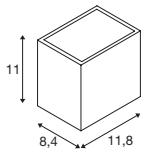
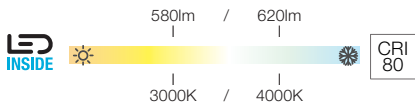
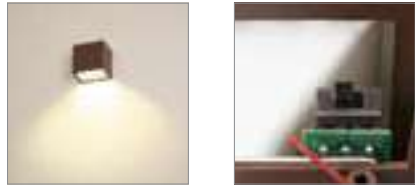

220-240V ~50/60Hz | 500mA
Systemleistung: 6,2W
Material: Aluminium / Glas

SITRA M
WL, up/down, eckig



NEW

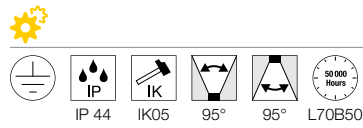
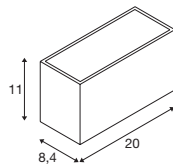
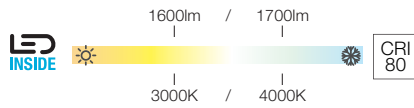
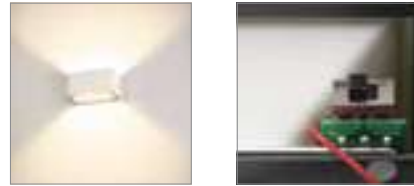

220-240V ~50/60Hz | 350mA
Systemleistung: 14W
Material: Aluminium / Glas

SITRA L
WL, up/down, eckig



NEW

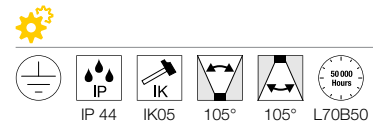
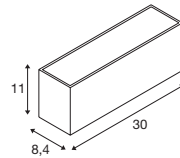
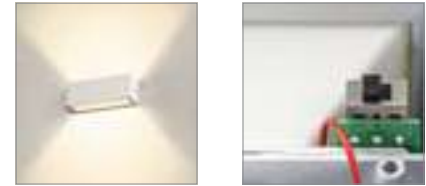

220-240V ~50/60Hz | 600mA
Systemleistung: 24W
Material: Aluminium / Glas

1005148, 1005149, 1005150	580/620lm 3000/4000K	

Variante	Art. Nr.
580/620lm 3000/4000K CRI80	
■ anthrazit	1005148
580/620lm 3000/4000K CRI80	
□ weiß	1005149
580/620lm 3000/4000K CRI80	
■ rost	1005150

Up/Down	800/850lm 3000/4000K	

Variante	Art. Nr.
Up: 800/850lm 3000/4000K CRI80 Down: 800/850lm 3000/4000K CRI80	
■ anthrazit	1005151
Up: 800/850lm 3000/4000K CRI80 Down: 800/850lm 3000/4000K CRI80	
□ weiß	1005153
Up: 800/850lm 3000/4000K CRI80 Down: 800/850lm 3000/4000K CRI80	
■ rost	1005154

Up/Down	1350/1400lm 3000/4000K	

Variante	Art. Nr.
Up: 1350/1400lm 3000/4000K CRI80 Down: 1350/1400lm 3000/4000K CRI80	
■ anthrazit	1005155
Up: 1350/1400lm 3000/4000K CRI80 Down: 1350/1400lm 3000/4000K CRI80	
□ weiß	1005156
Up: 1350/1400lm 3000/4000K CRI80 Down: 1350/1400lm 3000/4000K CRI80	
■ rost	1005157

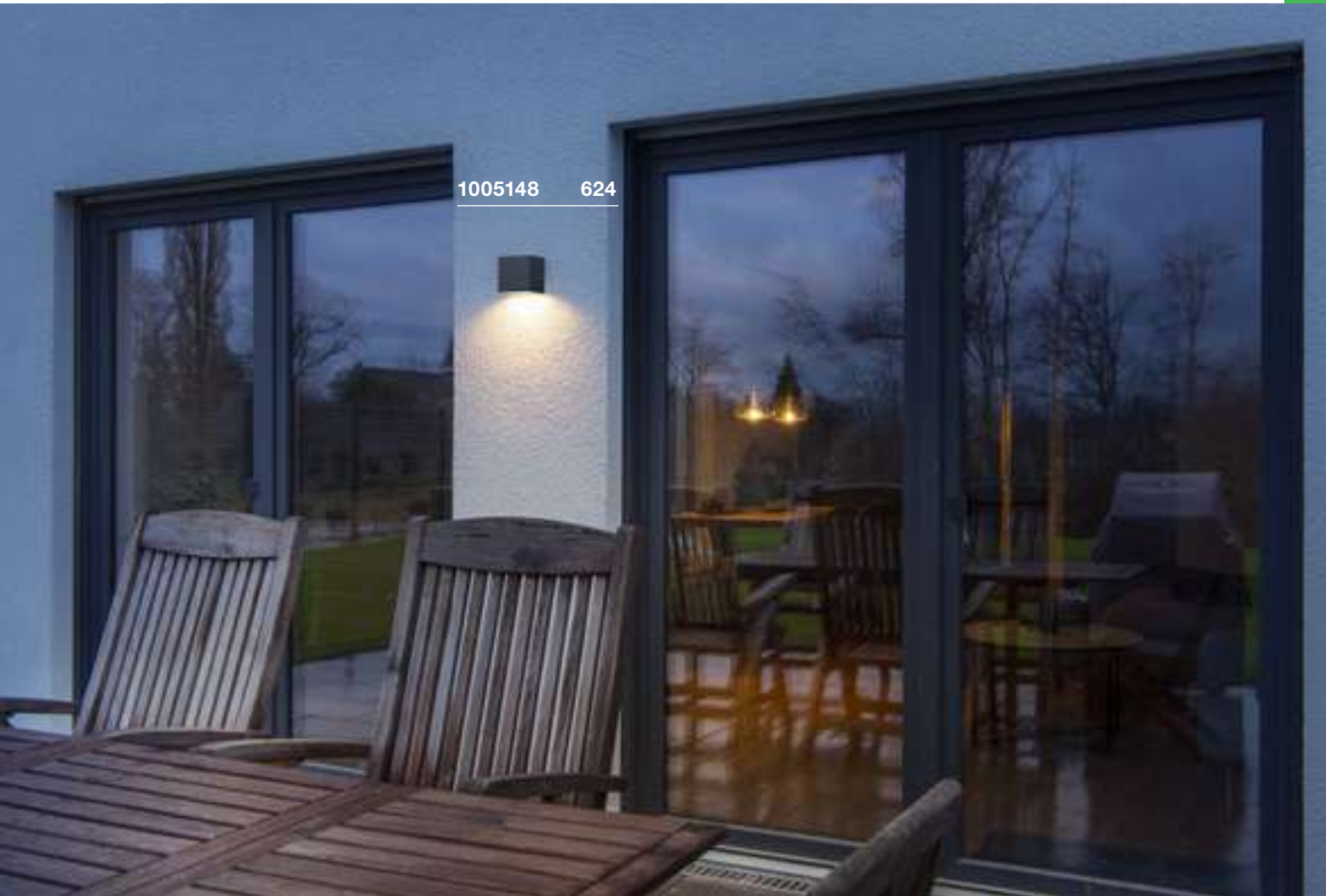

1005148 624



1005151 624

GRAFIT SENSOR
WL, rund, E27



GRAFIT
WL, rund, E27



NEW



NEW

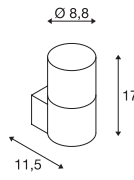
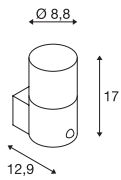

220-240V ~50/60Hz
Material: Aluminium / Acryl

220-240V ~50/60Hz
Material: Aluminium / Acryl



E27 <11W
Ø: 6 cm L: 11,5 cm



E27 <11W
Ø: 6 cm L: 11,5 cm



LED E27 | 9W | 220°
2700K | 800lm | EEK=F
9kWh/1000h



Art. Nr. 1005301



LED E27 | 7,5W | 320°
2700K | 800lm | EEK=F
8kWh/1000h



Art. Nr. 1005303

Variante	Art. Nr.
1xE27 ■ anthrazit	1006179 ■

Variante	Art. Nr.
1xE27 ■ anthrazit	1006178 ■





1006183 627

GRAFIT SENSOR
WL, eckig, E27



NEW



GRAFIT
WL, eckig, E27

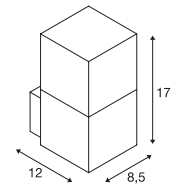
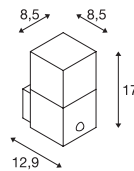

220-240V ~50/60Hz
Material: Aluminium / Acryl



220-240V ~50/60Hz
Material: Aluminium / Kunststoff



E27 <11W
Ø: 6 cm L: 11,5 cm



E27 <11W
Ø: 6 cm L: 11,5 cm



LED E27 | 13,2W | 220°
2700K | 1300lm | EEK=F
13kWh/1000h



Art. Nr. 1005302



LED E27 | 9W | 220°
2700K | 770lm | EEK=F
9kWh/1000h



Art. Nr. 1005301

Variante	Art. Nr.
1xE27	
■ anthrazit	1006183 ■

Variante	Art. Nr.
1xE27	
■ anthrazit	231205



1002402 629



1002403 629

QUADRULO
WL



NEW

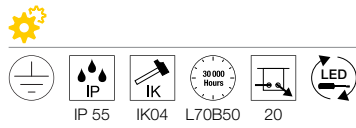
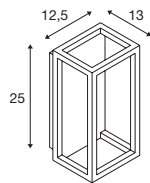
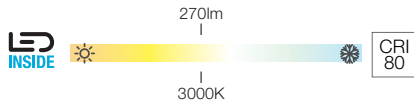

100-277V ~50/60Hz | 350mA
Systemleistung: 8W
Material: Aluminium / Acryl

1005201	270lm 3000K	

Variante	Art. Nr.
■ anthrazit	1005201

QUADRULO SENSOR
WL, E27

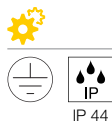
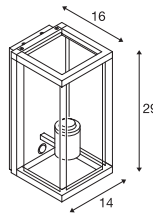

220-240V ~50/60Hz
Material: Aluminium / Glas

E27 <15W Ø: 8 cm L: 18 cm		
	LED E27 7,5W 320° 2500K 700lm EEK=F 8kWh/1000h	

Variante	Art. Nr.
1xE27 ■ anthrazit	1002402

QUADRULO
WL, E27

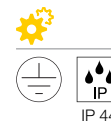
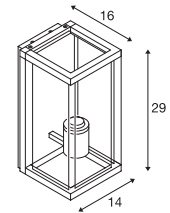
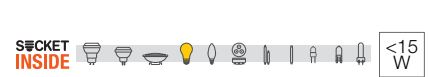

220-240V ~50/60Hz
Material: Aluminium / Glas

E27 <15W Ø: 8 cm L: 18 cm		
	LED E27 7,5W 320° 2500K 700lm EEK=F 8kWh/1000h	

Variante	Art. Nr.
1xE27 ■ anthrazit	1002403

MERIDIAN BOX SENSOR
WL, E27

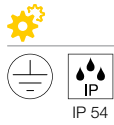
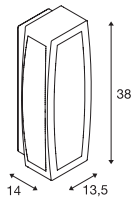

220-240V ~50/60Hz
Material: Aluminium / Polycarbonat (PC)

- Die Einschaltumgebungshelligkeit und Einschaltdauer können eingestellt werden.

E27 <25W
Ø: 7 cm L: 17,5 cm

LED E27 | 8W | 240°
3000K | 870lm | EEK=E
8kWh/1000h



Art. Nr. 1005289

Variante	Art. Nr.
1xE27	
■ anthrazit	230085
1xE27	
■ grau	230084

MERIDIAN BOX
WL, E27

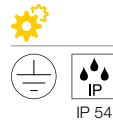
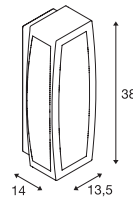

220-240V ~50/60Hz
Material: Aluminium / Polycarbonat (PC)

E27 <25W
Ø: 7 cm L: 17,5 cm

LED E27 | 7,5W | 320°
2500K | 700lm | EEK=F
8kWh/1000h



Art. Nr. 1005265

Variante	Art. Nr.
1xE27	
■ anthrazit	230655
1xE27	
■ rost	230657

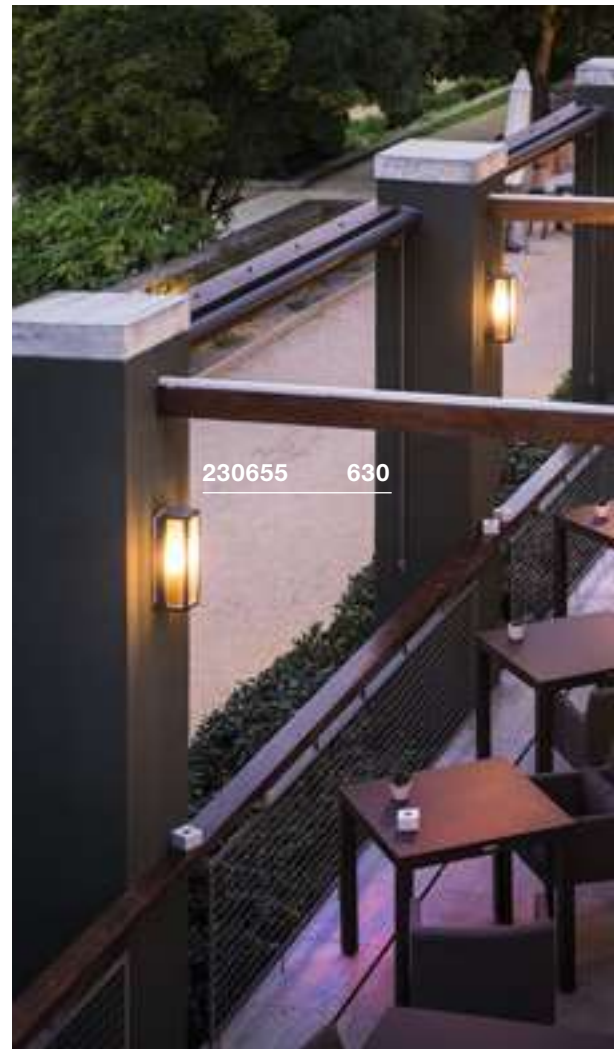



1004748 631

ESKINA FRAME WL



ESKINA FRAME WL, double

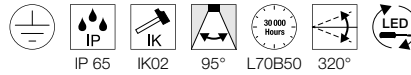
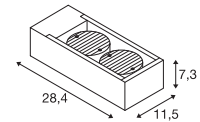
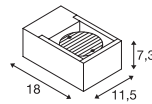
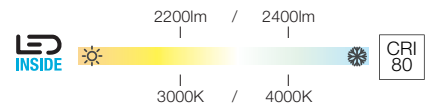
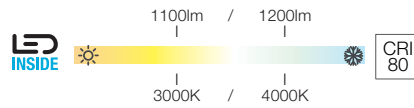
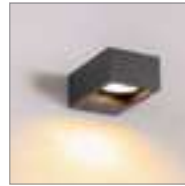
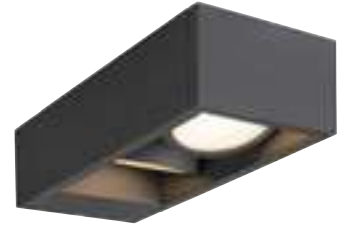
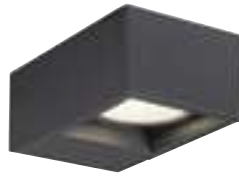

220-240V ~50/60Hz | 350mA
Systemleistung: 15W
Material: Aluminium

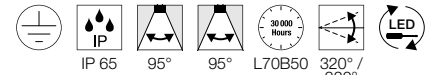

220-240V ~50/60Hz | 700mA
Systemleistung: 27W
Material: Aluminium



1004748 631



1004747	1100/1200lm 3000/4000K	

Variante Art. Nr.
1100/1200lm | 3000/4000K | CRI80
■ anthrazit **1004747**



Spot1/Spot2	1100/1200lm 3000/4000K	

Variante Art. Nr.
Spot 1: 1100/1200lm | 3000/4000K | CRI80
Spot 2: 1100/1200lm | 3000/4000K | CRI80
■ anthrazit **1004748**

BOOKAT
WL



NEW

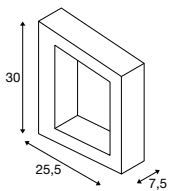
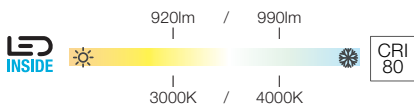
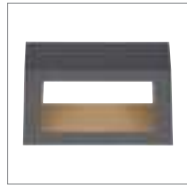
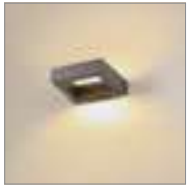
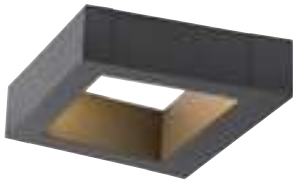

IP 65
 IK05
 L70B50
 30000 Hours
 20
 LED

100-277V ~50/60Hz | 700mA
 Systemleistung: 15W
 Material: Aluminium



1005443	920/990lm 3000/4000K	

Variante	Art. Nr.
920/990lm 3000/4000K CRI80	
■ anthrazit	1005443 ■



1005443 632



232435 633

BIG QUAD WL

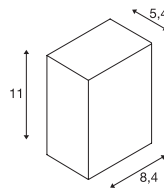
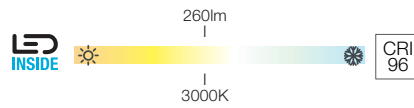
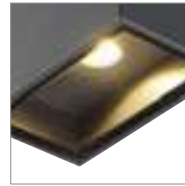

100-277V ~50/60Hz | 350mA
 Systemleistung: 4,5W
 Material: Aluminium / Glas



232435	260lm 3000K	

Variante	Art. Nr.
260lm 3000K CRI96 ■ anthrazit	232435

QUAD WL

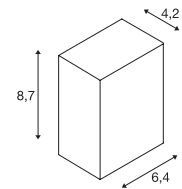
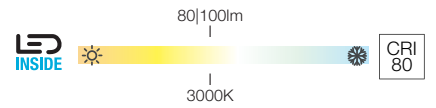
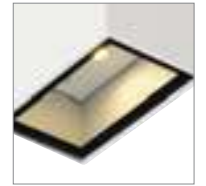

200-240V ~50/60Hz | 700mA
 Systemleistung: 4,6W
 Material: Aluminium / Glas



232465, 232461	80lm 100lm 3000K	

Variante	Art. Nr.
80lm 3000K CRI80 ■ anthrazit	232465
100lm 3000K CRI80 □ weiß	232461



232465 633

QUAD UP/DOWN 12
WL

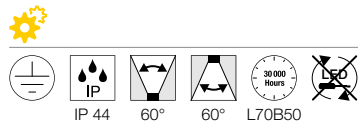
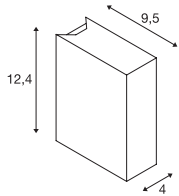
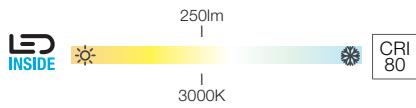

100-277V ~50/60Hz | 700mA
Systemleistung: 6.4W
Material: Aluminium / Glas

QUAD UP/DOWN 15
WL

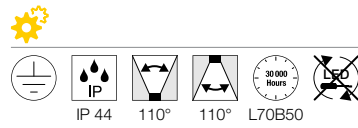
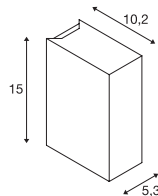
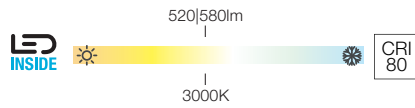
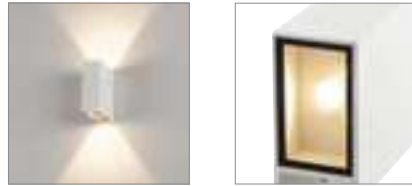

100-277V ~50/60Hz | 350mA
Systemleistung: 8W
Material: Aluminium / Glas



232471 634

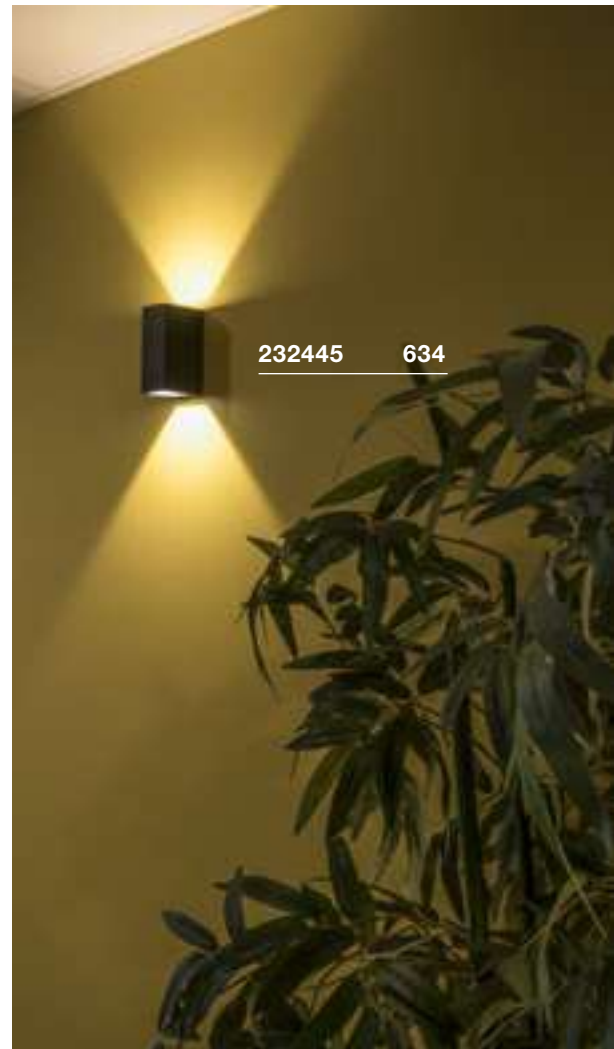

232445 634



Up/Down	125lm 3000K	

Variante	Art. Nr.
Up: 125lm 3000K CRI80 Down: 125lm 3000K CRI80	
■ anthrazit	232475
Up: 125lm 3000K CRI80 Down: 125lm 3000K CRI80	
□ weiß	232471



Up/Down	260lm 290lm 3000K	

Variante	Art. Nr.
Up: 260lm 3000K CRI80 Down: 260lm CRI80	
■ anthrazit	232445
Up: 290lm 3000K CRI80 Down: 290lm 3000K CRI80	
□ weiß	232441



1005126 635

BIG QUAD UP/DOWN WL



640lm

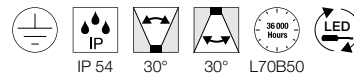
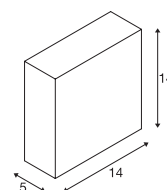
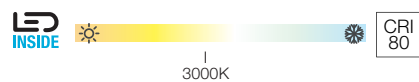

200-240V ~50/60Hz | 350mA
 Systemleistung: 8,2W
 Material: Aluminium / Glas



Up/Down	320lm 3000K	

Variante	Art. Nr.
Up: 320lm 3000K CRI80 Down: 320lm 3000K CRI80	
anthrazit	1005126
Up: 320lm 3000K CRI80 Down: 320lm 3000K CRI80	
weiß	1005125

RUSTY® UP/DOWN
WL, quadratisch



RUSTY® UP/DOWN
WL, rund

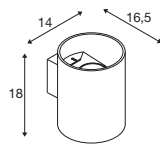
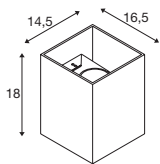
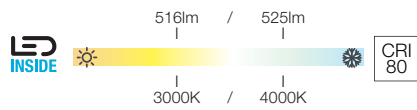
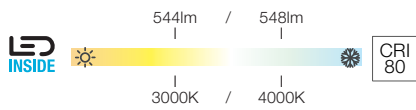

IP 65 IK02 65° 65° L70B50

IP 65 IK02 65° 65° L70B50

220-240V ~50/60Hz | 350mA
Systemleistung: 14W
Material: FeCSi-Stahl / Aluminium

220-240V ~50/60Hz | 350mA
Systemleistung: 14W
Material: FeCSi-Stahl / Aluminium

Up	259/260lm 3000/4000K	
Down	285/288lm 3000/4000K	

Up	249/254lm 3000/4000K	
Down	267/271lm 3000/4000K	

Variante Art. Nr.
Up: 259/260lm | 3000/4000K | CRI80
Down: 285/288lm | 3000/4000K | CRI80
■ rost **1004650**

Variante Art. Nr.
Up: 249/254lm | 3000/4000K | CRI80
Down: 267/271lm | 3000/4000K | CRI80
■ rost **1004651**

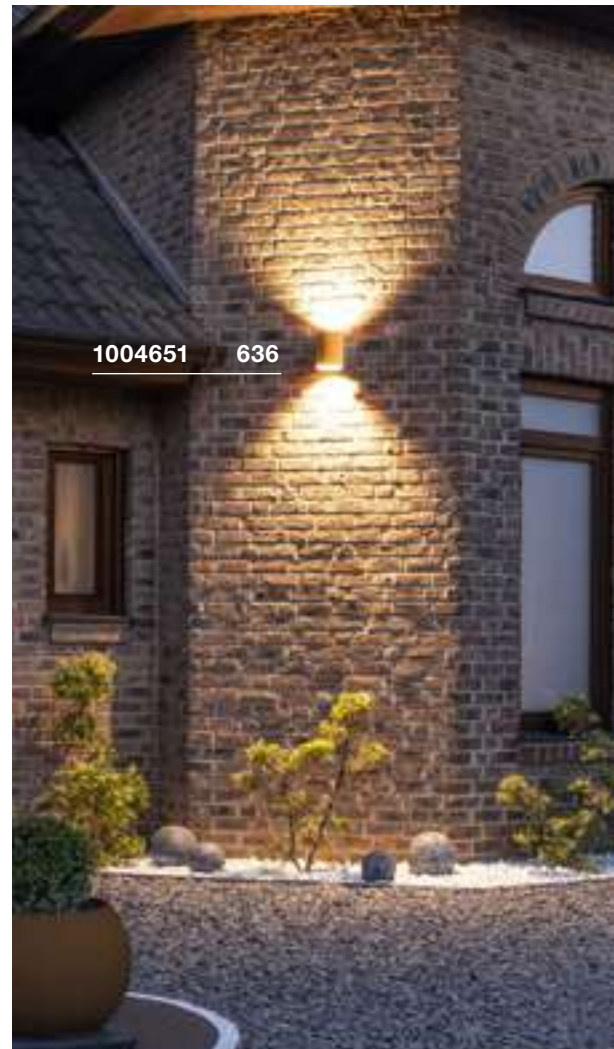
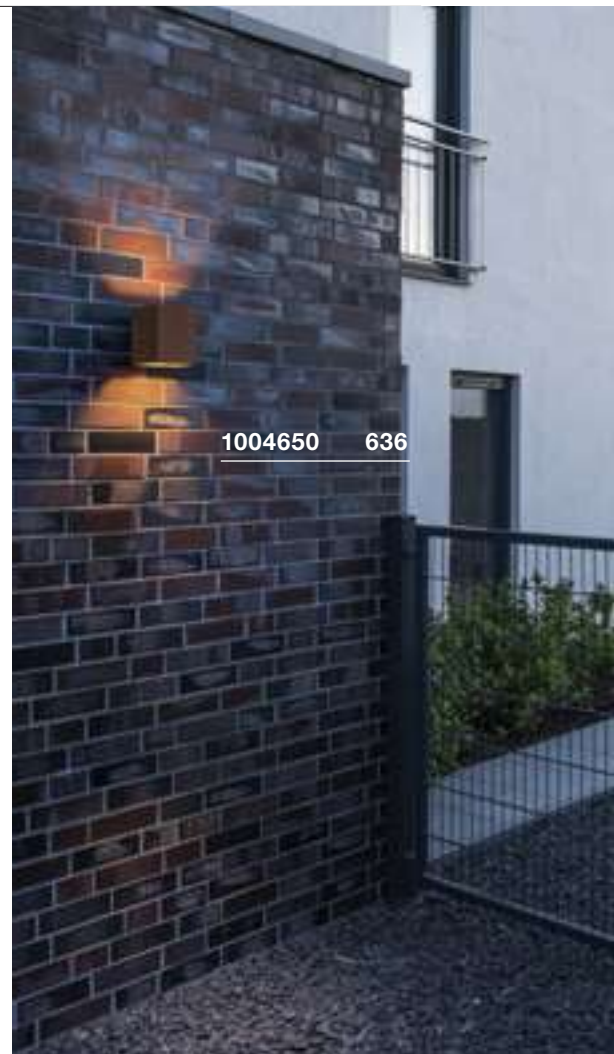



1004679 637

OVALISK SENSOR
WL

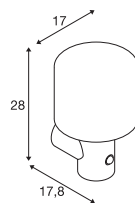
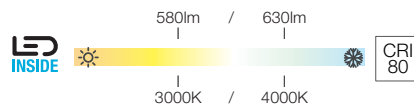

220-240V ~50/60Hz | 500mA
Systemleistung: 9.6W
Material: Aluminium / Glas

OVALISK
WL

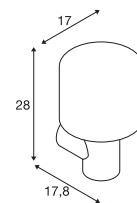
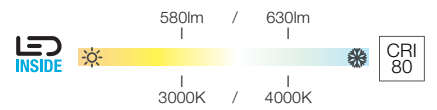

220-240V ~50/60Hz | 500mA
Systemleistung: 9.2W
Material: Aluminium / Glas



1004679	580/630lm 3000/4000K	

Variante **Art. Nr.**
580/630lm | 3000/4000K | CRI80
■ anthrazit **1004679**



1004678	580/630lm 3000/4000K	

Variante **Art. Nr.**
580/630lm | 3000/4000K | CRI80
■ anthrazit **1004678**

PEMA®
WL

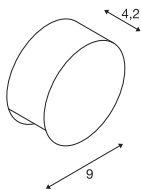
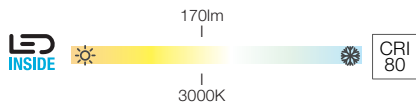
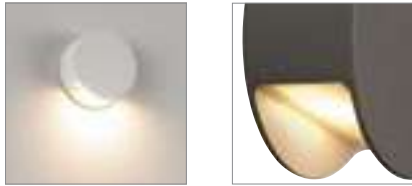

220-240V ~50/60Hz
Systemleistung: 3,8W
Material: Aluminium / Glas

- Schutzart IP44 nur bei Montage mit Lichtaustritt nach unten.



231015, 231010, 231012	170lm 3000K	

Variante	Art. Nr.
170lm 3000K CRI80	
■ anthrazit	231015
170lm 3000K CRI80	
□ weiß	231010
170lm 3000K CRI80	
■ grau	231012

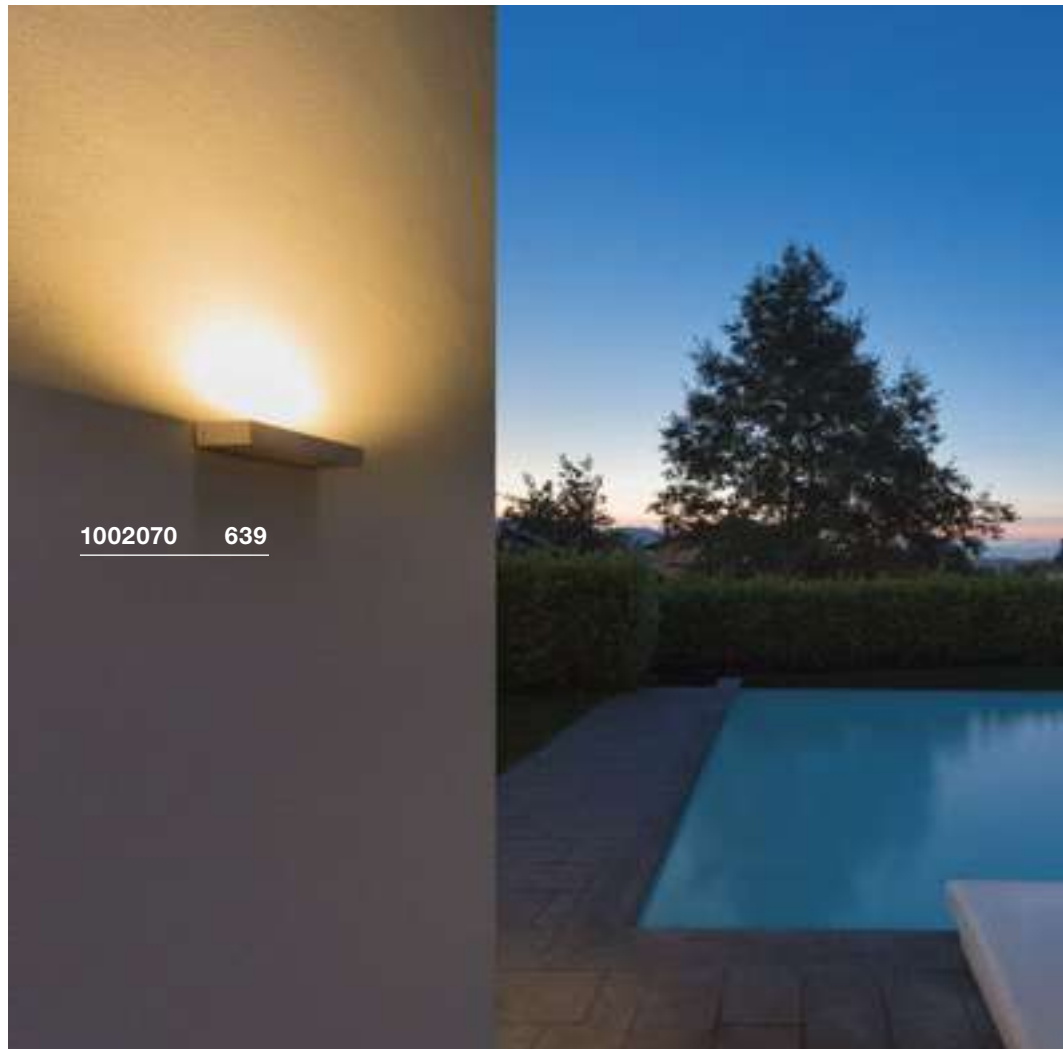

PEMA®
WL

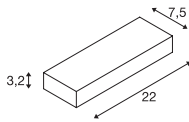
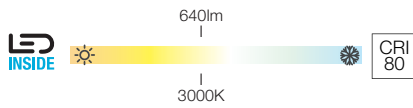
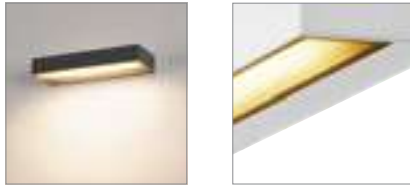
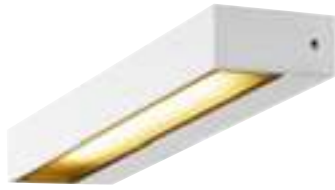

220-240V ~50/60Hz
Systemleistung: 7.7W
Material: Aluminium / Glas

- Schutzart IP54 nur bei Montage mit Lichtaustritt nach unten.

1002069, 1002070	640lm 3000K	

Variante	Art. Nr.
640lm 3000K CRI80 ■ anthrazit	1002069
640lm 3000K CRI80 □ weiß	1002070

PEMA®
WL

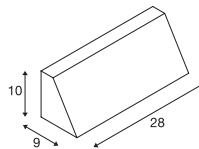
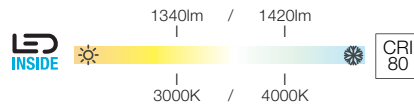

100-277V ~50/60Hz | 350mA
Systemleistung: 14W
Material: Aluminium / Glas

1003453, 1003454	1340/1420lm 3000/4000K	

Variante	Art. Nr.
1340/1420lm 3000/4000K CRI80 ■ schwarz	1003453
1340/1420lm 3000/4000K CRI80 ■ grau	1003454

PEMA®
WL, E27

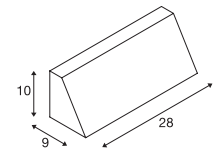

220-240V ~50/60Hz
Material: Aluminium / Glas

E27 <15W Ø: 4,5 cm L: 21 cm		

LED E27 | 8W | 240°
 3000K | 870lm | EEK=E
 8kWh/1000h

Art. Nr. **1005289**

Variante	Art. Nr.
1xE27 ■ schwarz	230030
1xE27 ■ grau	230034

FLATT SENSOR
WL

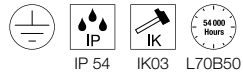
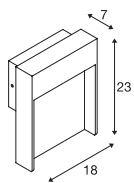
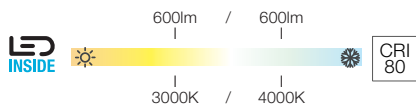

100-277V ~50/60Hz | 500mA
Systemleistung: 16W
Material: Aluminium

FLATT
WL

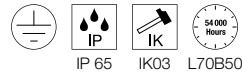
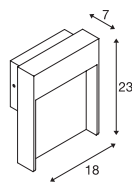
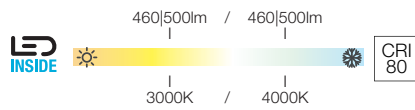

100-277V ~50/60Hz | 300mA
Systemleistung: 14W
Material: Aluminium

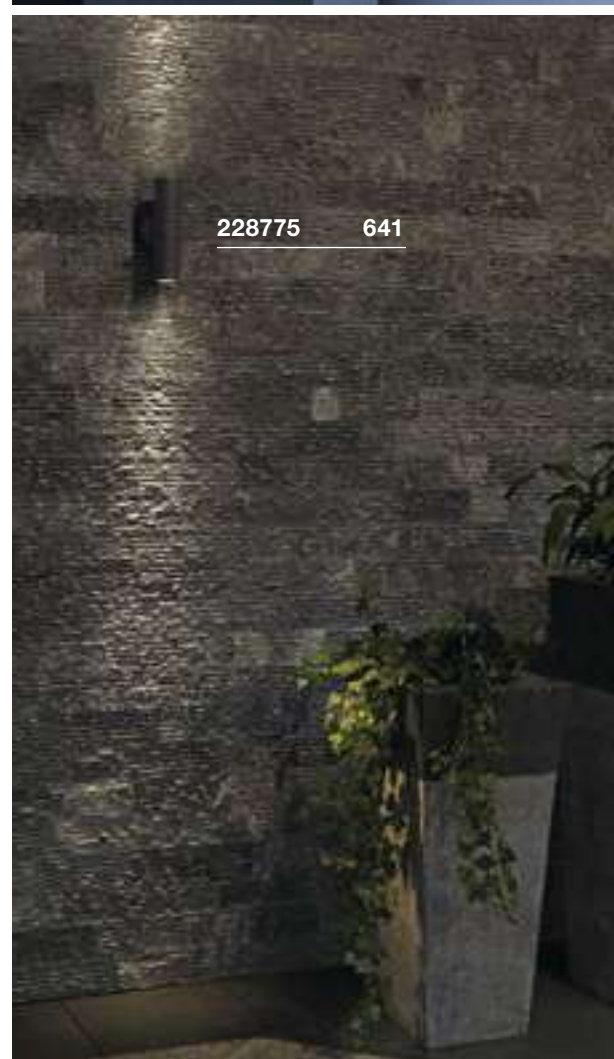

1002954, 1002955	600lm 3000/4000K	

Variante	Art. Nr.
600lm 3000/4000K CRI80	
■ anthrazit	1002954
600lm 3000/4000K CRI80	
■ anthrazit / braun	1002955



1002952, 1002953	460lm 500lm 3000/4000K	

Variante	Art. Nr.
460lm 3000/4000K CRI80	
■ anthrazit	1002952
500lm 3000/4000K CRI80	
■ anthrazit / braun	1002953



ASTINA
WL, QPAR51

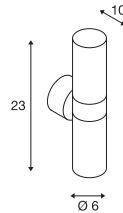

220-240V ~50/60Hz
Material: Aluminium / Glas

ASTINA STEEL
WL, QPAR51

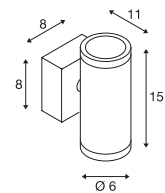
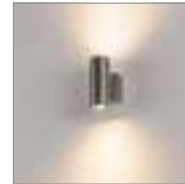

220-240V ~50/60Hz
Material: Edelstahl 304

233302 641



GU10 <11W
L: 9 cm



LED GU10 51mm | 4W | 36°
2700K | 270lm | EEK=G
4kWh/1000h

Art. Nr. 1004972



GU10 <35W
Ø: 5,1 cm L: 5,7 cm



LED GU10 51mm | 4W | 36°
3000K | 270lm | EEK=G
4kWh/1000h

Art. Nr. 1004973

Variante	Art. Nr.
2xGU10	
■ anthrazit	228775
2xGU10	
□ weiß	228771
2xGU10	
□ aluminium	228776

Variante	Art. Nr.
2xGU10	
■ edelstahl	233302

ANGOLUX SENSOR
WL

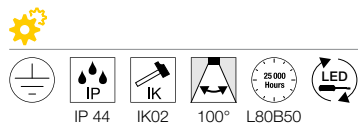
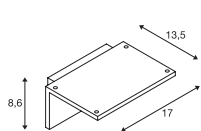
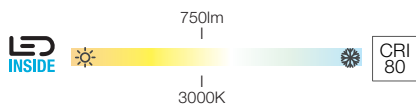

100-240V ~50/60Hz | 240mA
Systemleistung: 9.8W
Material: Aluminium / Kunststoff

- Erfassungswinkel 120°. max. Erfassungs-distanz 9m. Ansprechempfindlichkeit und Einschaltdauer einstellbar
- Schutzart IP44 nur bei Montage mit Lichtaustritt nach unten

ANGOLUX
WL

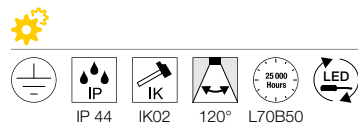
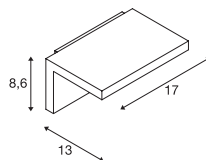
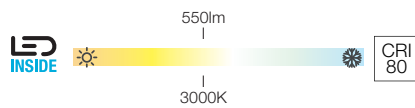
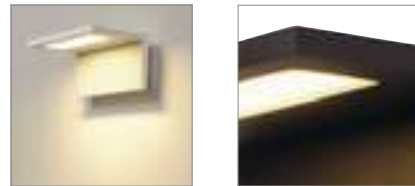

220-240V ~50/60Hz | 80mA
Systemleistung: 6.8W
Material: Aluminium / Kunststoff

- Schutzart IP44 nur bei Montage mit Lichtaustritt nach unten.

231355, 231351	550lm 3000K	

Variante	Art. Nr.
550lm 3000K CRI80	
■ anthrazit	231355
550lm 3000K CRI80	
□ weiß	231351

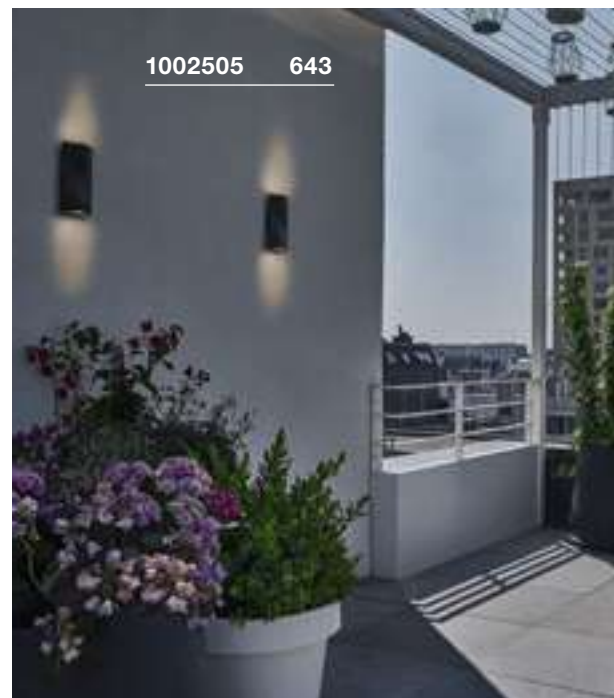
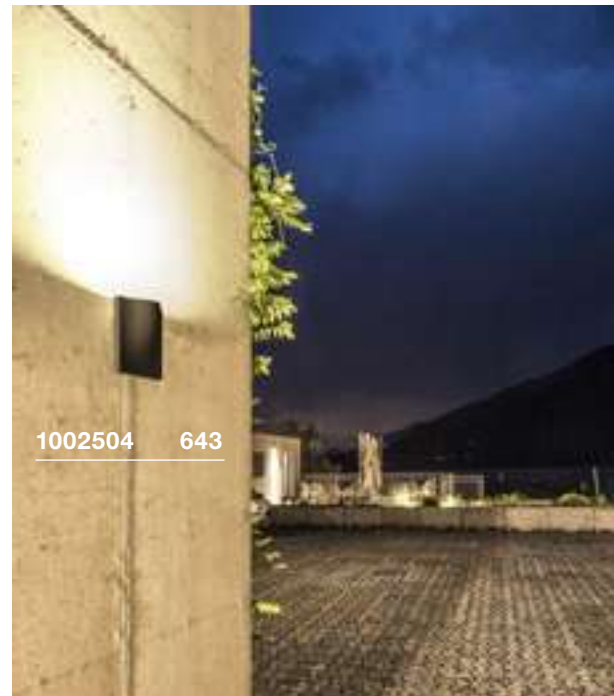
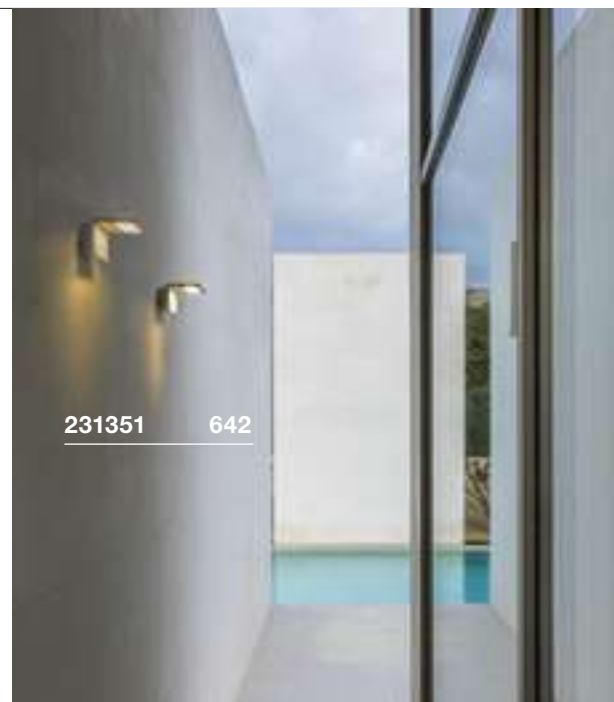

1001969, 1001970	750lm 3000K	

Variante	Art. Nr.
750lm 3000K CRI80	
■ anthrazit	1001969
750lm 3000K CRI80	
□ weiß	1001970

VILUA S
WL

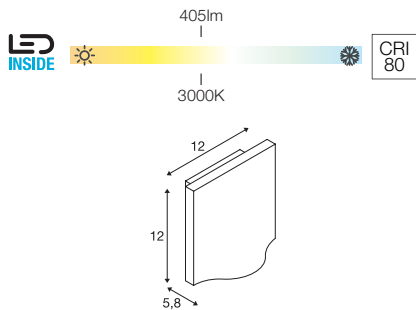

IP 54 IK02 100° L70B50

100-277V ~50/60Hz | 700mA
Systemleistung: 9W
Material: Aluminium / Glas

VILUA L
WL

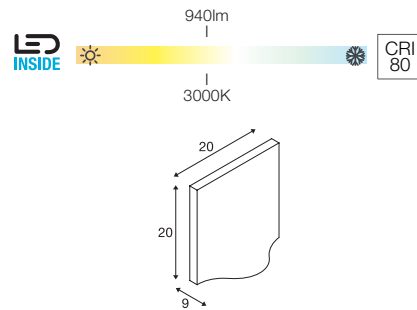

IP 54 IK02 100° L70B50

100-277V ~50/60Hz | 350mA
Systemleistung: 17W
Material: Aluminium / Glas

VILUA
UP/DOWN, WL

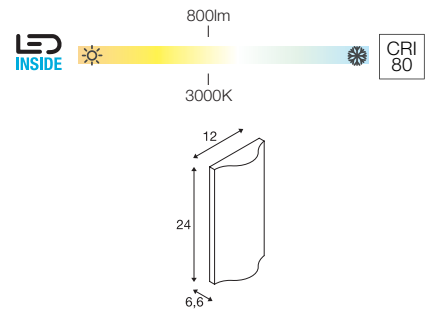

IP 54 IK02 100° 100° L70B50

100-277V ~50/60Hz | 700mA
Systemleistung: 16W
Material: Aluminium / Glas

1002503	405lm 3000K	

Variante Art. Nr.
405lm | 3000K | CRI80
■ anthrazit **1002503**

1002504	940lm 3000K	

Variante Art. Nr.
940lm | 3000K | CRI80
■ anthrazit **1002504**

Up/Down	400lm 3000K	

Variante Art. Nr.
Up: 400lm | 3000K | CRI80
Down: 400lm | 3000K | CRI80
■ anthrazit **1002505**

MYRA UP/DOWN
WL, QPAR51

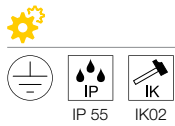
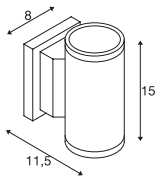
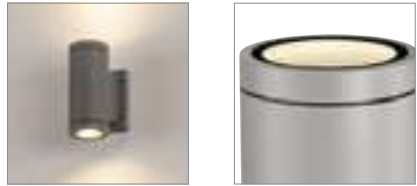

220-240V ~50/60Hz
Material: Aluminium / Glas

SITRA UP/DOWN
WL

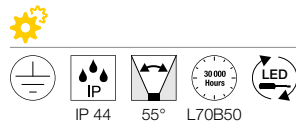
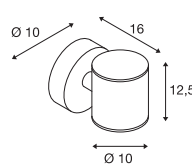
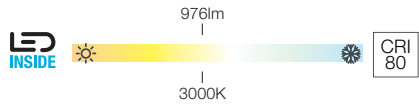

220-240V ~50/60Hz
Systemleistung: 18W
Material: Aluminium / Glas

SITRA UP/DOWN
WL, TCR-TSE

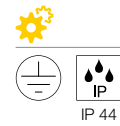
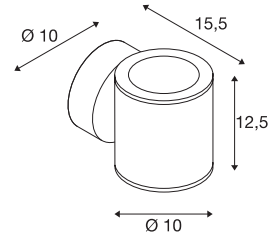

220-240V ~50/60Hz
Material: Aluminium / Glas

GU10 <35W
Ø: 5 cm L: 5,7 cm

LED GU10 51mm | 4W | 36°
2700K | 270lm | EEK=G
4kWh/1000h

Art. Nr. 1004972

Aufbaumontage Rahmen
Art. Nr. 233215

Variante	Art. Nr.
2xGU10	
■ anthrazit	233115
2xGU10	
■ grau	233114

Up/Down	488lm 3000K	A → G
		A G E

Variante	Art. Nr.
Up: 488lm 3000K CRI80	
Down: 488lm 3000K CRI80	
■ anthrazit	1002018

GX53 <9W
Ø: 7,5 cm L: 3,5 cm

LED GX53 | 6W | 120°
4000K | 550lm | EEK=F
6kWh/1000h

Art. Nr. 1005269

Variante	Art. Nr.
2xGX53	
■ anthrazit	230365



ROX
WL, QPAR111



ROX UP/DOWN
WL, QPAR111

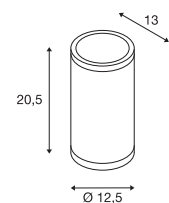
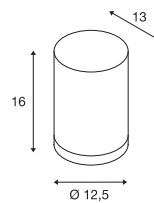
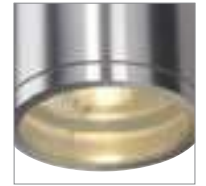
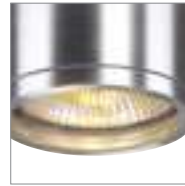

IP 44

220-240V ~50/60Hz
Material: Aluminium / Glas



IP 44

220-240V ~50/60Hz
Material: Aluminium / Glas



GU10 <50W



GU10 <50W



QPAR111 | 12,5W | 10°
2700K | 920lm | EEK=F
13kWh/1000h



Art. Nr. 1005275



QPAR111 | 12,5W | 30°
2700K | 950lm | EEK=F
13kWh/1000h



Art. Nr. 1005276

Variante	Art. Nr.
1xGU10	
aluminium	1000333

Variante	Art. Nr.
2xGU10	
aluminium	1000334



1000340 647



227195 647

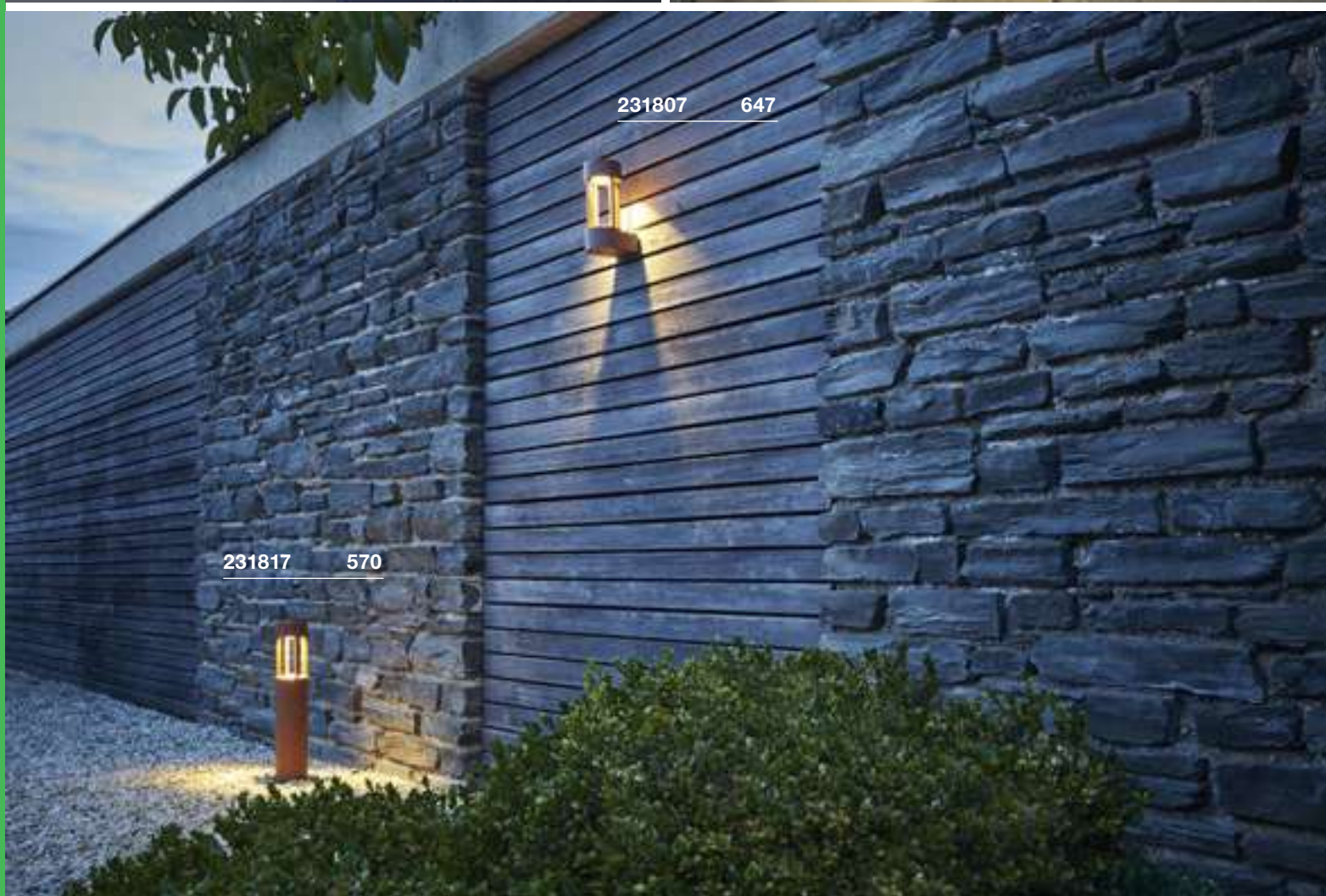

231807 647

231817 570

DELWA
WL

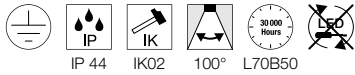
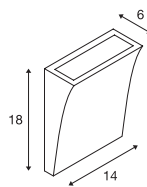
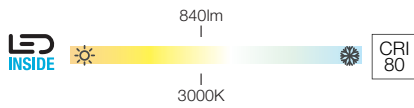
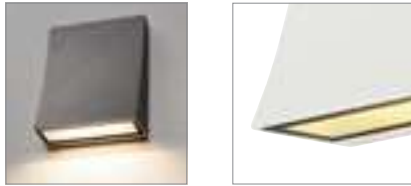

220-240V ~50/60Hz | 700mA
Systemleistung: 10W
Material: Aluminium / Glas

SLOTS
WL

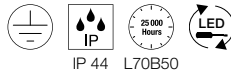
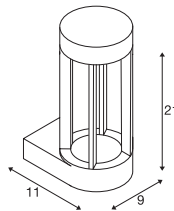
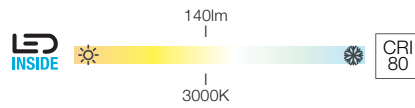

220-240V ~50/60Hz
Systemleistung: 4.5W
Material: Aluminium / Glas

WALLYX
WL, QPAR51

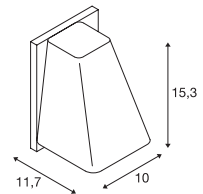
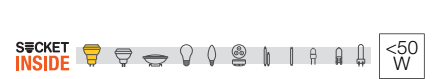
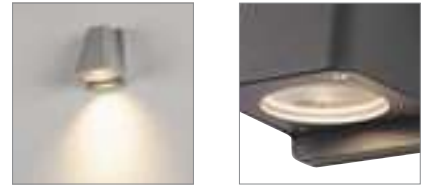

220-240V ~50/60Hz
Material: Aluminium / Glas



1000342, 1000340	840lm 3000K	



231805, 231807	140lm 3000K	



	GU10 <50W L: 7,6 cm
	LED GU10 51mm 4W 36° 2700K 270lm EEK=G 4kWh/1000h

Art. Nr. 1004972

Variante	Art. Nr.
840lm 3000K CRI80	
■ anthrazit	1000342
840lm 3000K CRI80	
□ weiß	1000340

Variante	Art. Nr.
140lm 3000K CRI80	
■ anthrazit	231805
140lm 3000K CRI80	
■ rost	231807

Variante	Art. Nr.
1xGU10	
■ anthrazit	227195
1xGU10	
■ grau	227194

DOWNUNDER OUT
WL, rund

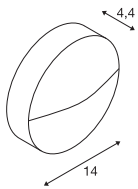
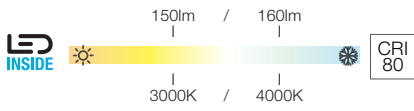

IP 65 L70B50

100-240V ~50/60Hz | 500mA
Systemleistung: 4.3W
Material: Aluminium

DOWNUNDER OUT
WL, quadratisch

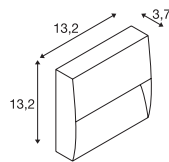

IP 65 L70B50

100-240V ~50/60Hz | 500mA
Systemleistung: 4.3W
Material: Aluminium

1002868	150/160lm 3000/4000K	

Variante	Art. Nr.
150/160lm 3000/4000K CRI80	
■ anthrazit	1002868

1002869	150/160lm 3000/4000K	

Variante	Art. Nr.
150/160lm 3000/4000K CRI80	
■ anthrazit	1002869

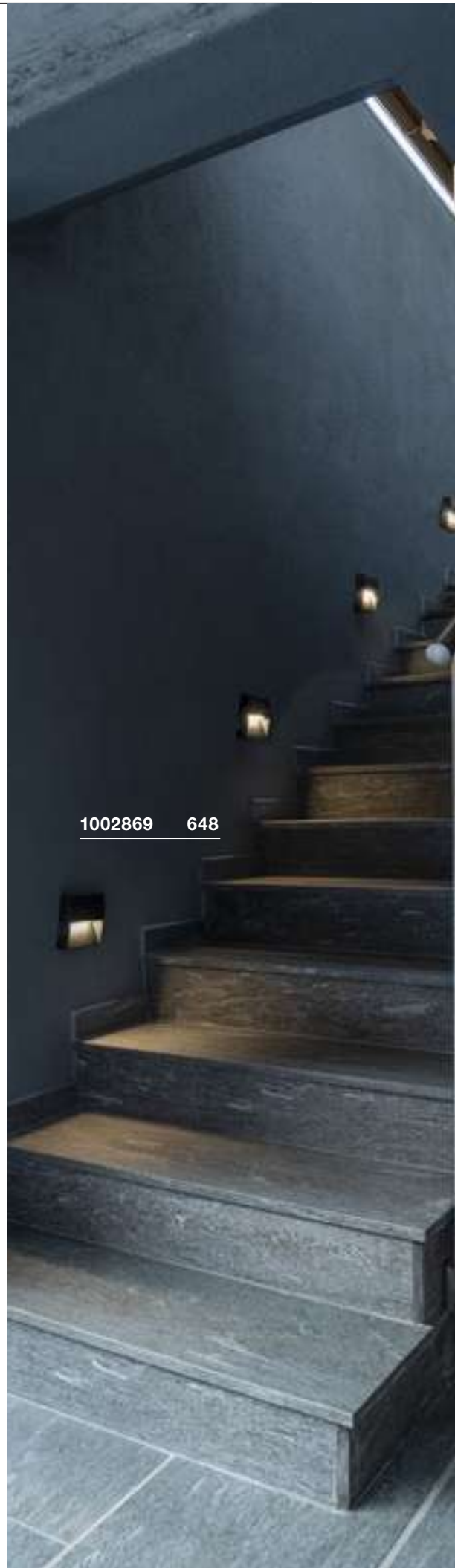

1002869 648



1002868 648

ABRIDOR SENSOR
WL

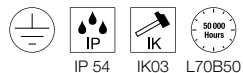
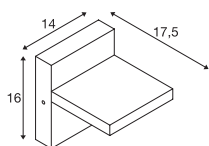
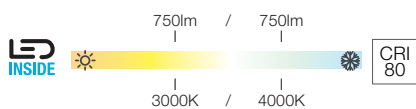

100-277V ~50/60Hz | 500mA
Systemleistung: 14W
Material: Aluminium

ABRIDOR
WL

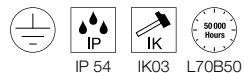
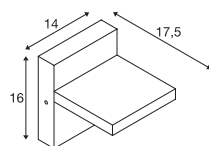
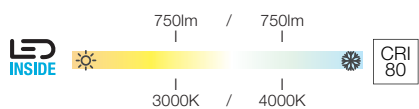

100-277V ~50/60Hz | 500mA
Systemleistung: 14W
Material: Aluminium

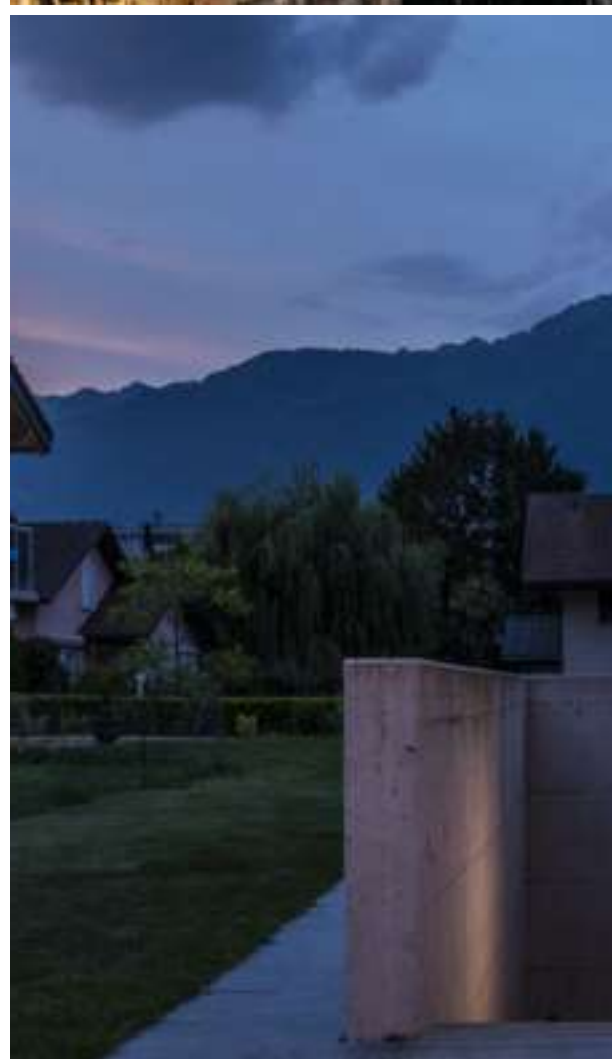

1002990, 1002989	750lm 3000/4000K	



1002990, 1002989	750lm 3000/4000K	

Variante **Art. Nr.**
750lm | 3000/4000K | CRI80
■ anthrazit **1002990**

Variante **Art. Nr.**
750lm | 3000/4000K | CRI90
■ anthrazit **1002989**



232915 651

ORDI SENSOR
WL

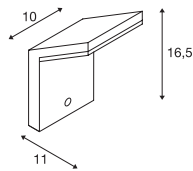

220-240V ~50/60Hz | 110mA
Systemleistung: 9W
Material: Aluminium

ORDI
WL

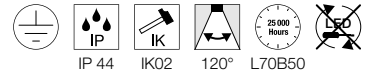
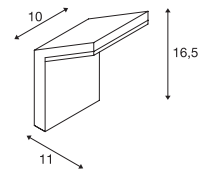
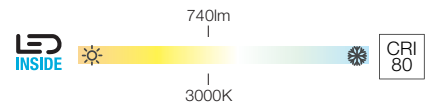

220-240V ~50/60Hz | 110mA
Systemleistung: 9W
Material: Aluminium



232915, 232905	740lm 3000K	

Variante	Art. Nr.
740lm 3000K CRI80 ■ anthrazit	232915



232915, 232905	740lm 3000K	

Variante	Art. Nr.
740lm 3000K CRI80 ■ anthrazit	232905

BOX-L
WL, E27

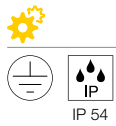
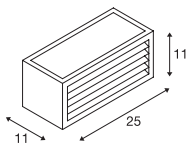

220-240V ~50/60Hz
Material: Aluminium / Acryl

E27 <18W
Ø: 6 cm L: 17,5 cm

LED E27 | 8W | 240°
3000K | 870lm | EEK=E
8kWh/1000h

Art. Nr. 1005289

BOX UP/DOWN
WL, QT-DE12

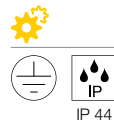
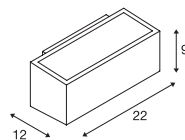

220-240V ~50/60Hz
Material: Aluminium / Glas

R7s 78mm <80W

LED R7s | 9W | 330°
3000K | 980lm | EEK=E
9kWh/1000h

Art. Nr. 1005287

Variante	Art. Nr.
1xR7s 78mm	
■ anthrazit	232485

LOGS
WL

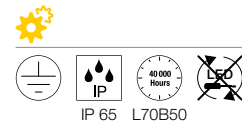
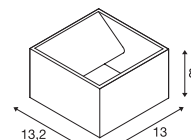
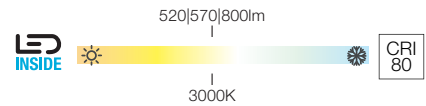
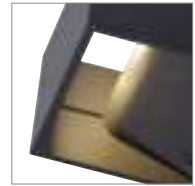
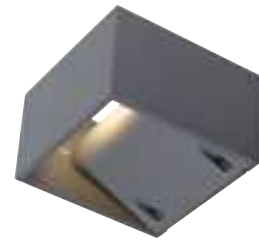

220-240V ~50/60Hz | 500mA
Systemleistung: 9.5W
Material: Aluminium

Art. Nr.	Light Output	Energy Efficiency
232105, 232101, 232104	520lm 800lm 570lm 3000K	A → G

Variante	Art. Nr.
520lm 3000K CRI80	
■ anthrazit	232105
800lm 3000K CRI80	
□ weiß	232101
570lm 3000K CRI80	
■ silber	232104

Variante	Art. Nr.
1xE27	
■ anthrazit	232495
1xE27	
□ weiß	232491
1xE27	
■ rost	232497

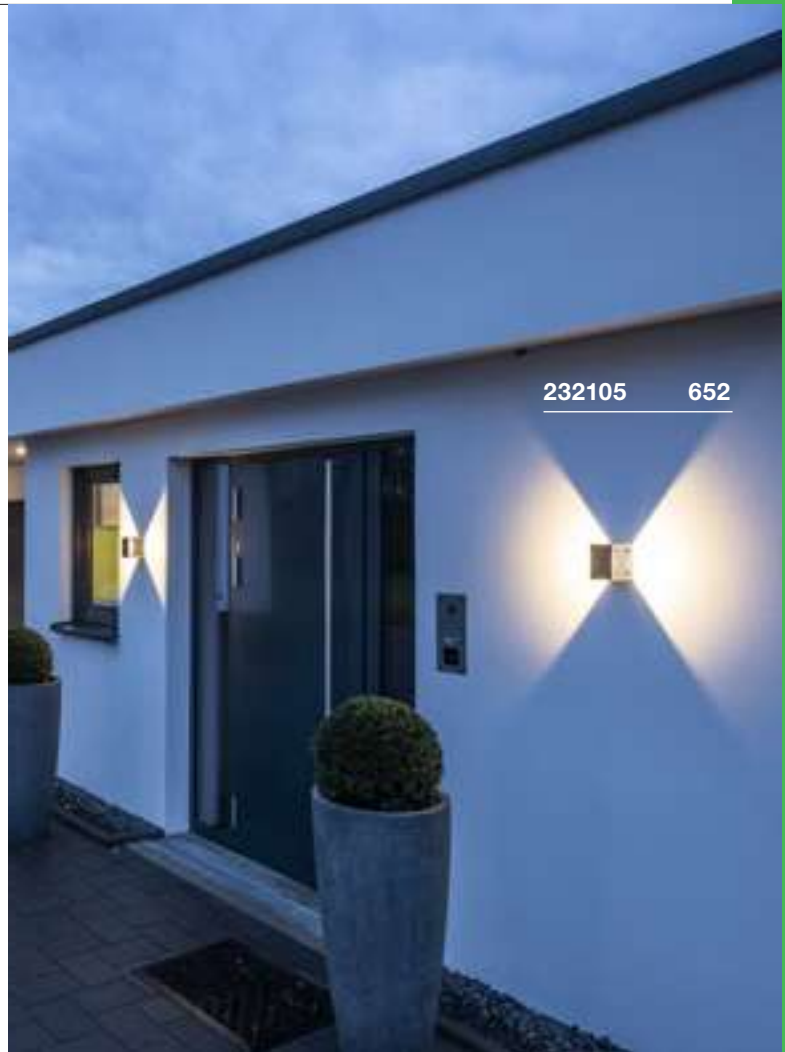



1002902 655



229664 655



1002605 655

OUT-BEAM UP/
FLOOD DOWN
WL

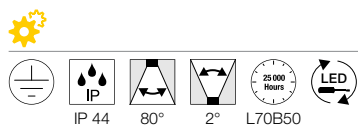
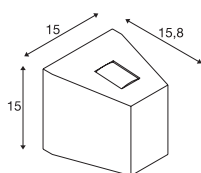
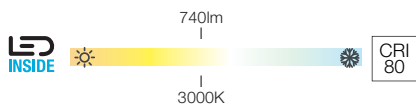

220-240V ~50/60Hz | 500mA
Systemleistung: 18W
Material: Aluminium / Glas

Down	690lm 3000K		
Beam	50lm 3000K		

Variante	Art. Nr.
Down: 690lm 3000K CRI80 Beam: 50lm 3000K CRI80	
anthrazit	229665
Down: 690lm 3000K CRI80 Beam: 50lm 3000K CRI80	
grau	229664

MANA OUT
WL, PHASE

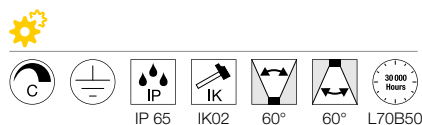
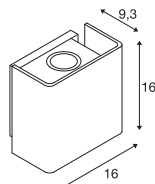
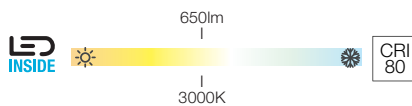

220-240V ~50/60Hz | 500mA
Systemleistung: 11W
Material: Aluminium / Aluminium

Up/Down	325lm 3000K		

Variante	Art. Nr.
Up: 325lm 3000K CRI80 Down: 325lm 3000K CRI80	
anthrazit	1002900
Up: 325lm 3000K CRI80 Down: 325lm 3000K CRI80	
rost	1002902

SAIL
WL

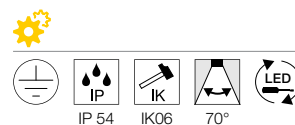
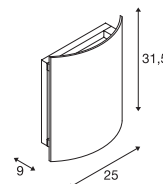
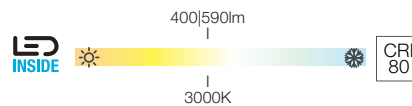

200-240V ~50Hz
Systemleistung: 18W
Material: Aluminium

1002605, 1002606	400lm 590lm 3000K		

Variante	Art. Nr.
400lm 3000K CRI80	
anthrazit	1002605
590lm 3000K CRI80	
weiß	1002606

L-LINE OUT
WL



500lm / 570lm

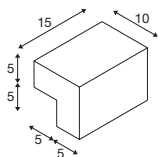

220-240V ~50/60Hz | 350mA
Systemleistung: 7W
Material: Aluminium / Polycarbonat (PC)

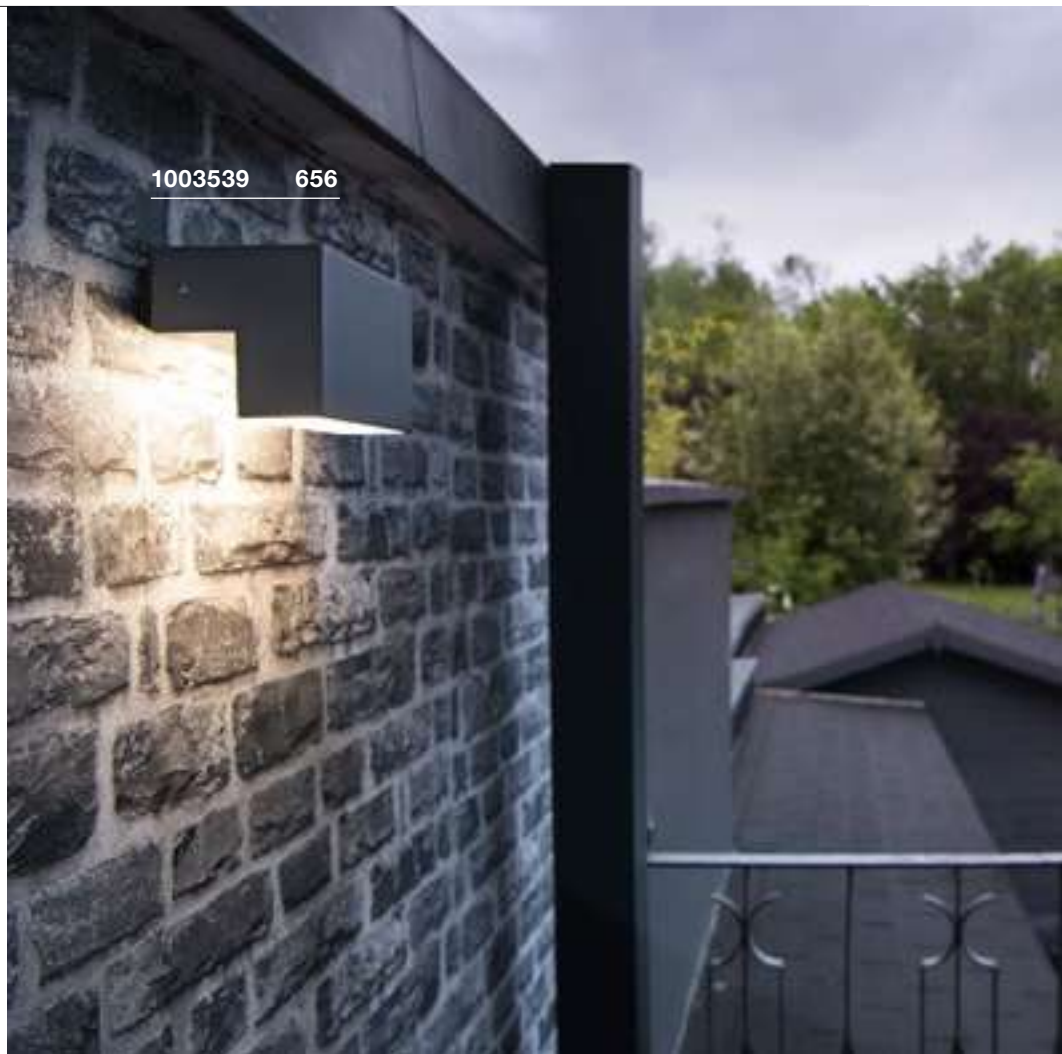

1003539	500/570lm 3000/4000K	A → G
		A → G

Variante	Art. Nr.
500/570lm 3000/4000K CRI80	
■ anthrazit	1003539



1000820 657

PHOTONIA
WL, E27

MOLAT
WL, E27

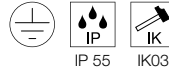
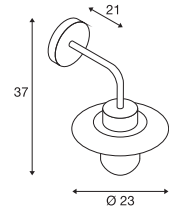
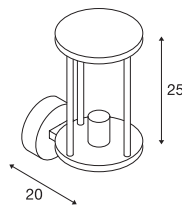

220-240V ~50/60Hz
Material: Aluminium / Glas

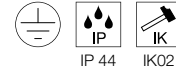

220-240V ~50/60Hz
Material: Aluminium / Glas



E27 <60W
Ø: 9 cm L: 15 cm



E27 60W
Ø: 6,5 cm L: 14,5 cm



LED E27 | 7,5W | 320°
2500K | 700lm | EEK=F
8kWh/1000h



Art. Nr. 1005265



LED E27 | 7,5W | 320°
2700K | 800lm | EEK=F
8kWh/1000h



Art. Nr. 1005268



Abstandshalter
Art. Nr. 1002853



Variante	Art. Nr.
1xE27	
■ anthrazit	232045

Variante	Art. Nr.
1xE27	
■ anthrazit	1000820

GLOO PURE
WL, E27



APONI
WL, PHASE



<23 W



CRI 80

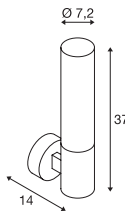
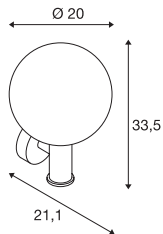

220-240V ~50/60Hz
Material: Aluminium / Glas

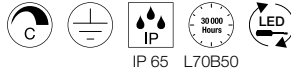

220-240V ~50/60Hz | 500mA
Systemleistung: 6.3W
Material: Aluminium



E27 <23W
Ø: 4,8 cm L: 18 cm



LED E27 | 8W | 240°
3000K | 870lm | EEK=E
8kWh/1000h



Art. Nr. 1005289



		A → G
1000681	520lm 3000K	A → G E



Abstandshalter
Art. Nr. 1002853



Variante	Art. Nr.
1xE27	
anthrazit	1002002

Variante	Art. Nr.
520lm 3000K CRI80	
anthrazit	1000681



231465 659



1000682 558

C-POL
WL, E27

F-POL
WL, E27

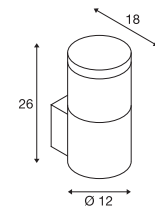
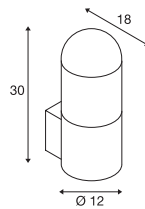
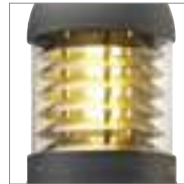

IP 54

220-240V ~50/60Hz
Material: Aluminium / Polycarbonat (PC)



IP 54

220-240V ~50/60Hz
Material: Aluminium / Polycarbonat (PC)



E27 <24W
Ø: 5,2 cm L: 17,3 cm



LED E27 | 13.5W | 240°
3000K | 1520lm | EEK=E
14kWh/1000h

Art. Nr. 1005307



E27 <20W
Ø: 5 cm L: 14 cm



LED E27 | 8W | 240°
3000K | 870lm | EEK=E
8kWh/1000h

Art. Nr. 1005289



Variante	Art. Nr.
1xE27	
■ anthrazit	231465

Variante	Art. Nr.
1xE27	
■ anthrazit	231585

BIG NAILS
WL, E27



SQUARE
WL, E27

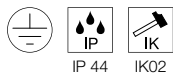
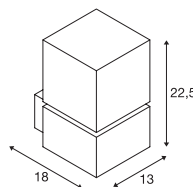
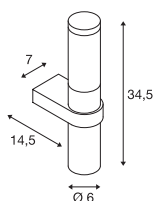

220-240V ~50/60Hz
Material: Edelstahl 304 / Polycarbonat (PC)

220-240V ~50/60Hz
Material: Edelstahl 304



E27 <15W
Ø: 4,5 cm L: 17 cm



E27 <20W
Ø: 7 cm L: 13 cm



LED E27 | 8W | 240°
3000K | 880lm | EEK=E
8kWh/1000h



Art. Nr. 1005289



LED E27 | 9W | 220°
2700K | 770lm | EEK=F
9kWh/1000h



Art. Nr. 1005301

Variante	Art. Nr.
1xE27	
■ edelstahl	229182

Variante	Art. Nr.
1xE27	
■ edelstahl	1000336

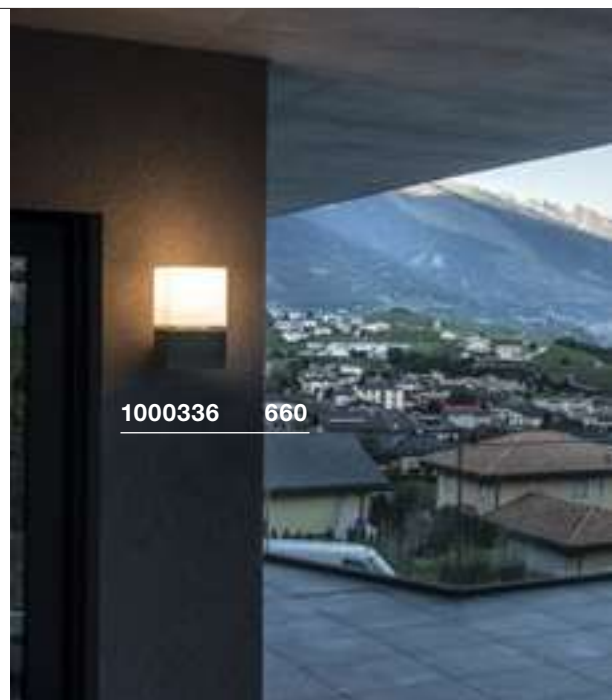

1000336 660

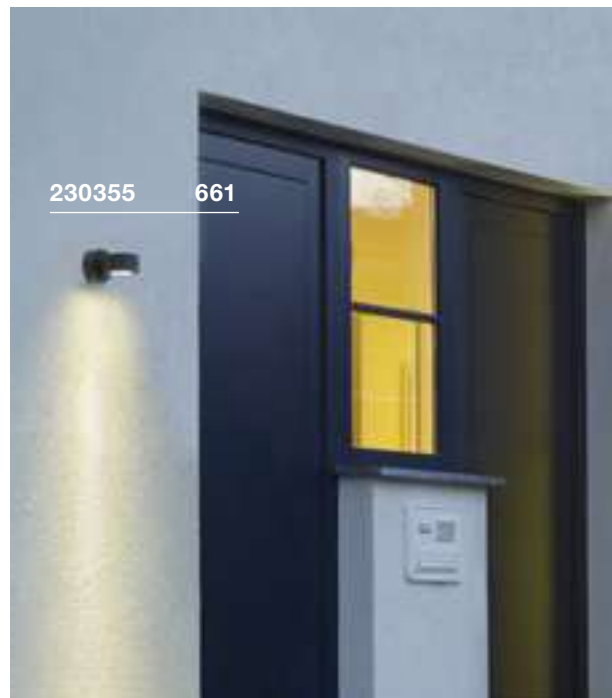

230355 661



1000797 661

KERAS ELT
WL, E27

SITRA
WL, TCR-TSE

RASCALI
WL

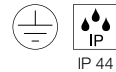
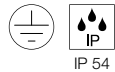
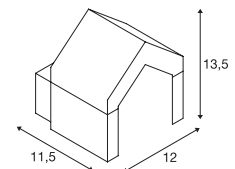
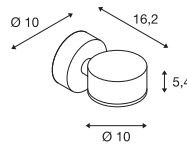
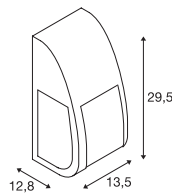
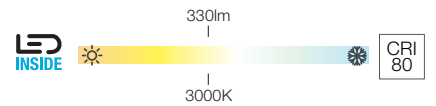

220-240V ~50/60Hz
Material: Aluminium / Polycarbonat (PC)

220-240V ~50/60Hz
Material: Aluminium / Glas

220-240V ~50/60Hz
Systemleistung: 8W
Material: Aluminium



E27 <25W
Ø: 7 cm L: 17,5 cm



GX53 <9W
Ø: 7,5 cm L: 3,5 cm



LED E27 | 13,5W | 220°
2700K | 1300lm | EEK=F
13kWh/1000h



LED GX53 | 6W | 120°
3000K | 500lm | EEK=G
6kWh/1000h



Art. Nr. 1005302

Art. Nr. 1005271



1000797	330lm 3000K	

Variante	Art. Nr.
1xE27	
■ anthrazit	227176

Variante	Art. Nr.
1xGX53	
■ anthrazit	230355

Variante	Art. Nr.
330lm 3000K CRI80	
■ anthrazit	1000797

IPERI
WL

QUADRASYL
WL, TCR-TSE

SQUARE TURN
WL, G9

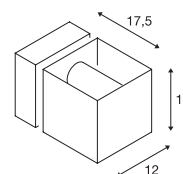
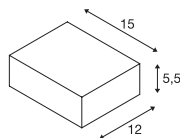
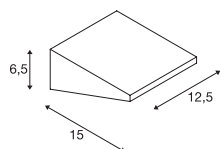
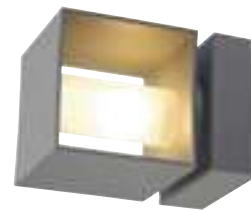

220-240V ~50/60Hz
Systemleistung: 4,5W
Material: Aluminium / Kunststoff

- Schutzart IP44 nur bei Montage mit Lichtaustritt nach unten.



220-240V ~50/60Hz
Material: Aluminium / Glas

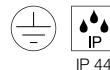

220-240V ~50/60Hz
Material: Aluminium / Glas



231315	400lm 4000K	



GX53 <11W
Ø: 7,5 cm L: 2,7 cm



LED GX53 | 6W | 120°
4000K | 550lm | EEK=F
6kWh/1000h

Art. Nr. 1005269



G9 <42W
Ø: 3,5 cm L: 8 cm



LED G9 | 3.7W | 300°
3000K | 430lm | EEK=E
4kWh/1000h

Art. Nr. 1005286



Variante	Art. Nr.
400lm 4000K CRI80 ■ anthrazit	231315

Variante	Art. Nr.
1xGX53 ■ anthrazit	232285

Variante	Art. Nr.
1xG9 ■ grau	1000335



1000335 662



232285 662



231315 662

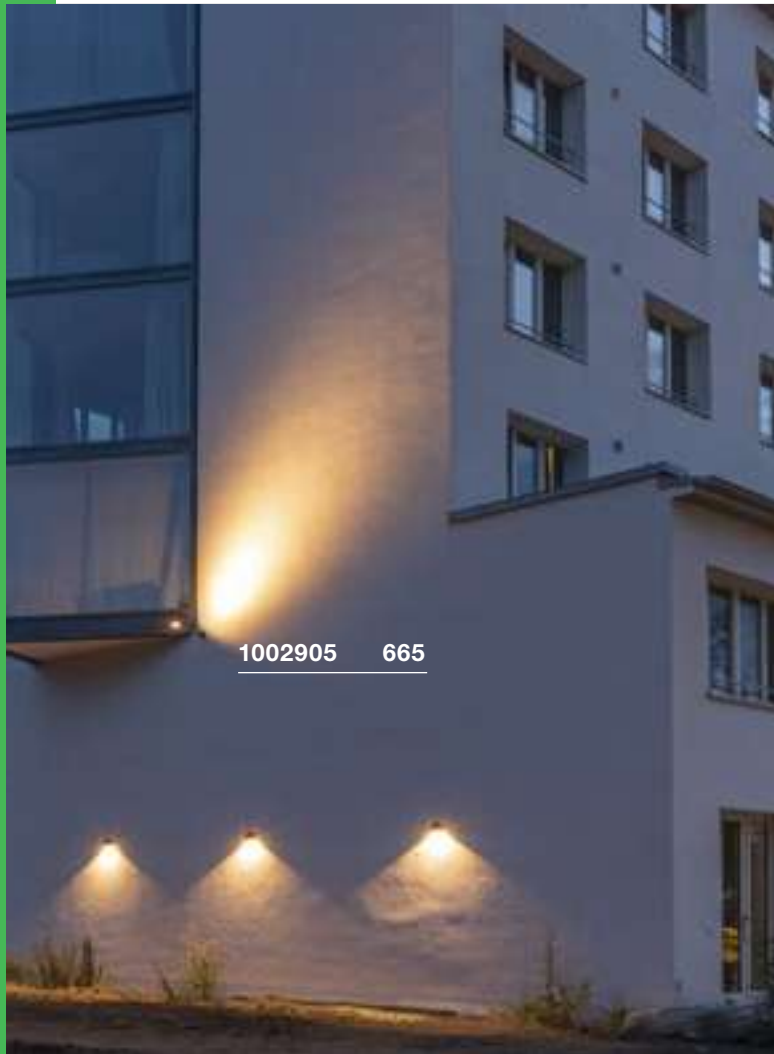

TODAY PRO
Display

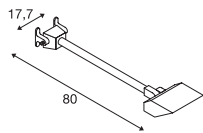
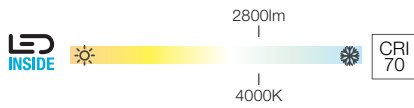

220-240V ~50/60Hz | 640mA
Systemleistung: 29W
Material: Aluminium

1000880, 1000881	2800lm 4000K	

Variante	Art. Nr.
2800lm 4000K CRI70 ■ schwarz	1000880
2800lm 4000K CRI70 □ weiß	1000881

ESKINA D
Display, PHASE

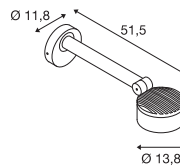

220-240V ~50/60Hz | 350mA
Systemleistung: 14,5W
Material: Aluminium

1002905	1000lm 3000/4000K	

Variante	Art. Nr.
1000lm 3000/4000K CRI80 ■ anthrazit	1002905

MYRA DISPLAY
WL, curved, QPAR51

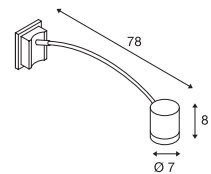
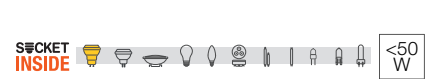

220-240V ~50/60Hz
Material: Aluminium

GU10 <50W Ø: 5 cm L: 5,7 cm		

Art. Nr. 1004972

Variante	Art. Nr.
1xGU10 ■ anthrazit	233135
1xGU10 ■ grau	233134

LED SPOT
SP

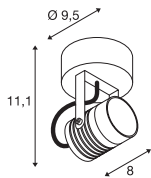
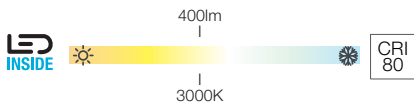

IP 55 IK06 40° L80B50 330° 180°

100-240V ~50/60Hz | 240mA
Systemleistung: 6W
Material: Aluminium / Glas

1004649, 1004957	400lm 3000K	

NAUTILUS | Montageplatte
Art. Nr. 1002884

Variante	Art. Nr.
400lm 3000K CRI80	
anthrazit	1004649
400lm 3000K CRI80	
rost	1004957

NAUTILUS
WL QPAR51

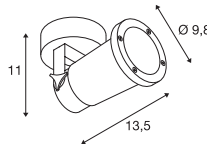
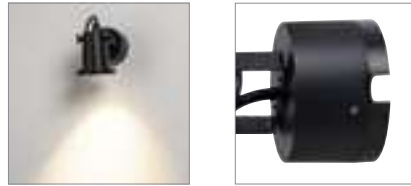

IP 54 IK02 330° 180°

220-240V ~50/60Hz
Material: Aluminium

GU10 <11W
Ø: 5 cm L: 8,3 cm

LED GU10 51mm | 4W | 36°
2700K | 270lm | EEK=G
4kWh/1000h

Art. Nr. 1004972

NAUTILUS | Montageplatte
Art. Nr. 1002884

Variante	Art. Nr.
1xGU10	
schwarz	1002867

MYRA
CW, single, QPAR51

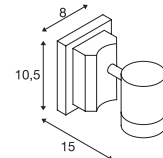

IP 55 340° 45°

220-240V ~50/60Hz
Material: Aluminium / Glas
• Adapterrahmen zur Aufputzmontage erhältlich

GU10 <50W
Ø: 5 cm L: 5,7 cm

LED GU10 51mm | 4W | 36°
3000K | 270lm | EEK=G
4kWh/1000h

Art. Nr. 1004973

Aufbaumontage Rahmen
Art. Nr. 233215

Variante	Art. Nr.
1xGU10	
anthrazit	233105
1xGU10	
grau	233104

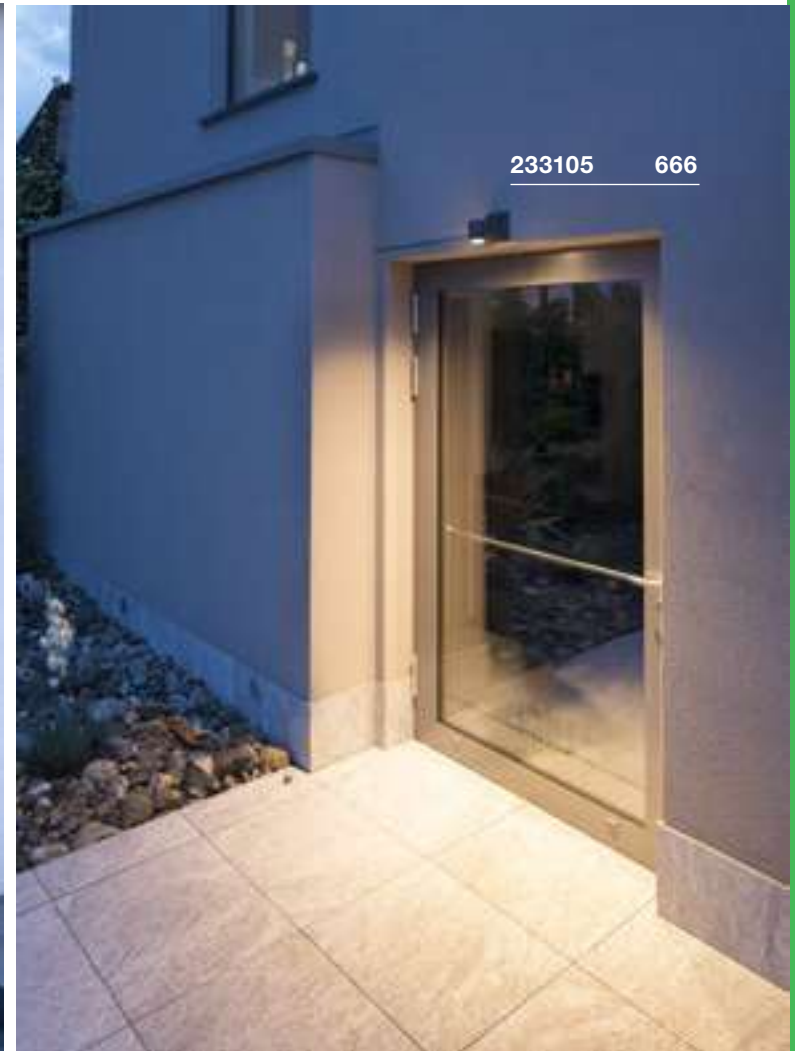
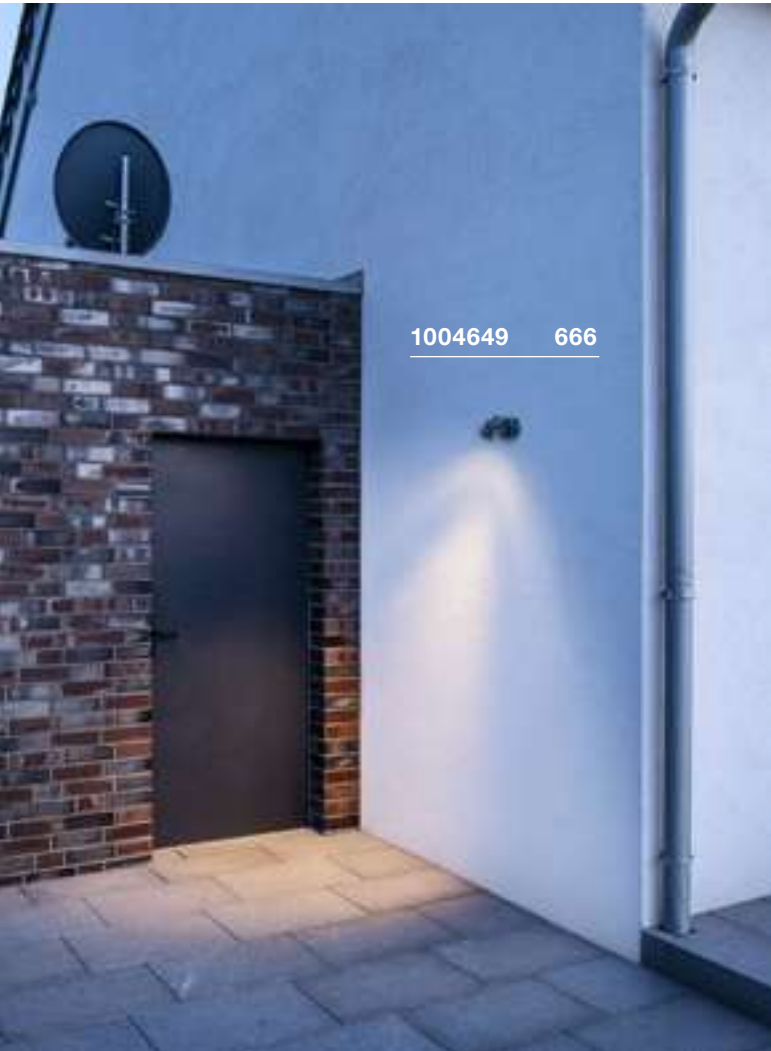

DECKENLEUCHTEN



1003442 619

234515 619



1003421 672



1003427 + 1005207 671 + 617

ENOLA ROUND S
CL

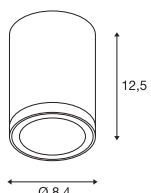
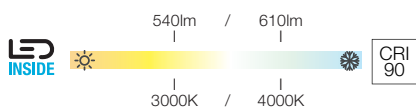

220-240V ~50/60Hz | 500mA
Systemleistung: 9W
Material: Aluminium / Glas

ENOLA ROUND M
CL

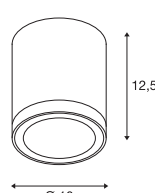
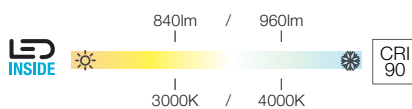

220-240V ~50/60Hz | 500mA
Systemleistung: 11W
Material: Aluminium / Glas

ENOLA ROUND L
CL

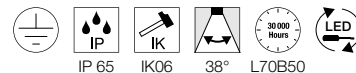
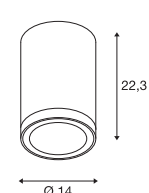
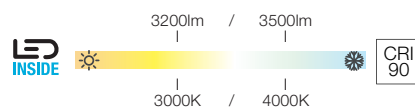

220-240V ~50/60Hz | 900mA
Systemleistung: 36W
Material: Aluminium / Glas



1003426	540/610lm 3000/4000K	



Art. Nr. 1003479	
Art. Nr. 1005262	

Variante	Art. Nr.
540/610lm 3000/4000K CRI90	
■ anthrazit	1003426



1003427	840/960lm 3000/4000K	



Art. Nr. 1003479			
Art. Nr. 1005205			
Art. Nr. 1005206			
Art. Nr. 1005207			

Variante	Art. Nr.
840/960lm 3000/4000K CRI90	
■ anthrazit	1003427



1003442	3200/3500lm 3000/4000K	



Art. Nr. 1003479	
Art. Nr. 1005263	

Variante	Art. Nr.
3200/3500lm 3000/4000K CRI90	
■ anthrazit	1003442

ENOLA SQUARE S
CL

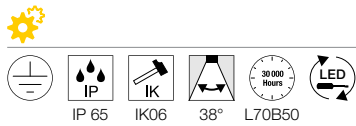
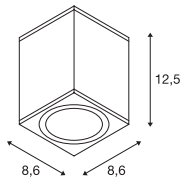
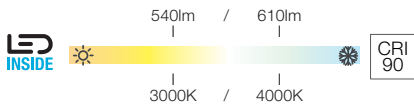

220-240V ~50/60Hz | 500mA
Systemleistung: 9W
Material: Aluminium / Glas

ENOLA SQUARE M
CL

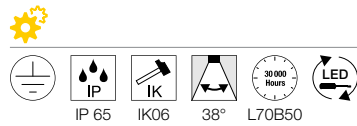
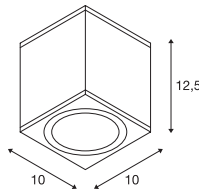
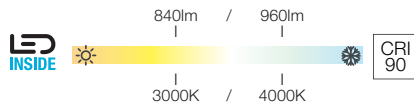

220-240V ~50/60Hz | 500mA
Systemleistung: 11W
Material: Aluminium / Glas

ENOLA SQUARE L
CL

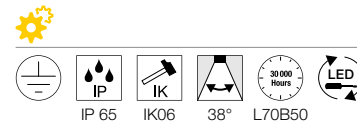
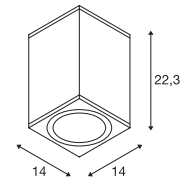

220-240V ~50/60Hz | 900mA
Systemleistung: 36W
Material: Aluminium / Glas

1003420	540/610lm 3000/4000K	

- Abstandshalter
Art. Nr. 1003479
- Reflektor 60°
Art. Nr. 1005262

1003421	840/960lm 3000/4000K	

- Abstandshalter
Art. Nr. 1003479
- Linse 19°
Art. Nr. 1005205
- Linse asymmetrisch
Art. Nr. 1005206
- Reflektor 60°
Art. Nr. 1005207

1003439	3200/3500lm 3000/4000K	

- Abstandshalter
Art. Nr. 1003479
- Reflektor 60°
Art. Nr. 1005263

Variante	Art. Nr.
540/610lm 3000/4000K CRI90	
■ anthrazit	1003420

Variante	Art. Nr.
840/960lm 3000/4000K CRI90	
■ anthrazit	1003421

Variante	Art. Nr.
3200/3500lm 3000/4000K CRI90	
■ anthrazit	1003439



1003421 + 1005207 672 + 617

BIG THEO
CL



BIG THEO
CL, QPAR111

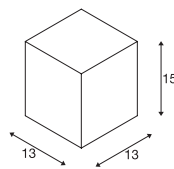
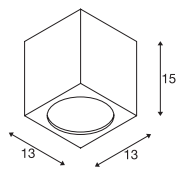
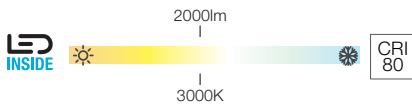

100-277V ~50/60Hz | 500mA
Systemleistung: 21W
Material: Aluminium / Glas



220-240V ~50/60Hz
Material: Aluminium / Glas



234535	2000lm 3000K	



GU10 <75W



LED QPAR111 | 8W | 38°
2700K | 680lm | EEK=F
8kWh/1000h



Art. Nr. 1005274

Variante	Art. Nr.
2000lm 3000K CRI80	
■ anthrazit	234535

Variante	Art. Nr.
1xGU10	
■ anthrazit	229555
1xGU10	
□ weiß	229551
1xGU10	
■ grau	229554



234535 674



1005202 675

QUADRULO
CL



NEW

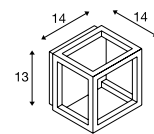
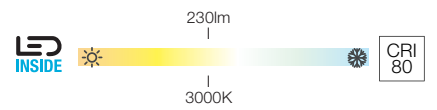
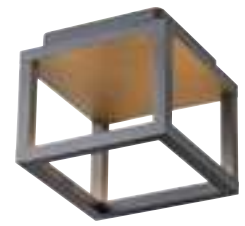

100-277V ~50/60Hz | 480mA
 Systemleistung: 7,5W
 Material: Aluminium / Acryl



1005202	230lm 3000K	

Variante	Art. Nr.
230lm 3000K CRI80 ■ anthrazit	1005202 ■

OVALISK
CL



1004677 676

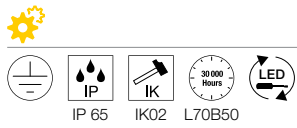
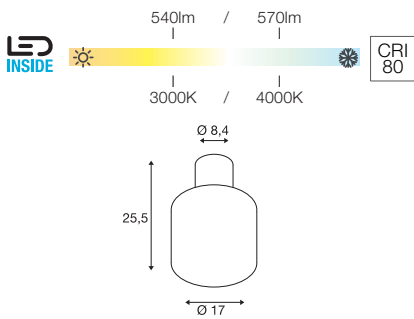

220-240V ~50/60Hz | 350mA
Systemleistung: 7.9W
Material: Aluminium / Glas



1004677	540/570lm 3000/4000K	

Variante	Art. Nr.
540/570lm 3000/4000K CRI80	
■ anthrazit	1004677



232055 677

PHOTONIA
CL, E27

MOLAT
CL, E27

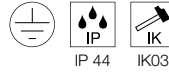
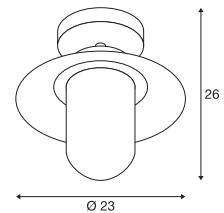
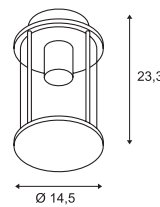

220-240V ~50/60Hz
Material: Aluminium / Glas



220-240V ~50/60Hz
Material: Aluminium / Glas



E27 <60W
Ø: 9 cm L: 15 cm



E27 <60W
Ø: 6,5 cm L: 14,5 cm



LED E27 | 7,5W | 320°
2500K | 700lm | EEK=F
8kWh/1000h



Art. Nr. 1005265



LED E27 | 7,5W | 320°
2700K | 800lm | EEK=F
8kWh/1000h



Art. Nr. 1005268



Abstandshalter
Art. Nr. 1002853



Variante	Art. Nr.
1xE27	
■ anthrazit	232055

Variante	Art. Nr.
1xE27	
■ anthrazit	1000823

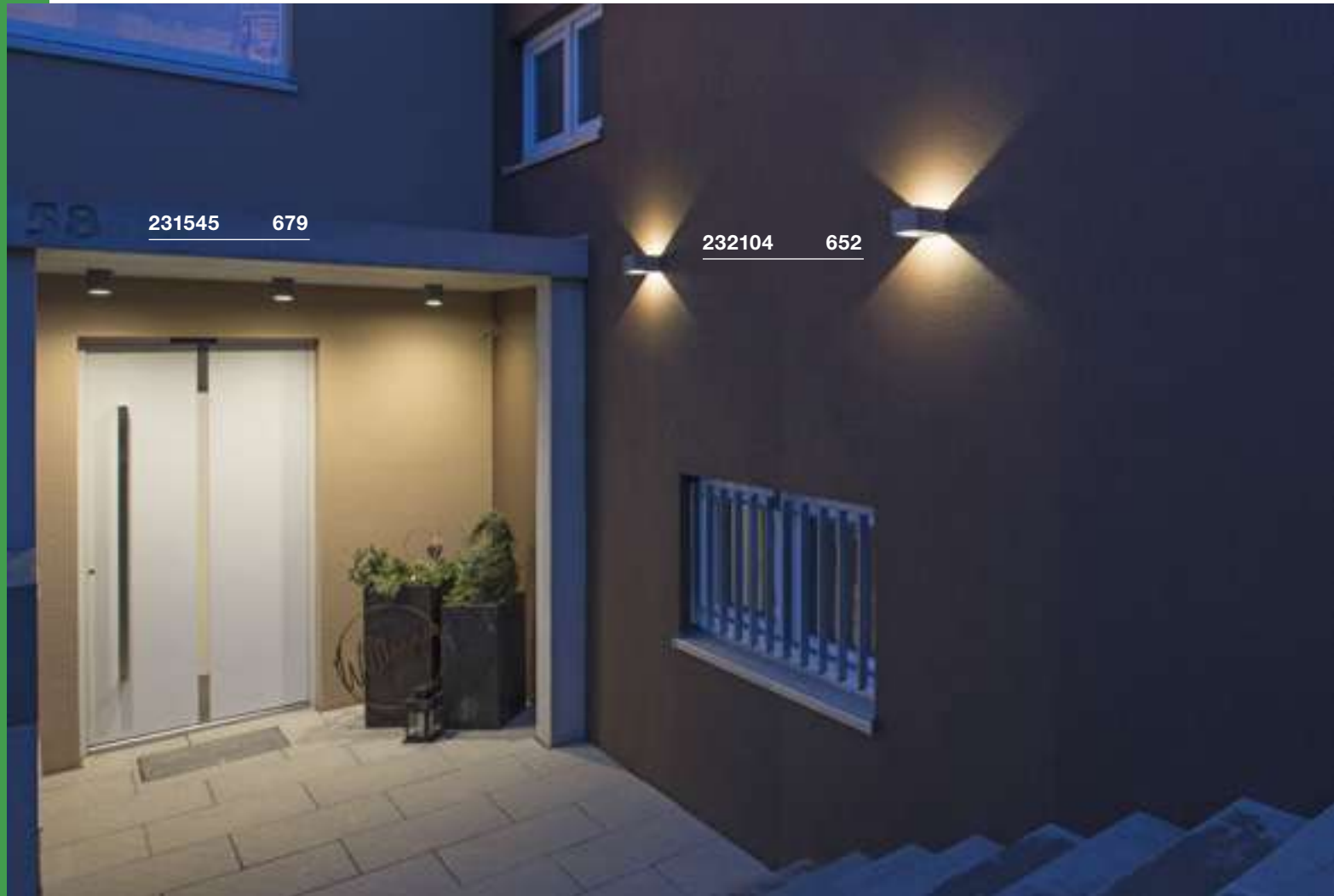

SITRA
CL, TCR-TSE



<9 W

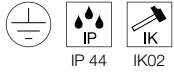
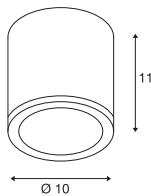

220-240V ~50/60Hz
Material: Aluminium / Glas

ROX
CL, QPAR111



<50 W

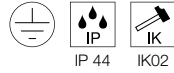
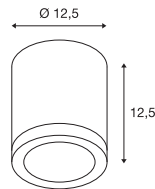

220-240V ~50/60Hz
Material: Aluminium / Glas

ROX
CL, GX53



<11 W

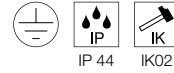
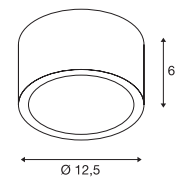

220-240V ~50/60Hz
Material: Aluminium / Glas



GX53 <9W
Ø: 7,5 cm L: 3,5 cm



LED GX53 | 6.1W | 120°
4000K | 490lm | EEK=G
6kWh/1000h



Art. Nr. 1005271



GU10 <50W



LED QPAR111 | 8W | 38°
2700K | 680lm | EEK=F
8kWh/1000h



Art. Nr. 1005274



GX53 <11W
Ø: 7,5 cm L: 3,5 cm



LED GX53 | 6W | 120°
4000K | 550lm | EEK=F
6kWh/1000h



Art. Nr. 1005269

Variante	Art. Nr.
1xGX53	
■ anthrazit	231545
1xGX53	
□ weiß	231541

Variante	Art. Nr.
1xGU10	
■ aluminium	1000332

Variante	Art. Nr.
1xGX53	
■ aluminium	1000339

WAND- UND DECKENLEUCHTEN



1005089 690



ESKINA SPOT SENSOR
CW, PHASE



1002904 682

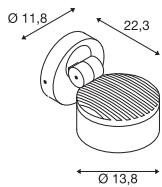
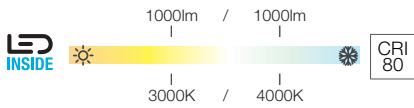

IP 54 IK02 95° L70B50 340°

 105° 20

220-240V ~50/60Hz | 350mA
Systemleistung: 14,5W
Material: Aluminium



1002904	1000lm 3000/4000K	

Variante	Art. Nr.
1000lm 3000/4000K CRI80	
■ anthrazit	1002904



ESKINA SPOT
CW, PHASE

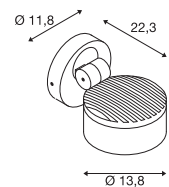
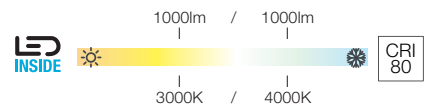

220-240V ~50/60Hz | 350mA
Systemleistung: 14,5W
Material: Aluminium



		A → G
1002903	1000lm 3000/4000K	A → G E

Variante	Art. Nr.
1000lm 3000/4000K CRI80	
■ anthrazit	1002903

SITRA 360
CW, TCR-TSE



THEO BRACKET
CW

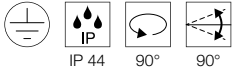
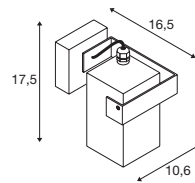
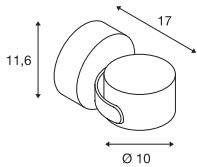

220-240V ~50/60Hz
Material: Aluminium / Glas

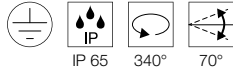

220-240V ~50/60Hz
Material: Aluminium / Glas



GX53 <9W
Ø: 7,5 cm L: 3,5 cm



LED GX53 | 6.1W | 120°
4000K | 490lm | EEK=G
6kWh/1000h



Art. Nr. 1005271



GU10 <7W
Ø: 5,1 cm L: 5,7 cm



LED GU10 51mm | 4W | 36°
2700K | 270lm | EEK=G
4kWh/1000h



Art. Nr. 1004972

Variante	Art. Nr.
1xGX53	
■ anthrazit	231515

Variante	Art. Nr.
1xGU10	
■ anthrazit	1004653





HELIA
CW, single, PHASE



HELIA
CW, double, PHASE

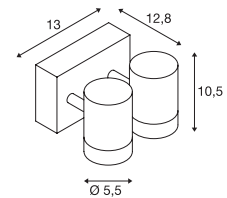
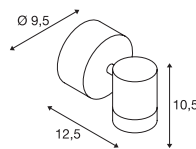
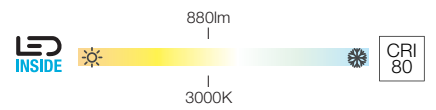
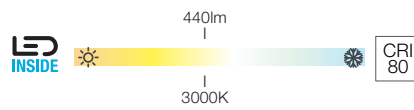
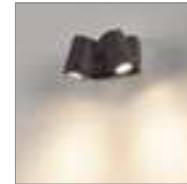
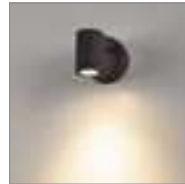

220-240V ~50/60Hz | 500mA
Systemleistung: 6,5W
Material: Aluminium / Glas

220-240V ~50/60Hz | 500mA
Systemleistung: 13W
Material: Aluminium / Glas

233245	440lm 3000K	

233255	880lm 3000K	

■ Abstandshalter
Art. Nr. 1002853

■ Abstandshalter
Art. Nr. 1002853

Variante	Art. Nr.
440lm 3000K CRI80 ■ anthrazit	233245

Variante	Art. Nr.
880lm 3000K CRI80 ■ anthrazit	233255

MYRA
WL, double, QPAR51

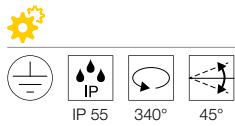
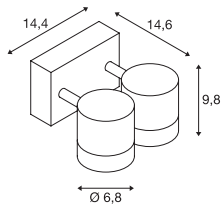

220-240V ~50/60Hz
Material: Aluminium / Glas

OUT-BEAM FRAME
SP

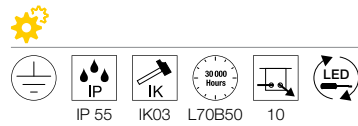
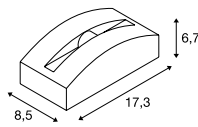
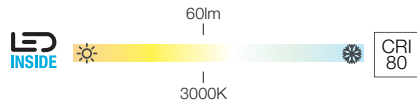

100-277V ~50/60Hz | 700mA
Systemleistung: 3,5W
Material: Aluminium / Acryl

BOX-L
WL

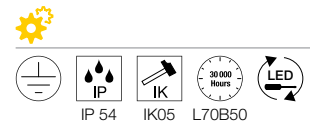
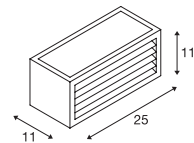
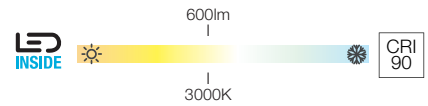

100-277V ~50/60Hz | 500mA
Systemleistung: 19W
Material: Aluminium / Acryl

GU10 <50W
Ø: 5 cm L: 5,7 cm

LED GU10 51mm | 6W | 38°
3000K | 470lm | EEK=F
6kWh/1000h

Art. Nr. 1005079

Abstandshalter
Art. Nr. 1002853

Variante	Art. Nr.
2xGU10	
■ anthrazit	233095
2xGU10	
■ grau	233094

Art. Nr.	60lm 3000K	A → G
1003518, 1003519		A → G

Variante	Art. Nr.
60lm 3000K CRI80	
■ anthrazit	1003518
60lm 3000K CRI80	
□ weiß	1003519

Art. Nr.	600lm 3000K	A → G
1002035		A → G

Variante	Art. Nr.
600lm 3000K CRI90	
■ anthrazit	1002035



1002035 686



1003518 687

AINOS
CW

AINOS
CW SENSOR

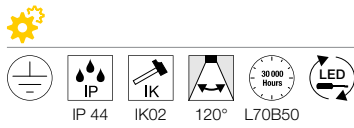
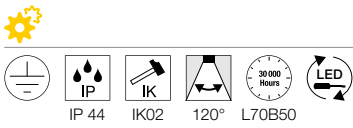
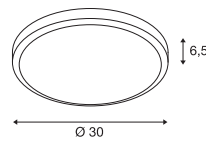
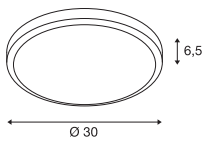
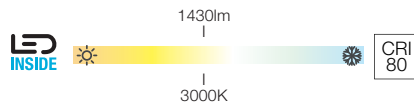
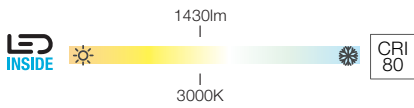
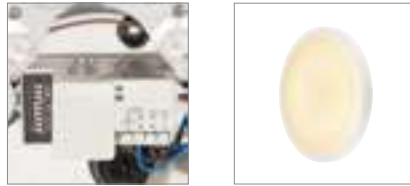

220-240V ~50/60Hz | 500mA
Systemleistung: 21W
Material: Aluminium / Polycarbonat (PC)

220-240V ~50/60Hz | 500mA
Systemleistung: 22W
Material: Aluminium / Polycarbonat (PC)

229965, 229961	1430lm 3000K	

229975, 229971	1430lm 3000K	

Variante	Art. Nr.
1430lm 3000K CRI80	
■ anthrazit	229965
1430lm 3000K CRI80	
□ weiß	229961

Variante	Art. Nr.
1430lm 3000K CRI80	
■ anthrazit	229975
1430lm 3000K CRI80	
□ weiß	229971





AINOS
CW, quadratisch

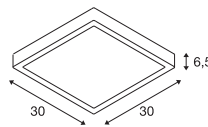
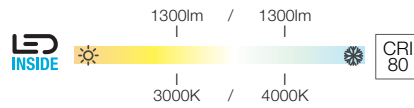

AINOS
CW SENSOR, quadratisch

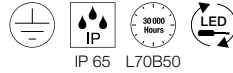
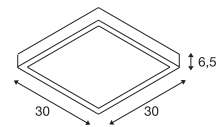
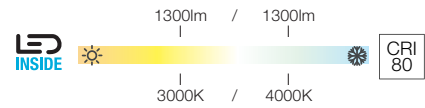

220-240V ~50/60Hz | 500mA
Systemleistung: 17W
Material: Aluminium / Polycarbonat (PC)

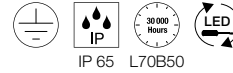

220-240V ~50/60Hz | 500mA
Systemleistung: 18W
Material: Aluminium / Polycarbonat (PC)



1003450, 1003449	1300lm 3000/4000K	

Variante	Art. Nr.
1300lm 3000/4000K CRI80	
anthrazit	1003450
1300lm 3000/4000K CRI80	
weiß	1003449



1003452, 1003451	1300lm 3000/4000K	

Variante	Art. Nr.
1300lm 3000/4000K CRI80	
anthrazit	1003452
1300lm 3000/4000K CRI80	
weiß	1003451

LIPA
CW, PHASE

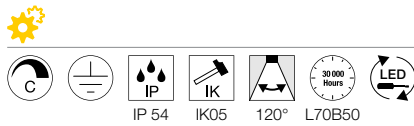
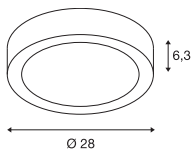
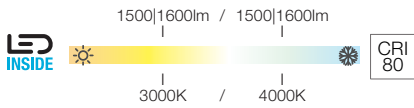

220-240V ~50/60Hz | 500mA
Systemleistung: 21W
Material: Aluminium / Polycarbonat (PC)

RUBA 27/42
CW

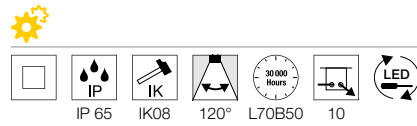
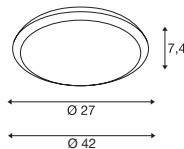
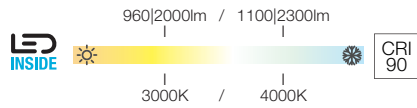

220-240V ~50/60Hz | 300mA
Systemleistung: 12W
Material: Polycarbonat (PC)

1001856, 1001855	1500lm 1600lm 3000/4000K	

Variante	Art. Nr.
1500lm 3000/4000K CRI80	
anthrazit	1001856
1600lm 3000/4000K CRI80	
weiß	1001855

Die Informationen zur Energieeffizienzklasse für dieses Produkt lagen bei Druck noch nicht vor. Die aktuellsten Produktdaten finden Sie jederzeit unter www.slv.com

Variante	Art. Nr.
960/1100lm 3000/4000K CRI90 Ø: 27 cm	
weiß	1005089
2000/2300lm 3000/4000K CRI90 Ø: 42 cm	
weiß	1005090



1005089/90 690





229085 691

BULAN
CW, E14

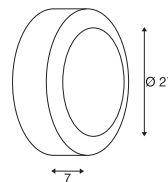

220-240V ~50/60Hz
Material: Aluminium / Glas



E14 <60W
Ø: 4,8 cm L: 13 cm



LED E14 | 4.2W | 320°
2700K | 350lm | EEK=G
5kWh/1000h



Art. Nr. 1005285

Variante	Art. Nr.
1xE14	
■ anthrazit	229075
1xE14	
□ weiß	229071
1xE14	
■ grau	229072

BULAN GRID
CW, E27

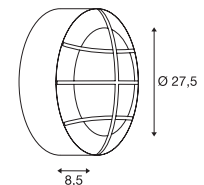
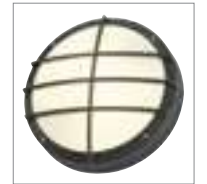

220-240V ~50/60Hz
Material: Aluminium / Polycarbonat (PC)



E27 <25W
Ø: 5,2 cm L: 17,3 cm



LED E27 | 8W | 240°
3000K | 870lm | EEK=E
8kWh/1000h



Art. Nr. 1005289

Variante	Art. Nr.
2xE27	
■ anthrazit	229085
2xE27	
□ weiß	229081

TERANG 200
CW

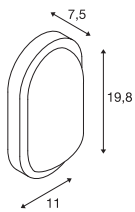
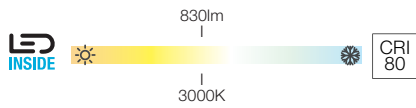
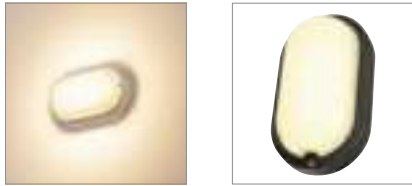

220-240V ~50/60Hz
Systemleistung: 11W
Material: Aluminium / Polycarbonat (PC)

IMPERVA 120
CW

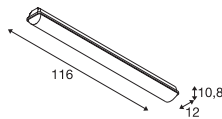
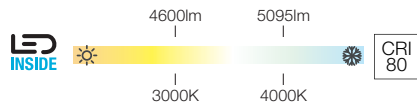

220-240V ~50/60Hz | 700mA
Systemleistung: 40W
Material: Polycarbonat (PC)

IMPERVA 150
CW

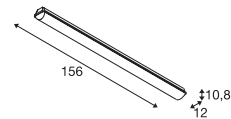
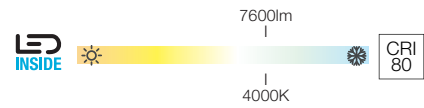

220-240V ~50/60Hz | 1050mA
Systemleistung: 55W
Material: Polycarbonat (PC)

229935, 229931	830lm 3000K	

1001314, 1001315	4600lm 5095lm 3000K 4000K	

1001317	7600lm 4000K	

Variante	Art. Nr.
830lm 3000K CRI80	
■ anthrazit	229935
830lm 3000K CRI80	
□ weiß	229931

Variante	Art. Nr.
4600lm 3000K CRI80	
■ grau	1001314
5095lm 4000K CRI80	
■ grau	1001315

Variante	Art. Nr.
7600lm 4000K CRI80	
■ grau	1001317



229935 692



1001317 692

HART IM NEHMEN.

EINBAULEUCHTEN BRINGEN
LICHT MIT SICHERHEIT.

Für jeden Anwendungsfall ist hier das richtige Produkt zu finden. Dank hochwertiger Ausführung, ausgesuchten Materialien, unterschiedlicher IP-Schutzarten und Technologien.





1006106 717



1002898 719



EINBAULEUCHTEN



Weitere Leuchten und Varianten finden Sie online unter www.slv.com
 Herstellerangaben unserer Leuchtmittelempfehlungen finden Sie im Kapitel Leuchtmittel ab Seite 808

WANDEINBAULEUCHTEN



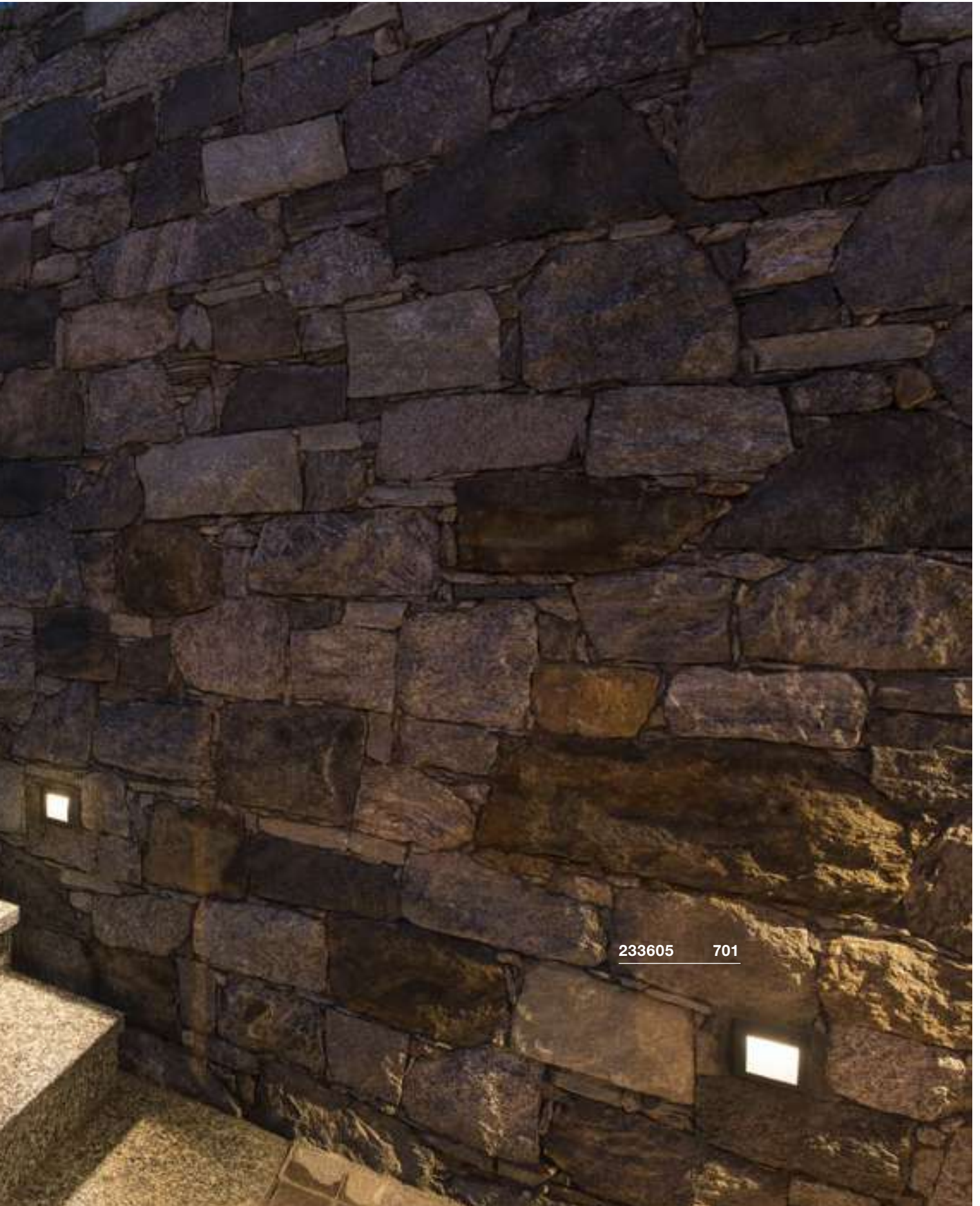

233605 701

ADI
EL

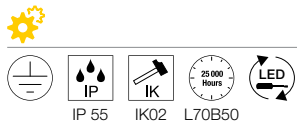
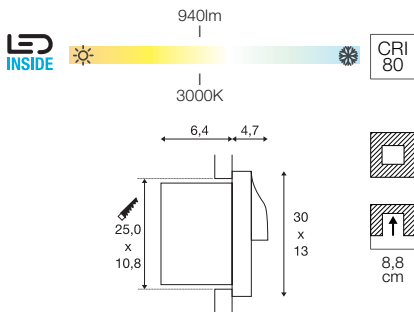

100-277V ~50/60Hz | 500mA
Systemleistung: 18W
Material: Aluminium / Polycarbonat (PC)

- Leuchte nur mit Lichtaustritt nach unten montieren

233635	940lm 3000K	A → G A E

Einbautopf
Art. Nr. 233639

Variante	Art. Nr.
940lm 3000K CRI80 ■ anthrazit	233635



DOWNUNDER OUT S EL

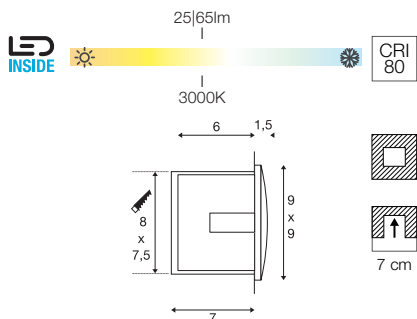

LED INSIDE
IP 55 L70B50

220-240V ~50/60Hz | 300mA
Systemleistung: 1.7W
Material: Aluminium / Kunststoff

- Leuchte nur mit Lichtaustritt nach unten montieren

DOWNUNDER OUT M EL

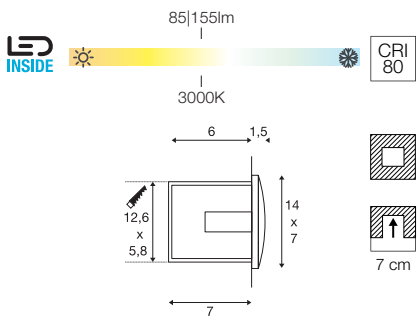

LED INSIDE
IP 55 L70B50

220-240V ~50/60Hz | 300mA
Systemleistung: 4W
Material: Aluminium / Kunststoff

- Leuchte nur mit Lichtaustritt nach unten montieren

DOWNUNDER OUT L EL

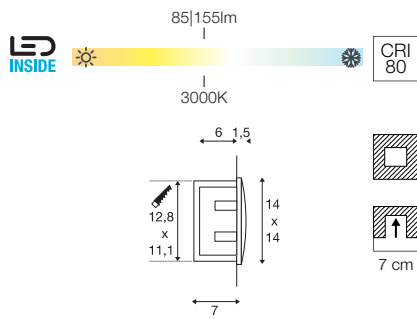

LED INSIDE
IP 55 L70B50

220-240V ~50/60Hz | 300mA
Systemleistung: 4W
Material: Aluminium / Kunststoff

- Leuchte nur mit Lichtaustritt nach unten montieren

		A → G
233605, 233601	25lm 65lm 3000K	A → G D

Variante	Art. Nr.
25lm 3000K CRI80 ■ anthrazit / schwarz	233605
65lm 3000K CRI80 ■ weiß / schwarz	233601

		A → G
233625, 233621	85lm 155lm 3000K	A → G E

Variante	Art. Nr.
85lm 3000K CRI80 ■ anthrazit / schwarz	233625
155lm 3000K CRI80 ■ weiß / schwarz	233621

		A → G
233615, 233611	85lm 155lm 3000K	A → G E

Variante	Art. Nr.
85lm 3000K CRI80 ■ anthrazit / schwarz	233615
155lm 3000K CRI80 ■ weiß / schwarz	233611

BRICK MESH
EL, E14

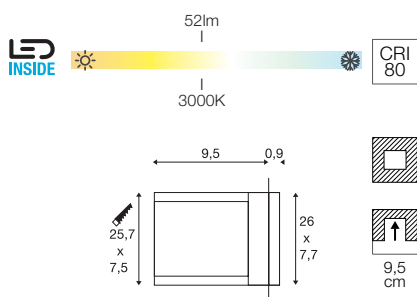
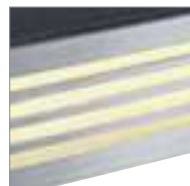

IP 54 L70B50

100-240V ~50/60Hz | 24V
Systemleistung: 3.3W
Material: Edelstahl 316 / Glas

- Einbautopf inkl.

BRICK
EL, symmetrisch

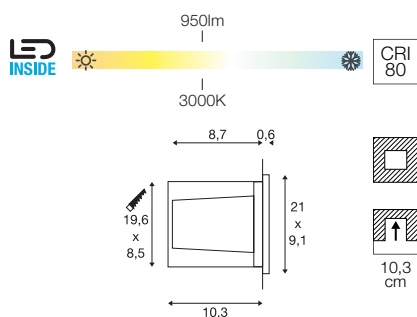
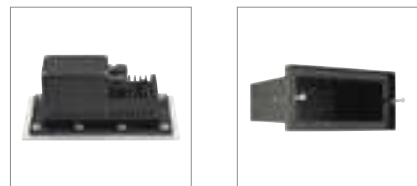

IP 65 IK02 40° L70B50

220-240V ~50/60Hz | 700mA
Systemleistung: 11W
Material: Aluminium / Edelstahl 316

- Einbautopf inkl.

BRICK
EL, asymmetrisch

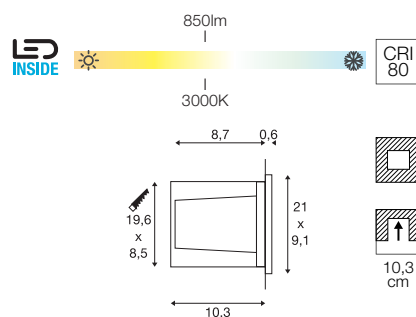
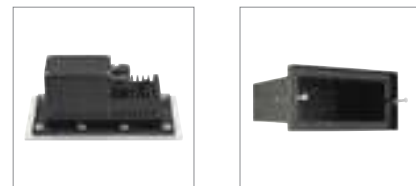

IP 65 IK02 L70B50

220-240V ~50/60Hz | 700mA
Systemleistung: 11W
Material: Aluminium / Edelstahl 316

- Einbautopf inkl.

229110	52lm 3000K	

233650	950lm 3000K	

233660	850lm 3000K	

Variante	Art. Nr.
52lm 3000K CRI80 ■ edelstahl	229110

Variante	Art. Nr.
950lm 3000K CRI80 ■ edelstahl	233650

Variante	Art. Nr.
850lm 3000K CRI80 ■ edelstahl	233660



233650 702



233660 702



229702 703

BRICK DOWNUNDER
EL, E14



SOCKET INSIDE <40 W

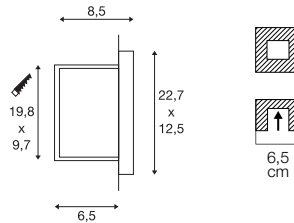

220-240V ~50/60Hz
Material: Aluminium / Glas

- Kein Einbautopf erforderlich



E14 <40W
Ø: 4,3 cm L: 12 cm



LED E14 | 4,2W | 320°
2700K | 370lm | EEK=F
5kWh/1000h



Art. Nr. 1005284

Variante	Art. Nr.
1xE14	
■ grau	229062

BRICK DOWNUNDER
EL



LED INSIDE 30lm | 3000K | CRI 80

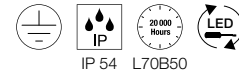
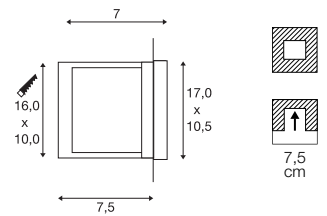

220-240V ~50/60Hz
Systemleistung: 1.4W
Material: Aluminium / Glas

- Einbautopf inkl.



		A → G
229702	30lm 3000K	A ↑ G ↓ F

Variante	Art. Nr.
30lm 3000K CRI80	
■ grau	229702

DECKENEINBAULEUCHTEN



114421 742



PATTA-I
EL, rund, PHASE

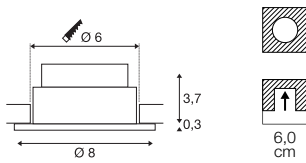
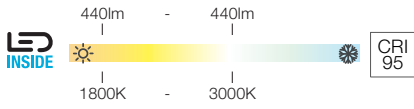

220-240V ~50/60Hz | 350mA
Systemleistung: 7,3W
Material: Aluminium / Glas

- Produkte werden mit Clipfedern geliefert. Blattfedern liegen dem Produkt bei und können ausgetauscht werden.
- Materialstärke 20 mm max.

PATTA-I
DL, eckig, PHASE

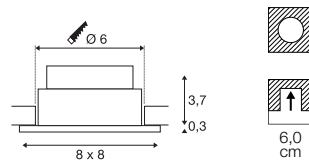
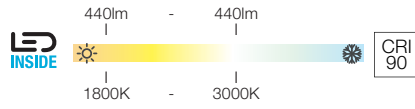

220-240V ~50/60Hz | 350mA
Systemleistung: 7,3W
Material: Aluminium / Glas

- Produkte werden mit Clipfedern geliefert. Blattfedern liegen dem Produkt bei und können ausgetauscht werden.
- Materialstärke 20 mm max.

1002098, 1002099, 1002100	440lm 1800-3000K	

1002101, 1002102, 1002103	440lm 1800-3000K	

Variante	Art. Nr.
440lm 1800-3000K CRI95	
■ schwarz	1002098
440lm 1800-3000K CRI95	
□ weiß	1002099
440lm 1800-3000K CRI95	
▒ gebürstet aluminium	1002100

Variante	Art. Nr.
440lm 1800-3000K CRI90	
■ schwarz	1002101
440lm 1800-3000K CRI95	
□ weiß	1002102
440lm 1800-3000K CRI95	
▒ gebürstet aluminium	1002103



114421 707



1002100 706



PATTA-I
EL, rund, PHASE

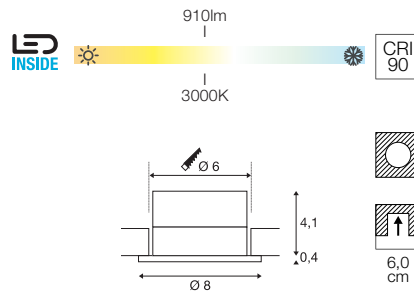

IP 20 / IP 65 38° L70B50

220-240V ~50/60Hz | 500mA
Systemleistung: 11W
Material: Aluminium / Glas

- Materialstärke 20 mm max.

114420, 114421, 114426	910lm 3000K	

Variante	Art. Nr.
910lm 3000K CRI90	
■ schwarz	114420
910lm 3000K CRI80	
□ weiß	114421
910lm 3000K CRI80	
▒ gebürstet aluminium	114426

PATTA-I
EL, quadratisch, PHASE

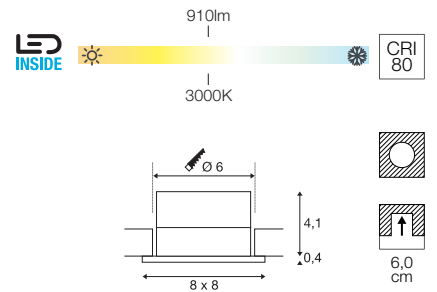

IP 20 / IP 65 38° L70B50

220-240V ~50/60Hz | 500mA
Systemleistung: 11W
Material: Aluminium / Glas

- Materialstärke 20 mm max.

114430, 114431, 114436	910lm 3000K	

Variante	Art. Nr.
910lm 3000K CRI80	
■ schwarz	114430
910lm 3000K CRI80	
□ weiß	114431
910lm 3000K CRI80	
▒ gebürstet aluminium	114436

PATTA-F
EL, rund, PHASE

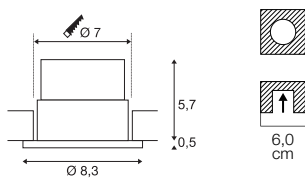
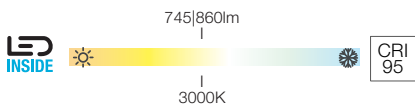

220-240V ~50/60Hz | 500mA
Systemleistung: 11W
Material: Aluminium / Glas

- Materialstärke 20 mm max.

PATTA-F
EL, quadratisch, PHASE

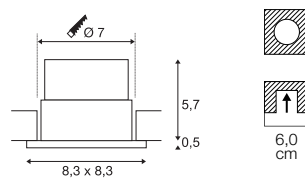
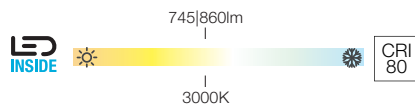

220-240V ~50/60Hz | 500mA
Systemleistung: 11W
Material: Aluminium / Glas

- Produkte werden mit Clipfedern geliefert. Blattfedern liegen dem Produkt bei und können ausgetauscht werden.
- Materialstärke 20 mm max.

OUT 65
EL, rund, PHASE

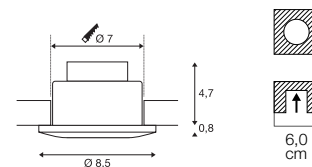
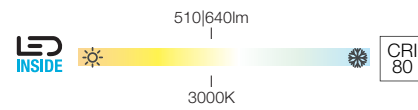

220-240V ~50/60Hz | 500mA
Systemleistung: 11W
Material: Aluminium / Glas

- Produkte werden mit Clipfedern geliefert. Blattfedern liegen dem Produkt bei und können ausgetauscht werden.
- Materialstärke 20 mm max.

114440, 114441	745lm 860lm 3000K	

Variante	Art. Nr.
745lm 3000K CRI95	
■ schwarz	114440
860lm 3000K CRI80	
□ weiß	114441

114450, 114451	745lm 860lm 3000K	

Variante	Art. Nr.
745lm 3000K CRI80	
■ schwarz	114450
860lm 3000K CRI80	
□ weiß	114451

114460, 114461	510lm 640lm 3000K	

Variante	Art. Nr.
510lm 3000K CRI80	
■ schwarz / matt	114460
640lm 3000K CRI80	
□ weiß / matt	114461

KINI
EL, PHASE

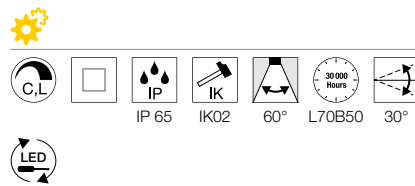
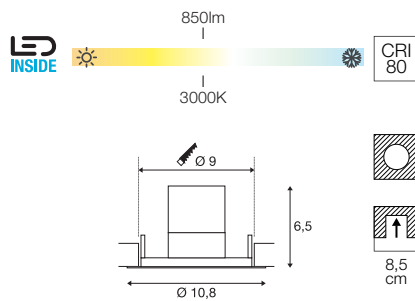

220-240V ~50/60Hz | 260mA
Systemleistung: 12W
Material: Aluminium / Polycarbonat (PC)

- Materialstärke Einbaufäche: 5 -20 mm

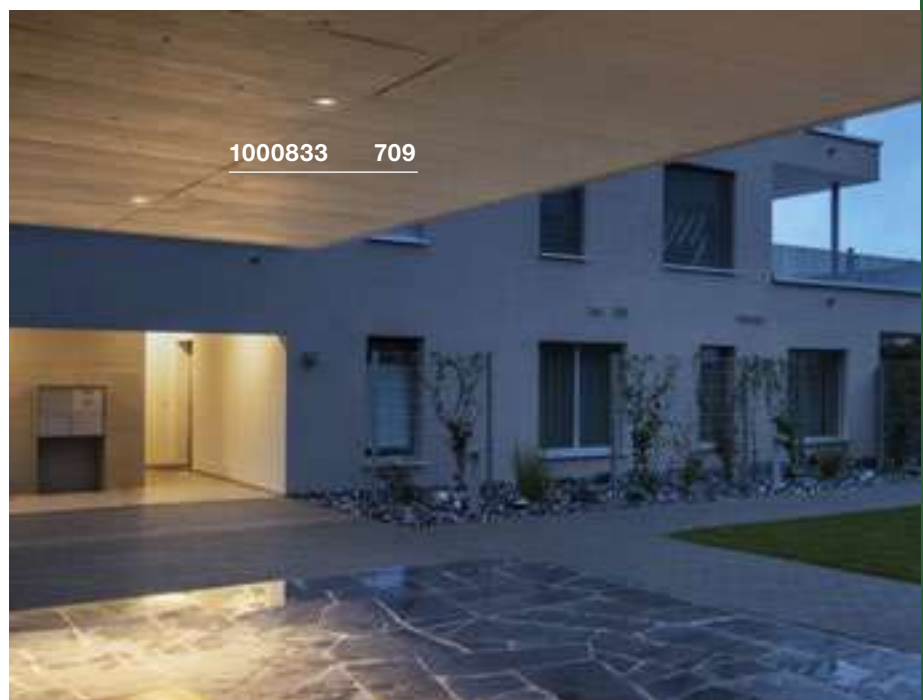

1000833	850lm 3000K	

Variante	Art. Nr.
850lm 3000K CRI80 □ weiß	1000833

KAMUELA ECO
EL, rund, PHASE

KAMUELA ECO
EL, rund, PHASE

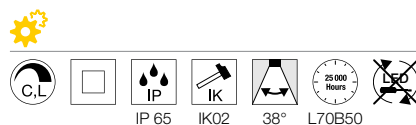
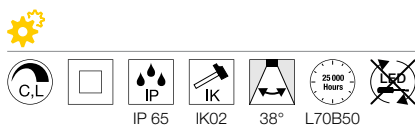
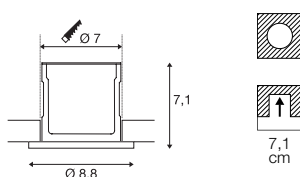
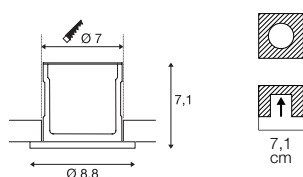
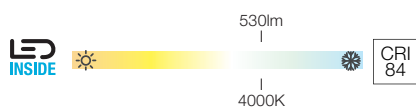

220-240V ~50Hz
Systemleistung: 6W
Material: Aluminium / Kunststoff

220-240V ~50Hz
Systemleistung: 6W
Material: Aluminium / Kunststoff

• Materialstärke Einbaufäche: 40 mm max.

• Materialstärke Einbaufäche: 40 mm max.

1001015, 1001016	500lm 3000K	

1001017, 1001018	530lm 4000K	

Variante	Art. Nr.
500lm 3000K CRI84	
■ schwarz	1001015
500lm 3000K CRI84	
□ weiß	1001016

Variante	Art. Nr.
530lm 4000K CRI84	
■ schwarz	1001017
530lm 4000K CRI84	
□ weiß	1001018





1001165 713





1001167 713

DOLIX OUT
EL, rund, QPAR51

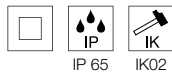
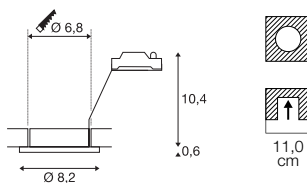

220-240V ~50/60Hz
Material: Aluminium / Glas

- Materialstärke 20mm max.



GU10 <50W



LED GU10 51mm | 4W | 36°
2700K | 270lm | EEK=G
4kWh/1000h

Art. Nr. 1004972

DOLIX OUT
EL, quadratisch, QPAR51

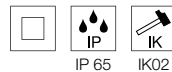
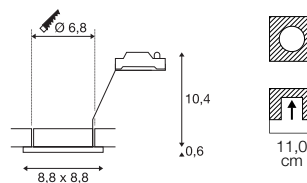
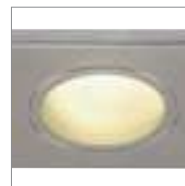

220-240V ~50/60Hz
Material: Aluminium / Glas

- Materialstärke 20mm max.



GU10 <50W



LED GU10 51mm | 4W | 36°
3000K | 270lm | EEK=G
4kWh/1000h

Art. Nr. 1004973

Variante	Art. Nr.
1xGU10	
weiß	1001165
1xGU10	
chrom	1001166
1xGU10	
grau	1001167
1xGU10	
silber	1001168

Variante	Art. Nr.
1xGU10	
weiß	1001169
1xGU10	
chrom	1001170
1xGU10	
grau	1001171
1xGU10	
silber	1001172

BODENEINBAULEUCHTEN



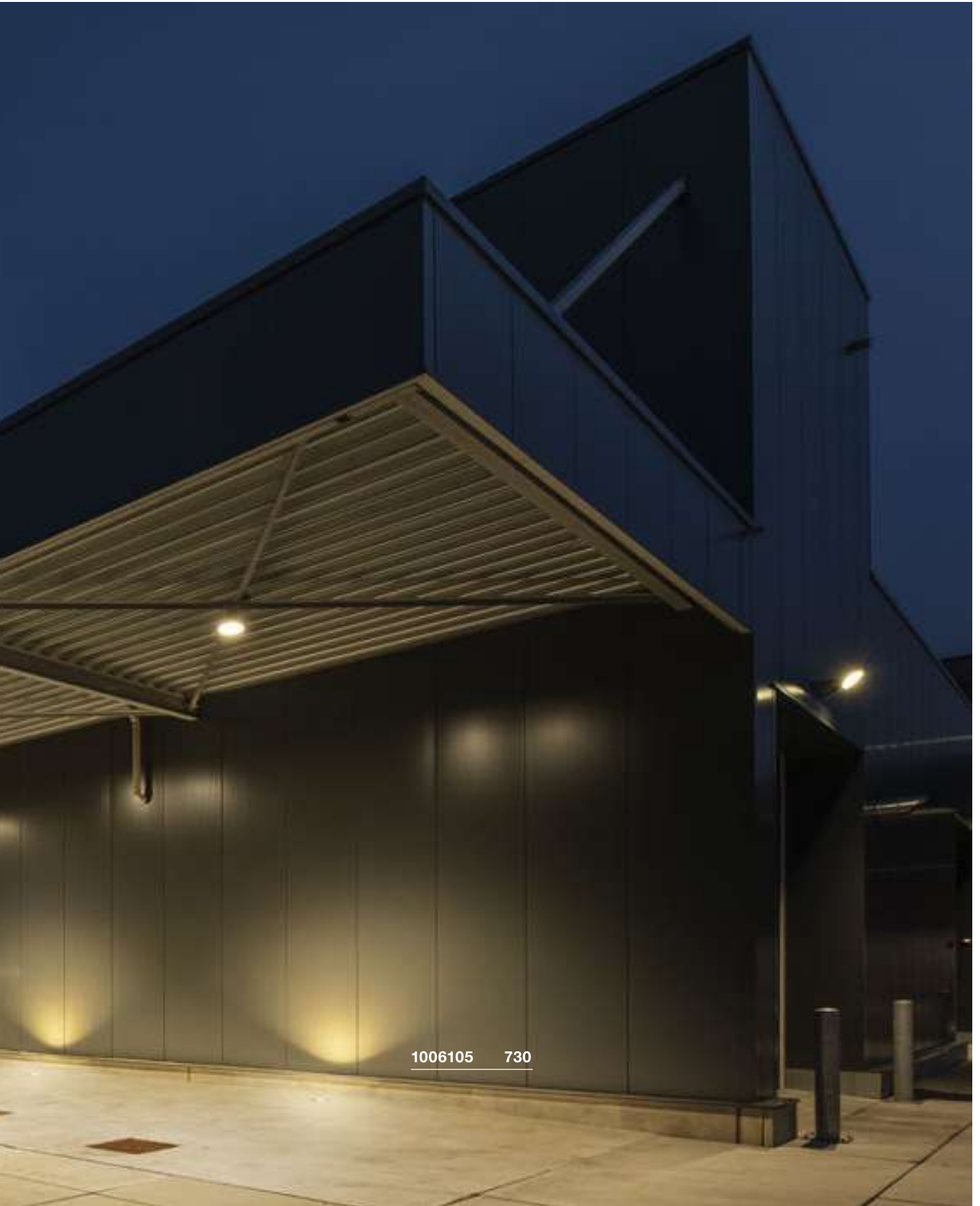

1006105 730

DASAR® FLAT 80
EL

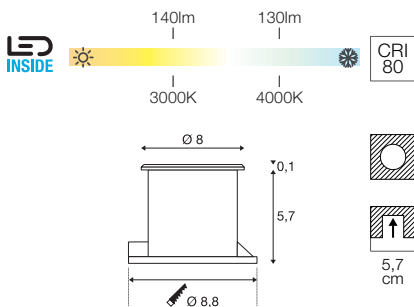

IP 65 / IP 67 | IK08 | 125° | L70B50 | 150 | 0.5 t

220-240V ~50/60Hz
Systemleistung: 3.5W
Material: Edelstahl 304 / Glas

- Einbautopf inkl.
- Die Leuchte ist für den Einbau in Holz geeignet
- Offenes Kabelende

228412, 1002188	140lm 130lm 3000K 4000K	

■ Verbindungsbox IP68, 3-polig
Art. Nr. 228730

Variante	Art. Nr.
140lm 3000K CRI80 ■ edelstahl	228412
130lm 4000K CRI80 ■ edelstahl	1002188

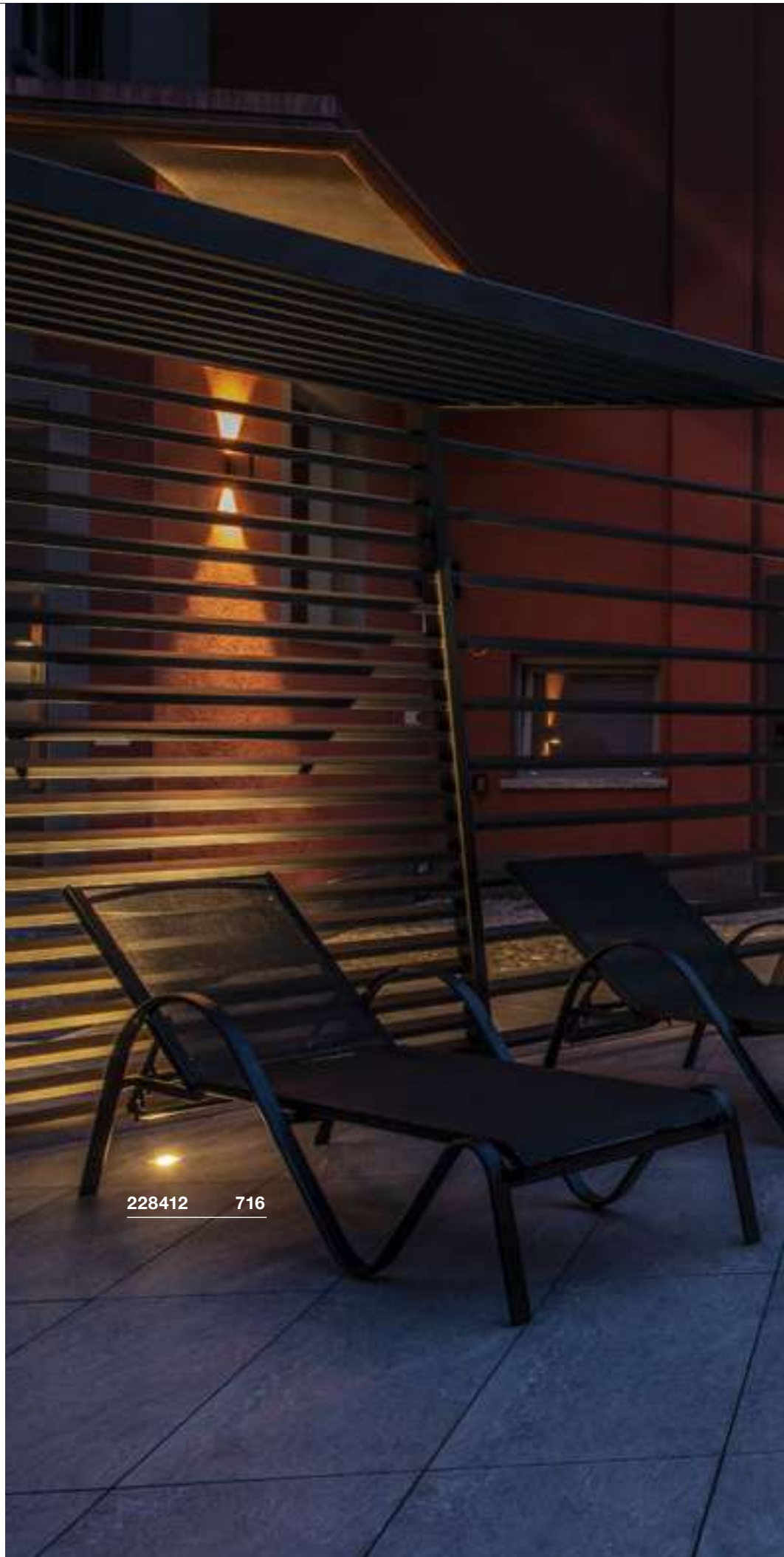

228412 716



1006106 717



1006106 717

DASAR® FLAT 120 EL

NEW

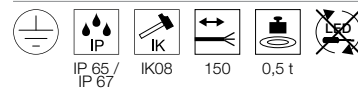
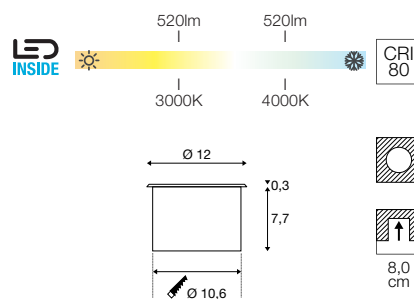

220-240V ~50/60Hz | 350mA
 Systemleistung: 7W
 Material: Edelstahl 304

- Offenes Kabelende



		A → G
1006106, 1006107	520lm 3000K 4000K	A F G D

Variante	Art. Nr.
520lm 3000K CRI80 edelstahl	1006106
520lm 4000K CRI80 edelstahl	1006107

DASAR® 255
EL

DASAR® 920
EL

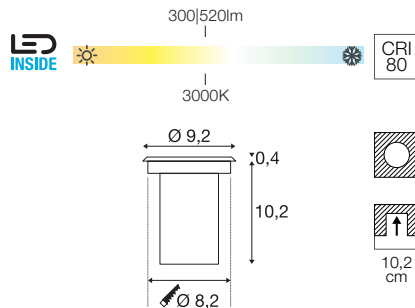
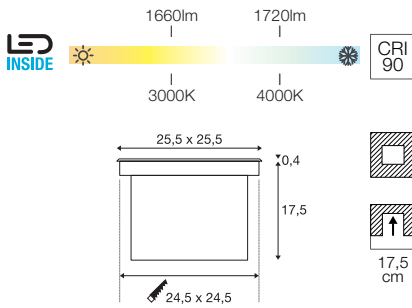

220-240V ~50/60Hz | 750mA
Systemleistung: 31W
Material: Edelstahl 316 / Glas

- Einbautopf inkl.

12-24V
Systemleistung: 6.5W
Material: Edelstahl 316 / Glas

- Einbautopf inkl.
- Offenes Kabelende

229383, 229381	1660lm 1720lm 3000K 4000K	

233500	520lm 3000K	

Variante	Art. Nr.
1660lm 3000K CRI90 ■ edelstahl	229383
1720lm 4000K CRI90 ■ edelstahl	229381

Variante	Art. Nr.
520lm 3000K CRI80 ■ edelstahl	233500





1002893 719

DASAR® 270
EL, asymmetrisch

DASAR® 270
EL, symmetrisch

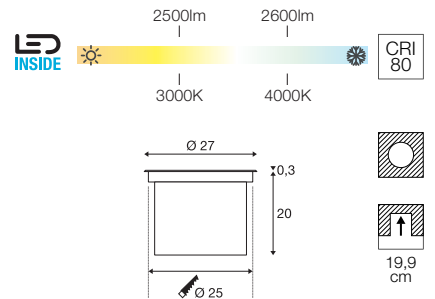
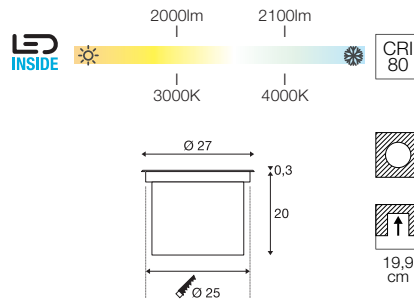

IP 65 / IP 67 IK08 L70B50 60 2 t

IP 65 / IP 67 IK08 38° L70B50 30° 60 2 t

220-240V ~50/60Hz | 700mA
Systemleistung: 30W
Material: Aluminium / Edelstahl 316

220-240V ~50/60Hz | 700mA
Systemleistung: 30W
Material: Aluminium / Edelstahl 316

1002893, 1002895	2000lm 2100lm 3000K 4000K	

1002897, 1002898	2500lm 2600lm 3000K 4000K	



DASAR® 270 |
Honeycomb Abdeckung
Art. Nr. 1002899

Variante	Art. Nr.
2000lm 3000K CRI80 ■ edelstahl	1002893
2100lm 4000K CRI80 ■ edelstahl	1002895

Variante	Art. Nr.
2500lm 3000K CRI80 ■ edelstahl	1002897
2600lm 4000K CRI80 ■ edelstahl	1002898



229320 721



229320 721



229374 721

DASAR® 80
EL, rund/quadratisch, QPAR51

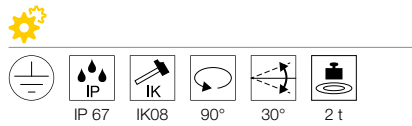
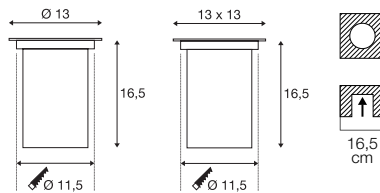

220-240V ~50/60Hz
Material: Edelstahl 316 / Glas

- Einbautopf inkl.

DASAR® 70
EL, quadratisch, QPAR51

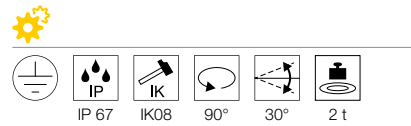
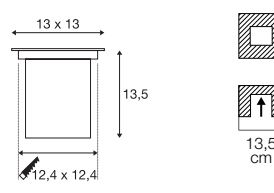

220-240V ~50/60Hz
Material: Edelstahl 316 / Glas

- Einbautopf inkl.

DASAR® EXACT 116
EL, rund/quadratisch, QPAR51

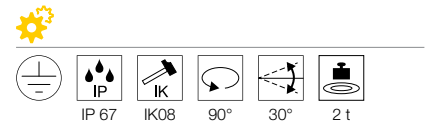
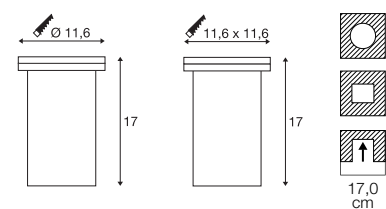

220-240V ~50/60Hz
Material: Edelstahl 316 / Glas

- Einbautopf inkl.

GU10 <35W
Ø: 5 cm L: 6 cm

LED GU10 51mm | 4W | 36°
2700K | 270lm | EEK=G
4kWh/1000h

Art. Nr. 1004972

Variante	Art. Nr.
1xGU10	
edelstahl	229320
1xGU10	
edelstahl	229324

GU10 <35W
Ø: 5 cm L: 6 cm

LED GU10 51mm | 4W | 36°
2700K | 270lm | EEK=G
4kWh/1000h

Art. Nr. 1004972

Variante	Art. Nr.
1xGU10	
edelstahl	229374

GU10 <35W
Ø: 5 cm L: 6 cm

LED GU10 51mm | 6W | 38°
3000K | 470lm | EEK=F
6kWh/1000h

Art. Nr. 1005079

Variante	Art. Nr.
1xGU10	
edelstahl	228430
1xGU10	
edelstahl	228434

DASAR® 215
EL, rund/quadratisch, QPAR111



SOCKET INSIDE <75 W

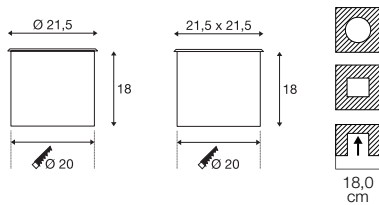

220-240V - 50/60Hz
Material: Edelstahl 316 / Glas

- Einbautopf inkl.

DASAR® 215
EL, rund, E27



SOCKET INSIDE <11 W

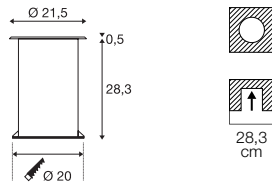

220-240V - 50/60Hz
Material: Edelstahl 316 / Glas

- Oberflächentemperatur: Energysaver = 48°C/
PAR 30 = 119°C/ PAR 38 = 108°C
- Einbautopf inkl.

DASAR® 218
EL, QR111



SOCKET INSIDE <50 W

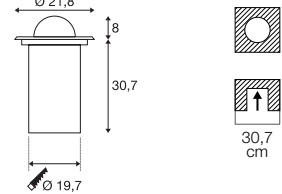

220-240V - 50/60Hz / 12V
Material: Edelstahl 316 / Glas

- Einbautopf inkl.

GU10 <75W

LED QPAR111 | 12,5W | 30°
4000K | 1090lm | EEK=F
13kWh/1000h

Art. Nr. 1005282

Variante	Art. Nr.
1xGU10	
edelstahl	229230
1xGU10	
edelstahl	229234

E27 <11W
Ø: 4,5 cm L: 13,4 cm

LED E27 | 8W | 240°
3000K | 870lm | EEK=E
8kWh/1000h

Art. Nr. 1005289

Variante	Art. Nr.
1xE27	
edelstahl	229200

G53 <50W

LED G53 | 15W | 24°
2700K | 760lm | EEK=G
17kWh/1000h

Art. Nr. 560231

Variante	Art. Nr.
1xG53	
edelstahl	228370



228370 722



229234 723



233540 723

DASAR® 370
EL, rund

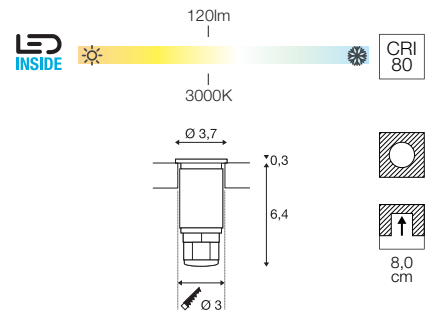

12-24V
Leistungsaufnahme: 2W
Material: Edelstahl 316 / Glas

- Die Leuchte ist für den Einbau in Holz geeignet
- Offenes Kabelende



		A → G
233540	120lm 3000K	A G F

Variante	Art. Nr.
120lm 3000K CRI80 ■ edelstahl	233540

TRAIL-LITE® 60
EL

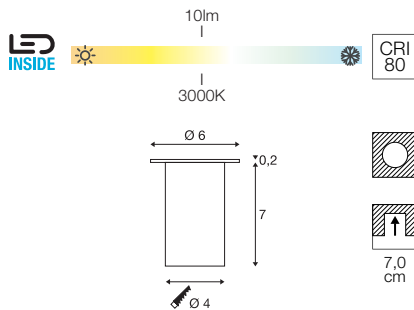

12V ~50/60Hz
Leistungsaufnahme: 0,3 W
Material: Edelstahl 316 / Glas

- Betrieb nur mit konventionellem Trafo.
- Einbaukopf inkl.
- Die Leuchte ist für den Einbau in Holz geeignet

POWER TRAIL-LITE®
EL, rund/quadratisch

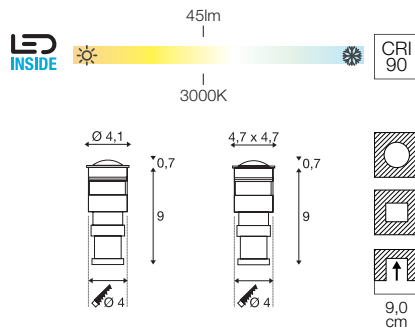

350mA
Systemleistung: 1W
Material: Edelstahl 316 / Glas

- Betrieb nur mit Treiber 350mA. Verdrahtung von mehreren PowerLEDs nur in Reihenschaltung!
- Einbauhülse inkl.
- Die Leuchte ist für den Einbau in Holz geeignet
- Offenes Kabelende

228332, 228342	45lm 3000K	

LED Treiber 320mA | 3W
inkl. Zugentlastung
Art. Nr. 464108

Transformator 12V AC | 10VA IP44
Art. Nr. 227140

Variante	Art. Nr.
10lm 3000K CRI80 ■ edelstahl	227462

Variante	Art. Nr.
45lm 3000K CRI90 ○ ■ edelstahl	228332
45lm 3000K CRI90 □ ■ edelstahl	228342

GIMBLE OUT
EL

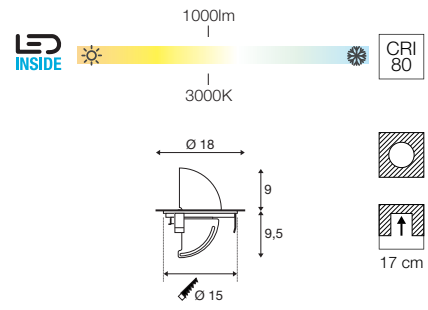

220-240V ~50/60Hz | 600mA
Systemleistung: 13W
Material: Edelstahl 316 / Glas

- Offenes Kabelende

1000384	1000lm 3000K	

Verbindungsbox IP68, 3-polig
Art. Nr. 228730
 Einbaurohr DN160
Art. Nr. 233792
 Bodeneinbautopf
Art. Nr. 1000655

Variante	Art. Nr.
1000lm 3000K CRI80 ■ edelstahl	1000384

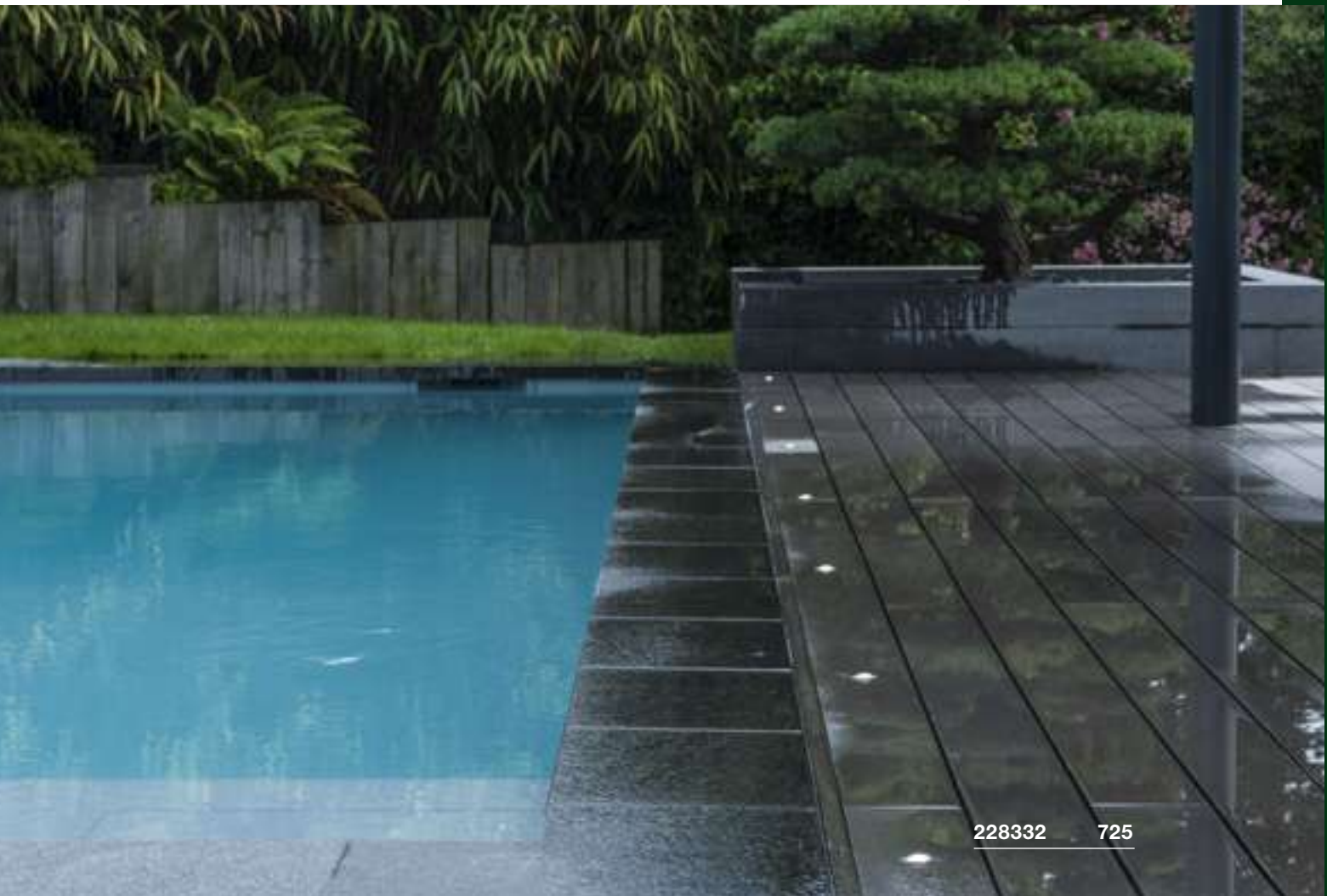



1006171 + 1006173 727

SMALL PLOT
Abdeckung, 2er

NEW



Material 1006173: Edelstahl316
Material 1006174: Aluminium

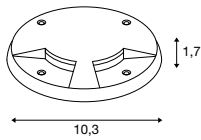

Variante	Art. Nr.
edelstahl	1006173
anthrazit	1006174

SMALL PLOT
Abdeckung, 4er

NEW



Material 1006175: Edelstahl316
Material 1006176: Aluminium

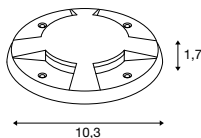

Variante	Art. Nr.
edelstahl	1006175
anthrazit	1006176

SMALL PLOT
Module

NEW

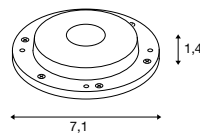

24V DC
Leistungsaufnahme: 3W
Material: Aluminium/Polymethylacrylat (PMMA)

- Offenes Kabelende



1006172	240lm 3000K	A → G F
---------	----------------	------------

Variante	Art. Nr.
240lm 3000K CRI80 aluminium	1006172

SMALL PLOT
Module

NEW

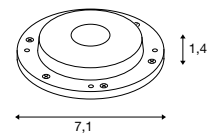
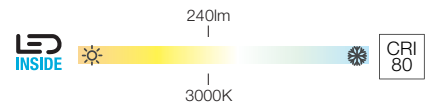

24V DC
Leistungsaufnahme: 3W
Material: Edelstahl316/Polymethylacrylat (PMMA)

- Offenes Kabelende



1006171	240lm 3000K	A → G F
---------	----------------	------------

Variante	Art. Nr.
240lm 3000K CRI80 edelstahl	1006171

BIG PLOT
Module



460lm
3000K

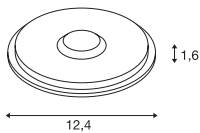
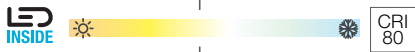

BIG PLOT
Module



460lm
3000K

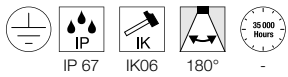
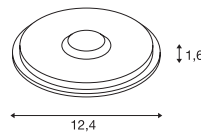
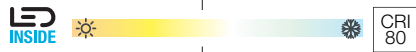

220-240V ~50/60Hz | 16mA
Systemleistung: 5,5W
Material: Aluminium/Polymethylacrylat (PMMA)

- Offenes Kabelende
- Produkt wird ohne Cover geliefert.
Passende Cover finden Sie auf Seite 728.



220-240V ~50/60Hz | 16mA
Systemleistung: 5,5W
Material: Edelstahl316/Polymethylacrylat (PMMA)

- Offenes Kabelende
- Produkt wird ohne Cover geliefert.
Passende Cover finden Sie auf Seite 728.



Die Informationen zur Energieeffizienzklasse für dieses Produkt lagen bei Druck noch nicht vor. Die aktuellsten Produktdaten finden Sie jederzeit unter www.slv.com



Die Informationen zur Energieeffizienzklasse für dieses Produkt lagen bei Druck noch nicht vor. Die aktuellsten Produktdaten finden Sie jederzeit unter www.slv.com



■ Verbindungsbox IP68, 3-polig
Art. Nr. 228730



■ Verbindungsbox IP68, 3-polig
Art. Nr. 228730



Variante	Art. Nr.
460lm 3000K CRI80	
■ aluminium	1001256

Variante	Art. Nr.
460lm 3000K CRI80	
■ edelstahl	1001359

BIG PLOT
Abdeckung, 2er



Material 1001254: Edelstahl316
Material 1001252/1001262: Aluminium

1001254 bis 0,8t belastbar
1001252 bis 0,5t belastbar
1001262 bis 0,5t belastbar

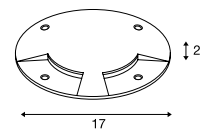

Variante	Art. Nr.
■ edelstahl	1001254
■ grau	1001252
■ anthrazit	1001262

BIG PLOT
Abdeckung, 4er



Material 1001255: Edelstahl316
Material 1001253/1001263: Aluminium

1001255 bis 0,8t belastbar
1001253 bis 0,5t belastbar
1001263 bis 0,5t belastbar

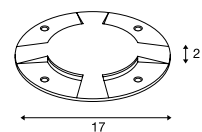

Variante	Art. Nr.
■ edelstahl	1001255
■ grau	1001253
■ anthrazit	1001263

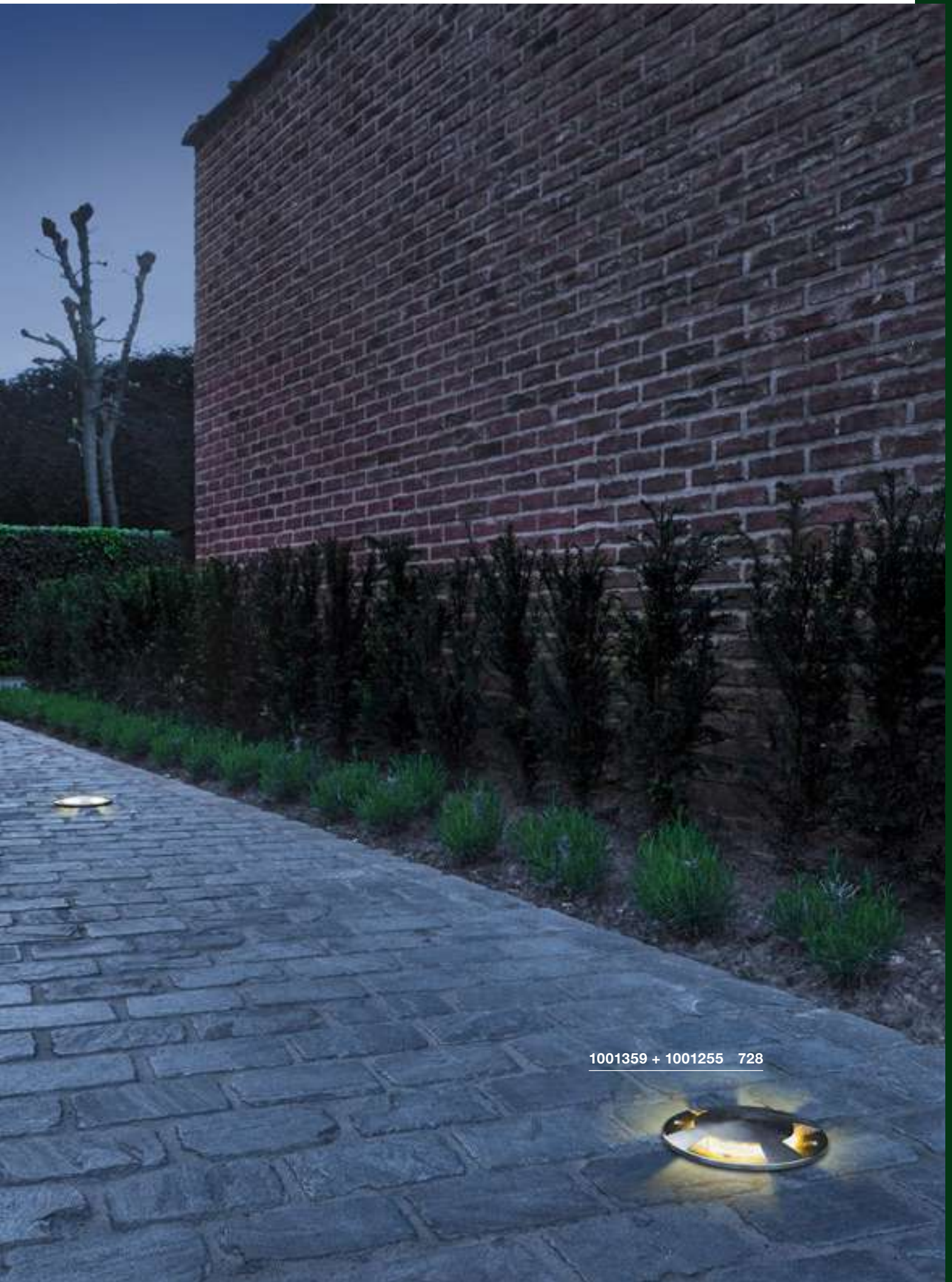

1001359 + 1001255 728

ROCCI
EL, rund

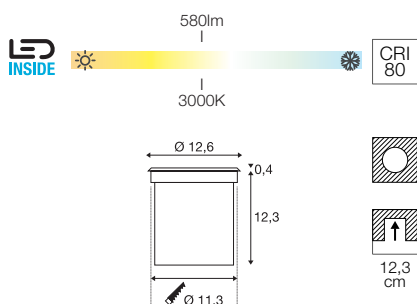

100-277V ~50/60Hz | 700mA
Systemleistung: 8.6W
Material: Edelstahl 316 / Glas

- Einbautopf inkl.

ROCCI
EL, quadratisch

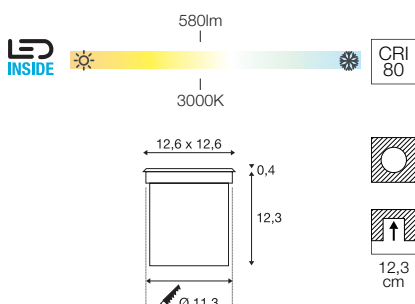

100-277V ~50/60Hz | 700mA
Systemleistung: 8.6W
Material: Edelstahl 316 / Glas

- Einbautopf inkl.

ROCCI 200
EL, rund/quadratisch

NEW

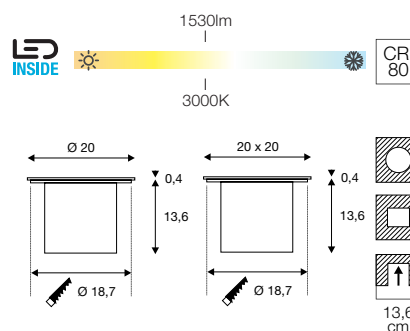

100-277V ~50/60Hz | 350mA
Systemleistung: 16W
Material: Stahl

- Einbautopf inkl.

227600	580lm 3000K	

Variante	Art. Nr.
580lm 3000K CRI80 ■ edelstahl	227600

227604	580lm 3000K	

Variante	Art. Nr.
580lm 3000K CRI80 ■ edelstahl	227604

1006104 1006105	1530lm 3000K	



Variante	Art. Nr.
1530lm 3000K CRI80 ○ edelstahl	1006104 ■
1530lm 3000K CRI80 ■ edelstahl	1006105 ■

LED-PROFILE

ÜBERSICHT



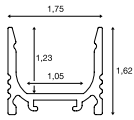
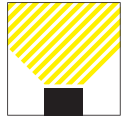

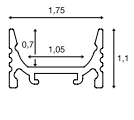
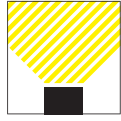
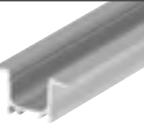
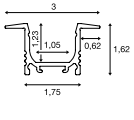
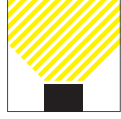
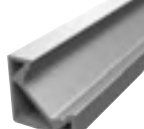
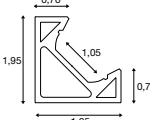
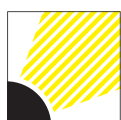
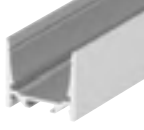
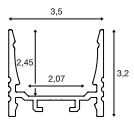
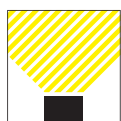
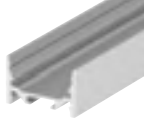
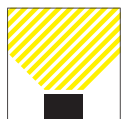
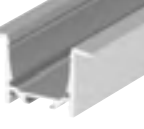
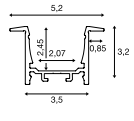
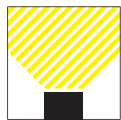
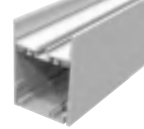
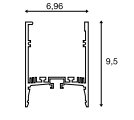
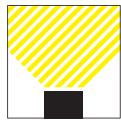
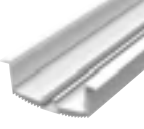
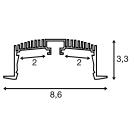
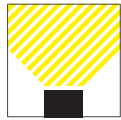
LED-Profil	Montageart			Querschnitt	Abstrahlwinkel	Seite		
	Aufbau	Einbau	Pendel					
GRAZIA 10	Standard		✓	-	-			735
	Flach		✓	-	-			735
	Einbau		-	✓	-			735
GRAZIA 10 EDGE	Aufbau		✓	-	-			738
GRAZIA 20	Standard		✓	-	✓			741
	Flach		✓	-	✓			741
	Einbau		-	✓	-			742
GRAZIA 60	Aufbau		✓	-	-			747
	Einbau		-	✓	-			747



Passende LED-Stripes und Komponenten finden Sie ab Seite 750 und das passende Zubehör (Netzteile, Treiber, etc.) ab Seite 795

GRAZIA 10

AUF- UND EINBAUPROFIL

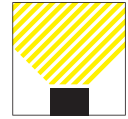

AUFBAUPROFIL, FLACH

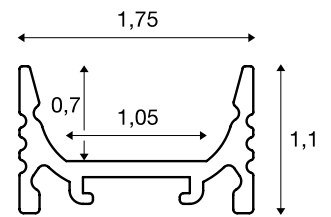

Aufbauprofil, Flach, aluminium, weiß, schwarz

Länge	Farbe	Material	Art. Nr.
200 cm	<input type="checkbox"/> aluminium	Aluminium	1000460
	<input type="checkbox"/> weiß		1000461
	<input type="checkbox"/> schwarz		1000462

Breite/Höhe: 1,75/1,1 cm, max. Breite LED-Strip: 1,0 cm, Abdeckung exkl.

AUFBAUPROFIL, STANDARD

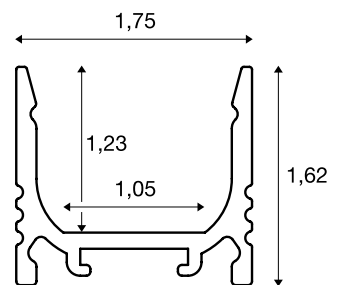
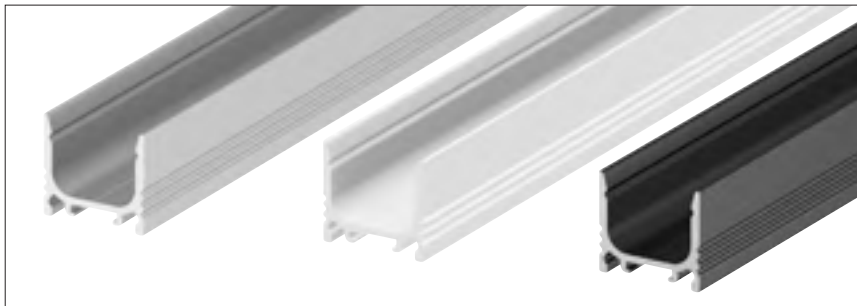

Aufbauprofil, Standard, aluminium, weiß, schwarz

Länge	Farbe	Material	Art. Nr.
200 cm	<input type="checkbox"/> aluminium	Aluminium	1000463
	<input type="checkbox"/> weiß		1000464
	<input type="checkbox"/> schwarz		1000465

Breite/Höhe: 1,75/1,62 cm, max. Breite LED-Strip: 1,0 cm, Abdeckung exkl.

EINBAUPROFIL

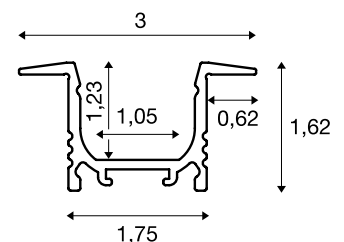
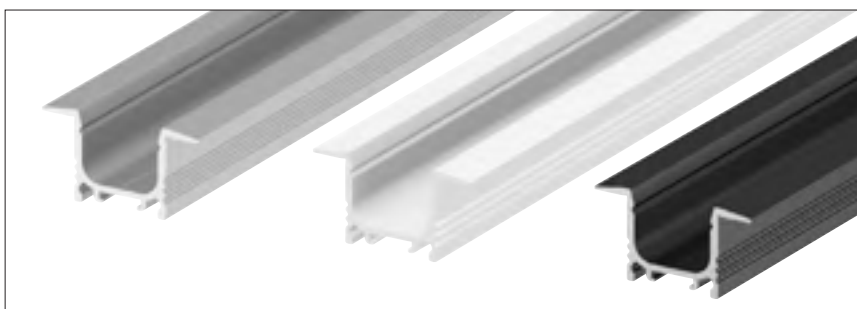

Einbauprofil, alu eloxiert, weiß, schwarz

Länge	Farbe	Material	Art. Nr.
200 cm	<input type="checkbox"/> aluminium	Aluminium	1000457
	<input type="checkbox"/> weiß		1000458
	<input type="checkbox"/> schwarz		1000459

Breite/Höhe: 3,0/1,62 cm, max. Breite LED-Strip: 1,0 cm, Abdeckung exkl.

GRAZIA 10

ZUBEHÖR

ABDECKUNGEN



flach, gefroret



flach, milchig



flach, transparent

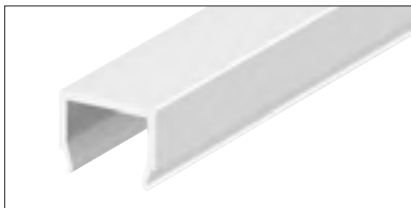

hoch, milchig (nur für Aufbauprofile geeignet)

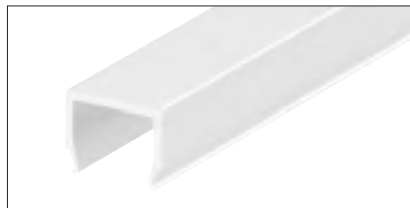

hoch, gefroret (nur für Aufbauprofile geeignet)

Länge	Farbe	Material	Art. Nr.
200 cm	<input type="checkbox"/> flach, gefroret	Kunststoff PC	1000466
	<input type="checkbox"/> flach, milchig	Kunststoff PMMA	1000468
	<input type="checkbox"/> flach, transparent	Kunststoff PC	1000467
	<input type="checkbox"/> flach, gefroret	Kunststoff PMMA	1000469
	<input type="checkbox"/> hoch, milchig*	Kunststoff PC	1000470
	<input type="checkbox"/> hoch, gefroret*	Kunststoff PMMA	1000471

Kunststoff PMMA/PC:

Profil-Abdeckungen aus PMMA sind besonders homogen.

Profil-Abdeckungen aus PC sind bruchstark und eignen sich sehr gut für Anwendungen mit hohem Anspruch an die Widerstandsfähigkeit.

* Die hohen Abdeckungen sind nur für GRAZIA 10 Aufbauprofile geeignet, nicht für die Einbauprofile.

MONTAGECLIPS



Montageclip, nicht sichtbar



Montageclip, 45°

Beschreibung	Maße	Art. Nr.
Montageclip, nicht sichtbar	B/H/T: 1,53/0,3/1 cm	1000487
Montageclip, 45°	B/H/T: 1,62/1,62/1 cm	1000489

Material: Edelstahl, Verpackungseinheit: 2 Stück

ENDKAPPEN FÜR AUFBAUPROFILE

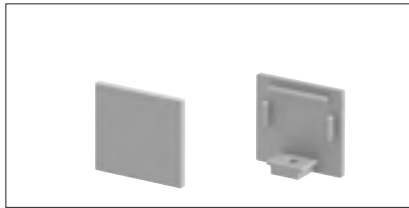

für Profil Standard, Abdeckung flach

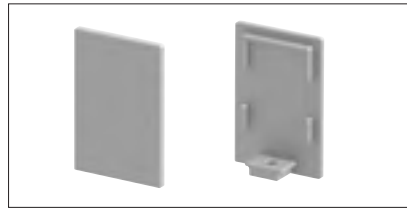

für Profil Standard, Abdeckung hoch

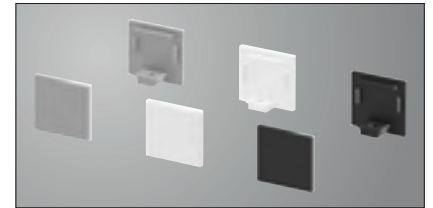

erhältliche Farbvarianten

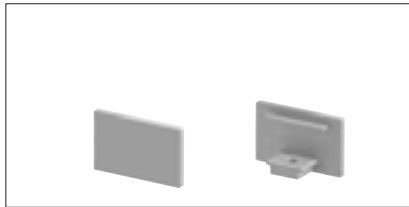

für Profil flach, Abdeckung flach

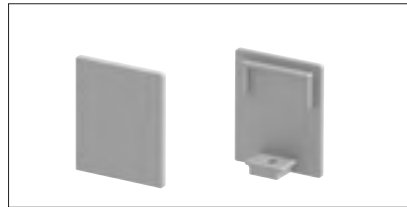

für Profil flach, Abdeckung hoch

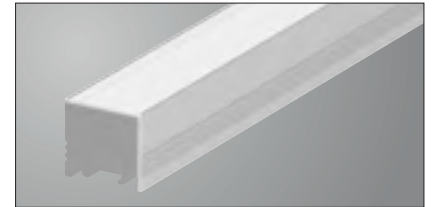

Profil mit montierter Endkappe

Beschreibung	Farbe	sichtbare Tiefe	Art. Nr.
Endkappe für Profil flach, Abdeckung flach	aluminium	0,2 cm	1000475
	weiß		1000476
	schwarz		1000477
Endkappe für Profil flach, Abdeckung hoch	aluminium	0,2 cm	1000481
	weiß		1000482
	schwarz		1000483
Endkappe für Profil Standard, Abdeckung flach	aluminium	0,2 cm	1000478
	weiß		1000479
	schwarz		1000480
Endkappe für Profil Standard, Abdeckung hoch	aluminium	0,2 cm	1000484
	weiß		1000485
	schwarz		1000486

Material: Aluminium, Verpackungseinheit: 2 Stück

ENDKAPPEN FÜR EINBAUPROFIL



für Einbauprofil

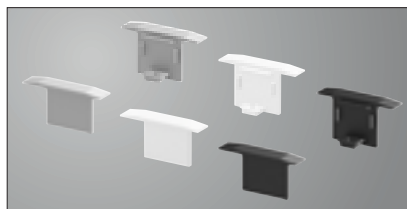

erhältliche Farbvarianten

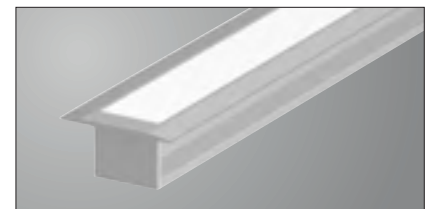

Profil mit montierter Endkappe

Beschreibung	Farbe	sichtbare Tiefe	Art. Nr.
Endkappe für Einbauprofil	aluminium	0,7 cm	1000472
	weiß		1000473
	schwarz		1000474

Material: Aluminium, Verpackungseinheit: 2 Stück



Bitte beachten Sie, dass bei der Verwendung von Endkappen die sichtbare Tiefe von der Profillänge abgezogen werden muss, um die gewünschte Gesamtlänge zu erhalten.

sichtbare Tiefe Endkappen + Profillänge = Gesamtlänge

GRAZIA 10 EDGE

AUFBAUPROFIL

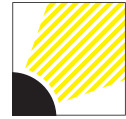

AUFBAUPROFIL



Aufbauprofil, aluminium, weiß

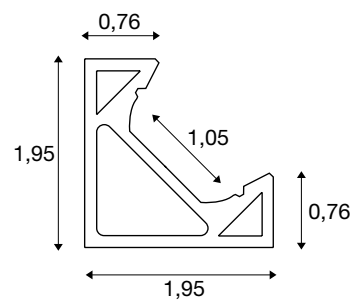

Länge	Farbe	Material	Art. Nr.
200 cm	<input type="checkbox"/> aluminium	Aluminium	1004889
	<input type="checkbox"/> weiß		1004890

Aluminium, Breite/Höhe: 1,95/1,95 cm, max. Breite LED-Strip: 1,0 cm

GRAZIA 10 EDGE

ZUBEHÖR

ABDECKUNGEN



gefrostet, Kunststoff PC



transparent, Kunststoff PC



milchig, Kunststoff PMMA

Länge	Farbe	Material	Art. Nr.
200 cm	<input type="checkbox"/> gefrostet	Kunststoff PC	1000466
	<input type="checkbox"/> transparent	Kunststoff PC	1000467
	<input type="checkbox"/> milchig	Kunststoff PMMA	1000468
	<input type="checkbox"/> gefrostet	Kunststoff PMMA	1000469

Kunststoff PMMA/PC:

Profil-Abdeckungen aus PMMA sind besonders homogen.

Profil-Abdeckungen aus PC sind bruchstark und eignen sich sehr gut für Anwendungen mit hohem Anspruch an die Widerstandsfähigkeit.

ENDKAPPEN

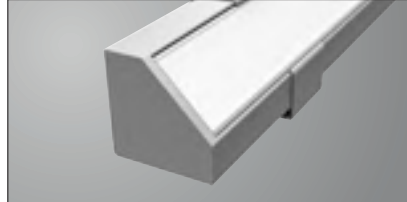
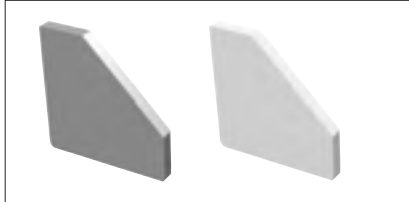

Beschreibung	Farbe	sichtbare Tiefe	Art. Nr.
Endkappen	<input type="checkbox"/> aluminium	2 mm	1004893
	<input type="checkbox"/> weiß	2 mm	1004894

Material: Aluminium, Verpackungseinheit: 2 Stück



Bitte beachten Sie, dass bei der Verwendung von Endkappen die sichtbare Tiefe von der Profillänge abgezogen werden muss, um die gewünschte Gesamtlänge zu erhalten.

sichtbare Tiefe Endkappen + Profillänge = Gesamtlänge

MONTAGECLIPS

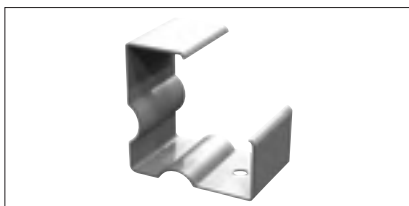

Beschreibung	Farbe	Maße	Art. Nr.
Montageclips	<input checked="" type="checkbox"/> edelstahl	L/B/H: 2,25/15/3,25 cm	1004895

Material: Stahl, Verpackungseinheit: 4 Stück

GRAZIA 20

AUFBAUPROFIL

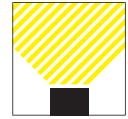

auch als Pendelleuchte verwendbar (Pendelabhängung s. S. 779)



hochwertige pulverbeschichtete Aluminiumoberfläche



erhältliche Farbvarianten: aluminium, weiß, schwarz

GRAZIA 20

AUFBAUPROFIL

STANDARD



glatt



gerillt

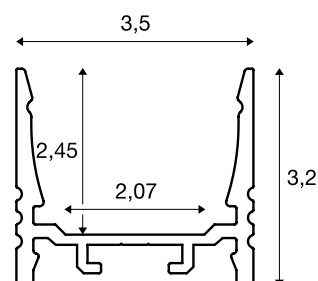

Beschreibung	Länge	Farbe	Material:	Art. Nr.
Standard glatt	150 cm	<input type="checkbox"/> aluminium	Aluminium	1004918
		<input type="checkbox"/> weiß		1004919
		<input type="checkbox"/> schwarz		1004920
	300 cm	<input type="checkbox"/> aluminium		1000523
		<input type="checkbox"/> weiß		1000524
		<input type="checkbox"/> schwarz		1000525
Standard gerillt	300 cm	<input type="checkbox"/> aluminium	1000514	
		<input type="checkbox"/> weiß	1000515	
		<input type="checkbox"/> schwarz	1000516	

Breite/Höhe: 3,5/3,2 cm, max. Breite LED-Strip: 2,0 cm, Abdeckung exkl.

FLACH



glatt



gerillt

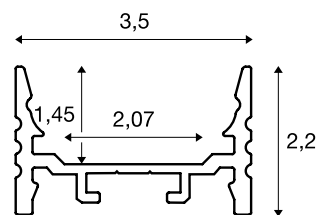

Beschreibung	Länge	Farbe	Material:	Art. Nr.
Flach glatt	150 cm	<input type="checkbox"/> aluminium	Aluminium	1004921
		<input type="checkbox"/> weiß		1004922
		<input type="checkbox"/> schwarz		1004923
	300 cm	<input type="checkbox"/> aluminium		1000532
		<input type="checkbox"/> weiß		1000533
		<input type="checkbox"/> schwarz		1000534
Flach gerillt	300 cm	<input type="checkbox"/> aluminium	1000505	
		<input type="checkbox"/> weiß	1000506	
		<input type="checkbox"/> schwarz	1000507	

Breite/Höhe: 3,5/2,2 cm, max. Breite LED-Strip: 2,0 cm, Abdeckung exkl.

GRAZIA 20

EINBAUPROFIL

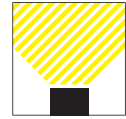

EINBAUPROFIL

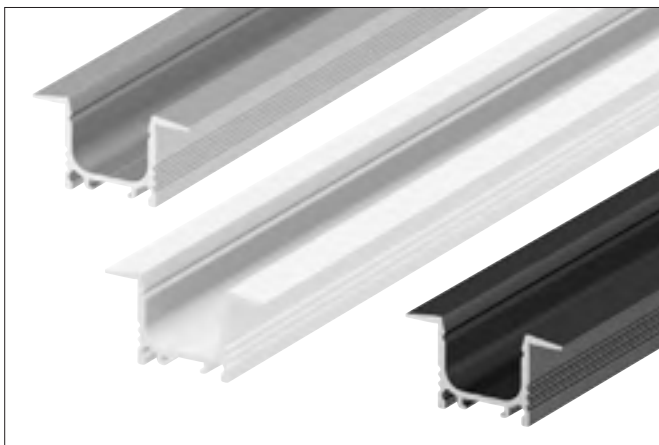

Einbauprofil, aluminium, weiß, schwarz

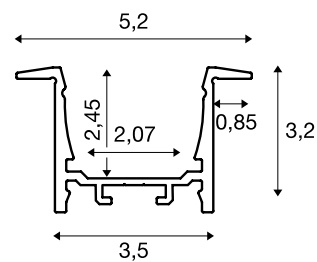

Länge	Farbe	Material	Art. Nr.
150 cm	<input type="checkbox"/> aluminium	Aluminium	1004924
	<input type="checkbox"/> weiß		1004925
	<input checked="" type="checkbox"/> schwarz		1004926
300 cm	<input type="checkbox"/> aluminium		1000496
	<input type="checkbox"/> weiß		1000497
	<input checked="" type="checkbox"/> schwarz		1000498

Breite/Höhe: 5,2/3,2 cm, max. Breite LED-Strip: 2,0 cm, Abdeckung exkl.

GRAZIA 20

ZUBEHÖR

ABDECKUNGEN



flach, transparent

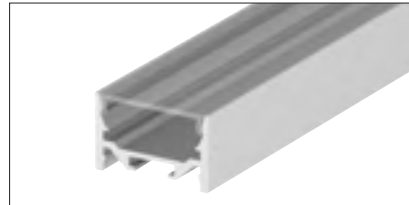

flach, transparent

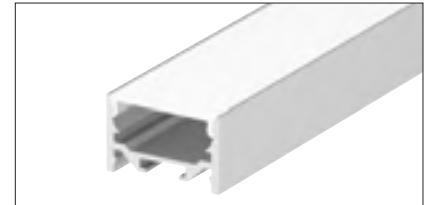

flach, milchig

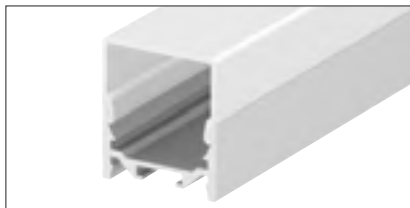

hoch, transparent

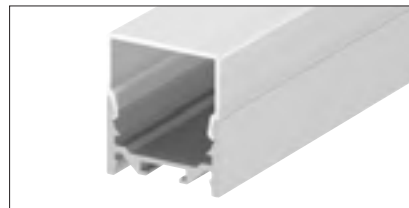

hoch, milchig

Länge	Farbe	Material	Art. Nr.
150 cm	<input type="checkbox"/> flach, gefrostet	Kunststoff PC	1004927
	<input type="checkbox"/> flach, gefrostet	Kunststoff PMMA	1004928
	<input type="checkbox"/> flach, milchig	Kunststoff PMMA	1004929
	<input type="checkbox"/> hoch, gefrostet*	Kunststoff PC	1004930
	<input type="checkbox"/> hoch, gefrostet*	Kunststoff PMMA	1004931
300 cm	<input type="checkbox"/> flach, gefrostet	Kunststoff PC	1000540
	<input type="checkbox"/> flach, gefrostet	Kunststoff PMMA	1000546
	<input type="checkbox"/> flach, milchig	Kunststoff PMMA	1000549
	<input type="checkbox"/> hoch, gefrostet*	Kunststoff PMMA	1000555
	<input type="checkbox"/> hoch, gefrostet*	Kunststoff PC	1000552

Kunststoff PMMA/PC:

Profil-Abdeckungen aus PMMA sind besonders homogen.

Profil-Abdeckungen aus PC sind bruchstabil und eignen sich sehr gut für Anwendungen mit hohem Anspruch an die Widerstandsfähigkeit.

* Die hohen Abdeckungen sind nur für GRAZIA 20 Aufbauprofile geeignet, nicht für die Einbauprofile.

LÄNGSVERBINDER



Beschreibung	Farbe	Maße	Art. Nr.
Längsverbinder	<input type="checkbox"/> aluminium	L/B/H: 3,8/1,4/0,4 cm	1000571

Material: Aluminium, Verpackungseinheit: 2 Stück

GRAZIA 20

ZUBEHÖR

ENDKAPPEN FÜR AUFBAUPROFIL

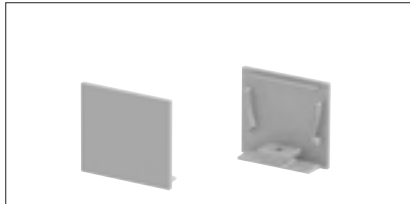

für Profil Standard, Abdeckung flach

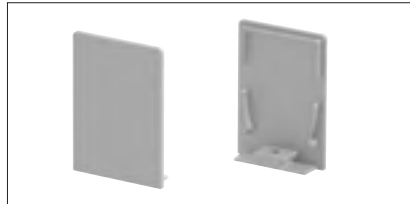

für Profil Standard, Abdeckung hoch

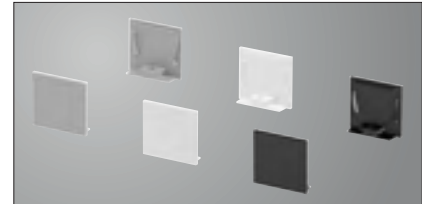

erhältliche Farbvarianten

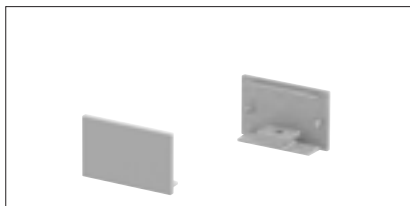

für Profil flach, Abdeckung flach

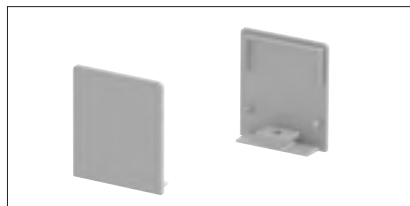

für Profil flach, Abdeckung hoch

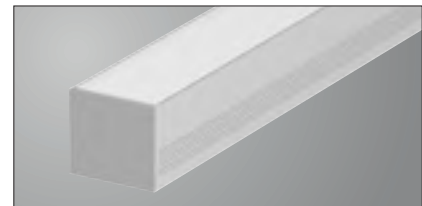

Profil mit montierter Endkappe

Beschreibung	Farbe	sichtbare Tiefe	Art. Nr.
Endkappe für Profil Standard, Abdeckung flach	<input type="checkbox"/> aluminium	0,25 cm	1000565
	<input type="checkbox"/> weiß		1000566
	<input type="checkbox"/> schwarz		1000567
Endkappe für Profil Standard, Abdeckung hoch	<input type="checkbox"/> aluminium	0,25 cm	1000568
	<input type="checkbox"/> weiß		1000569
	<input type="checkbox"/> schwarz		1000570
Endkappe für Profil flach, Abdeckung flach	<input type="checkbox"/> aluminium	0,25 cm	1000559
	<input type="checkbox"/> weiß		1000560
	<input type="checkbox"/> schwarz		1000561
Endkappe für Profil flach, Abdeckung hoch	<input type="checkbox"/> aluminium	0,25 cm	1000562
	<input type="checkbox"/> weiß		1000563
	<input type="checkbox"/> schwarz		1000564

Material: Aluminium, Verpackungseinheit: 2 Stück

i Bitte beachten Sie, dass bei der Verwendung von Endkappen die sichtbare Tiefe von der Profillänge abgezogen werden muss, um die gewünschte Gesamtlänge zu erhalten.

sichtbare Tiefe Endkappen + Profillänge = Gesamtlänge

ENDKAPPEN FÜR EINBAUPROFIL



für Einbauprofil



erhältliche Farbvarianten

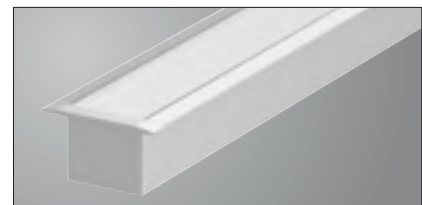

Profil mit montierter Endkappe

Beschreibung	Farbe	sichtbare Tiefe	Art. Nr.
Endkappe für Einbauprofil	<input type="checkbox"/> aluminium	0,085 cm	1000556
	<input type="checkbox"/> weiß	0,085 cm	1000557
	<input type="checkbox"/> schwarz	0,085 cm	1000558

Material: Aluminium, Verpackungseinheit: 2 Stück

i Bitte beachten Sie, dass bei der Verwendung von Endkappen die sichtbare Tiefe von der Profillänge abgezogen werden muss, um die gewünschte Gesamtlänge zu erhalten.

sichtbare Tiefe Endkappen + Profillänge = Gesamtlänge

PENDELABHÄNGUNG



Pendelabhängung (nur für Aufbauprofile)

Beschreibung	Maße	Art. Nr.
Pendelabhängung *	Pendel-L: 200 cm	1000535

Material: Edelstahl, Verpackungseinheit: 2 Stück

* Die Pendelabhängung ist nur für die Aufbauprofile geeignet.

MONTAGECLIPS

NEW VARIANT

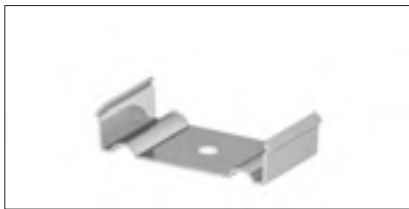

Montageclip, nicht sichtbar

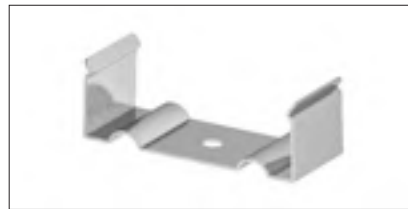

Montageclip, sichtbar (nur für gerillte Aufbau-profile)



Montageclip für Trockenbaudecken

Beschreibung	Maße	Art. Nr.
Montageclip, nicht sichtbar	L/B/H: 2,82/1,2/1,4 cm	1000536
Montageclip, sichtbar *	L/B/H: 3,65/6,2/1,5 cm	1000537
Montageclip	L/B/H: 5,5/1,1/2,3 cm	1004932

Material: Edelstahl, Verpackungseinheit: 2 Stück

* Der sichtbare Montageclip ist nur für die Profile **GRAZIA 20 Standard, gerillt** und **GRAZIA 20 Flach, gerillt** geeignet.



GRAZIA 60

AUF- UND EINBAUPROFIL

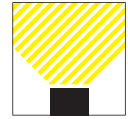

AUFBAUPROFIL

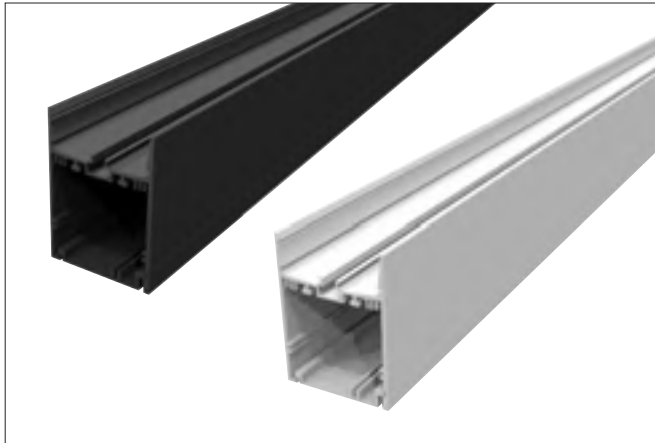

Aufbauprofil, schwarz, weiß

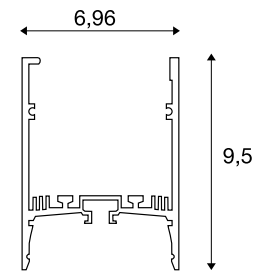

Länge	Farbe	Material	Art. Nr.
150 cm	<input checked="" type="checkbox"/> schwarz	Aluminium	1004896
	<input type="checkbox"/> weiß		1004897
300 cm	<input checked="" type="checkbox"/> schwarz		1004898
	<input type="checkbox"/> weiß		1004899

Breite/Höhe: 7/9,5 cm, max. Breite LED-Strip: 2,0 cm, Abdeckung exkl.

EINBAUPROFIL

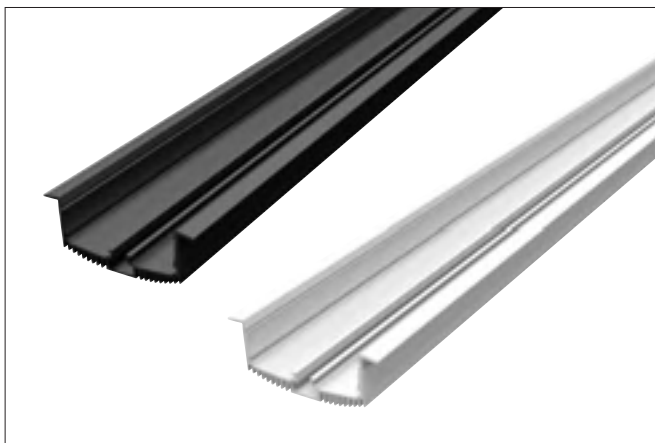

Einbauprofil, schwarz, weiß

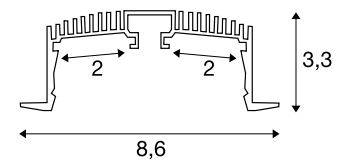

Länge	Farbe	Material	Art. Nr.
150 cm	<input checked="" type="checkbox"/> schwarz	Aluminium	1004905
	<input type="checkbox"/> weiß		1004906
300 cm	<input checked="" type="checkbox"/> schwarz		1004907
	<input type="checkbox"/> weiß		1004908

Breite/Höhe: 8,5/3,3 cm, max. Breite LED-Strip: 2,0 cm, Abdeckung exkl.

GRAZIA 60

ZUBEHÖR

ABDECKUNGEN



schwarz, Aluminium, 150 cm



weiß, Aluminium, 150 cm



gefrostet, Kunststoff PC, 150 cm



gefrostet, Kunststoff PMMA, 150 cm



gefrostet, Kunststoff PC, 300 cm



gefrostet, Kunststoff PC, 300 cm

Länge	Farbe	Material	Art. Nr.
150 cm	<input checked="" type="checkbox"/> schwarz	Aluminium	1004912
	<input type="checkbox"/> weiß	Aluminium	1004913
	<input type="checkbox"/> gefrostet	Kunststoff PC	1004914
	<input type="checkbox"/> gefrostet	Kunststoff PMMA	1004916
300 cm	<input type="checkbox"/> gefrostet	Kunststoff PC	1004915
	<input type="checkbox"/> gefrostet	Kunststoff PMMA	1004917

Kunststoff PMMA/PC:

Profil-Abdeckungen aus PMMA sind besonders homogen.

Profil-Abdeckungen aus PC sind bruchsicher und eignen sich sehr gut für Anwendungen mit hohem Anspruch an die Widerstandsfähigkeit.

ENDKAPPEN



für Aufbauprofil

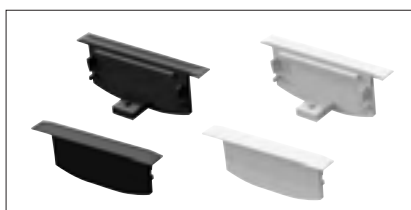

für Einbauprofil

Beschreibung	Farbe	sichtbare Tiefe	Art. Nr.
Endkappe für Aufbauprofil	<input checked="" type="checkbox"/> schwarz	0,085 cm	1004900
	<input type="checkbox"/> weiß	0,085 cm	1004901
Endkappe für Einbauprofil	<input checked="" type="checkbox"/> schwarz	0,085 cm	1004909
	<input type="checkbox"/> weiß	0,085 cm	1004910

Material: Aluminium, Verpackungseinheit: 2 Stück

i Bitte beachten Sie, dass bei der Verwendung von Endkappen die sichtbare Tiefe von der Profillänge abgezogen werden muss, um die gewünschte Gesamtlänge zu erhalten.

sichtbare Tiefe Endkappen + Profillänge = Gesamtlänge

GRAZIA 60

ZUBEHÖR

DECKENMONTAGEPROFIL FÜR AUFBAUPROFIL



Beschreibung	Farbe	Maße	Art. Nr.
Montagezubehör	■ schwarz	L/B/H: 150/7/9,5 cm	1004902

Material: Aluminium, Verpackungseinheit: 1 Stück

LÄNGSVERBINDER

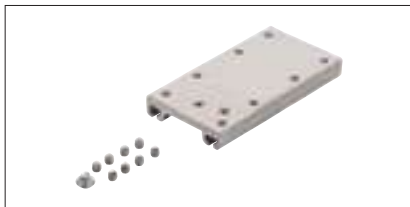

Beschreibung	Farbe	Maße	Art. Nr.
Längsverbinder	□ aluminium	L/B/H: 8/4,2/1 cm	1004903

Material: Aluminium, Verpackungseinheit: 2 Stück

EINSPEISER

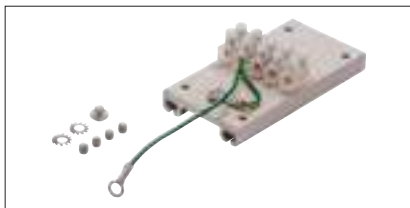

Beschreibung	Farbe	Maße	Art. Nr.
Einspeiser	□ aluminium	L/B/H: 8/4,2/2,4 cm	1004904

Material: Aluminium, Verpackungseinheit: 1 Stück

BEFESTIGUNGSCLIP FÜR EINBAUPROFIL

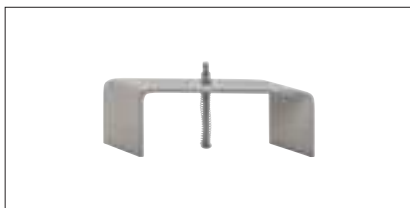

Beschreibung	Farbe	Maße	Art. Nr.
Befestigungsclip	■ chrom	L/B/H: 13/17/4 cm	1004911

Material: Stahl, Verpackungseinheit: 2 Stück

BEEINDRUCKEN AUF GANZER LINIE.

LED-STRIPS FÜR EINE
BESONDERE ATMOSPHERE.

Sie wollen Abwechslung ins Spiel bringen? LED-Strips sind moderne und außergewöhnliche Gestaltungselemente, die Räumen eine besondere Atmosphäre verleihen. Und auch als Wegweiser machen die länglichen Leuchten in vielen Farbvarianten eine gute Figur.





1004709 754

WELCHEN LED-STRIP BRAUCHE ICH?

LED-Strips und Profile für Ihr Projekt.
Alles auf einen Blick.

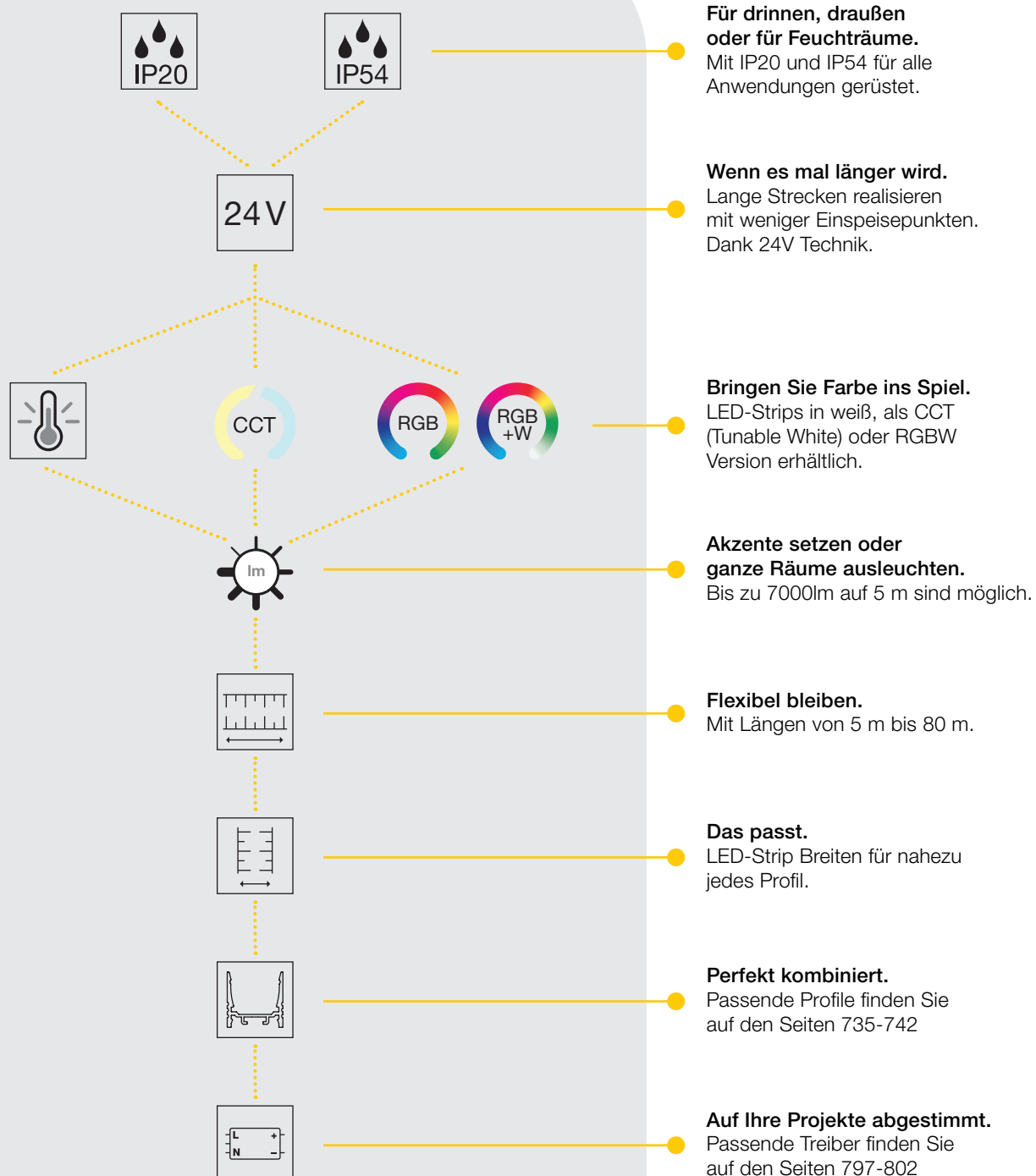

								LED-Strips	Profile
20	✓	2700-4000K	-	-	3500-3750lm	5 m	1 cm	GRAZIA FLEXSTRIP LED, 24V S. 754	GRAZIA 10 S. 735 GRAZIA 10 EDGE ab S. 738
20	✓	2700-4000K	-	-	6500-7000lm	5 m	1 cm	GRAZIA PRO FLEXSTRIP, 24V S. 755	GRAZIA 10 S. 735 GRAZIA 10 EDGE ab S. 738
20	✓	2700-6500K	-	-	8500-9100K	5 m	1 cm	GRAZIA PRO FLEXSTRIP, 24V S. 756	GRAZIA 10 S. 735 GRAZIA 10 EDGE ab S. 738
20	✓	3000-4000K	-	-	12500-13000lm	5 m	2 cm	GRAZIA PRO MAX FLEXSTRIP, 24V S. 757	GRAZIA 20 Aufbau S. 741 GRAZIA 20 Einbau S. 742
20	✓	3000-4000K	-	-	20000-21400lm	5 m	2 cm	GRAZIA PRO MAX FLEXSTRIP, 24V S. 758	GRAZIA 20 Aufbau S. 741 GRAZIA 20 Einbau S. 742
20	✓	2700-6500K	✓	-	3400-3700lm	5 m	1 cm	GRAZIA PRO FLEXSTRIP, Tunable white, 24V S. 759	GRAZIA 10 S. 735 GRAZIA 10 EDGE ab S. 738
20	✓	3000K	-	✓	2050-2500lm	5 m	2 cm	GRAZIA PRO FLEXSTRIP, RGBW, 24V S. 760	GRAZIA 20 Aufbau S. 741 GRAZIA 20 Einbau S. 742
54	✓	2700-4000K	-	-	3350-3600lm	5 m	2 cm	GRAZIA IP FLEXSTRIP, 24V S. 761	GRAZIA 20 Aufbau S. 741 GRAZIA 20 Einbau S. 742
54	✓	2700-6500K	-	-	3210-3500lm	5 m	2 cm	GRAZIA IP FLEXSTRIP, Tunable white, 24V S. 762	GRAZIA 20 Aufbau S. 741 GRAZIA 20 Einbau S. 742
54	✓	3000K	-	✓	1940-2350lm	5 m	2 cm	GRAZIA IP FLEXSTRIP, RGBW, 24V S. 763	GRAZIA 20 Aufbau S. 741 GRAZIA 20 Einbau S. 742

GRAZIA FLEXSTRIP LED

24V



GRAZIA FLEXSTRIP LED, 24V



LEDs pro Meter: 70
 Breite : 1 cm
 Höhe: 0.12 cm
 LED-Abstand: 1,4 cm
 Trennbar alle: 10 cm
 IP-Code: IP 20
 Beidseitig mit Einspeisekabel
 Vergoldete Kontakte

Farbtemperatur (K)	Lichtstrom (lm)	Leistung	Farbwiedergabeindex (CRI)	Farbkonsistenz (SDMC)	Länge (cm)	Art. Nr.
2700	3500	44W	90	3	500	1004708
3000	3500					1004709
4000	3750					1004710

Um eine gleichbleibende Lichtleistung ab einer Länge von 3 m zu erhalten, empfehlen wir die Strips beidseitig einzuspeisen.
 Ab einer Länge von 5 m muss neu eingespeist werden.



Variante	Strombelastung max.	Material	Länge (cm)	Breite (cm)	Höhe (cm)	Art. Nr.
<input type="checkbox"/> LED Netzteil	60W	Polycarbonat (PC)	18	4,5	2,7	1005383

 Um die Wärmeableitung zu gewährleisten, müssen die LED-Strips in ein Aluminiumprofil geklebt werden.
 Rückseite der LED-Strips mit Klebeband.

GRAZIA PRO FLEXSTRIP

24V



GRAZIA PRO FLEXSTRIP, 24V



LEDs pro Meter: 126
 Breite : 1 cm
 Höhe: 0,12 cm
 LED-Abstand: 0,8 cm
 Trennbar alle: 5,6 cm
 IP-Code: IP 20
 Beidseitig mit Einspeisekabel
 Vergoldete Kontakte

Farbtemperatur (K)	Lichtstrom (lm)	Leistung	Farbwiedergabeindex (CRI)	Farbkonsistenz (SDMC)	Länge (cm)	Art. Nr.
2700	6500					1004712
3000	6500	73W	90	3	500	1004713
4000	7000					1004714

Um eine gleichbleibende Lichtleistung ab einer Länge von 3 m zu erhalten, empfehlen wir die Strips beidseitig einzuspeisen.
 Ab einer Länge von 5 m muss neu eingespeist werden.



Variante	Strombelastung max.	Material	Länge (cm)	Breite (cm)	Höhe (cm)	Art. Nr.
■ LED Netzteil	100W	Polycarbonat (PC)	18,2	8,8	3,5	470500
■ LED Netzteil PHASE	100W	Polycarbonat (PC)	21	6,7	3,4	1003105
□ LED Netzteil DALI	100W	Polycarbonat (PC)	34,7	4	2,2	1004776



Um die Wärmeableitung zu gewährleisten, müssen die LED-Strips in ein Aluminiumprofil geklebt werden.
 Rückseite der LED-Strips mit Klebeband.

GRAZIA PRO FLEXSTRIP

24V



GRAZIA PRO FLEXSTRIP, 24V



LEDs pro Meter: 168
 Breite : 1 cm
 Höhe: 0.12 cm
 LED-Abstand: 0,6 cm
 Trennbar alle: 4,2 cm
 IP-Code: IP 20
 Beidseitig mit Einspeisekabel
 Vergoldete Kontakte

Farbtemperatur (K)	Lichtstrom (lm)	Leistung	Farbwiedergabeindex (CRI)	Farbkonsistenz (SDMC)	Länge (cm)	Art. Nr.
2700	8500					1004716
3000	8500					1004717
4000	9100	91W	90	3	500	1004718
6500	9100					1004719

Um eine gleichbleibende Lichtleistung ab einer Länge von 3 m zu erhalten, empfehlen wir die Strips beidseitig einzuspeisen. Ab einer Länge von 5 m muss neu eingespeist werden.



Variante	Strombelastung max.	Material	Länge (cm)	Breite (cm)	Höhe (cm)	Art. Nr.
■ LED Netzteil	100W	Polycarbonat (PC)	18,2	8,8	3,5	470500
■ LED Netzteil PHASE	100W	Polycarbonat (PC)	21	6,7	3,4	1003105
□ LED Netzteil DALI	100W	Polycarbonat (PC)	34,7	4	2,2	1004776



Um die Wärmeableitung zu gewährleisten, müssen die LED-Strips in ein Aluminiumprofil geklebt werden. Rückseite der LED-Strips mit Klebeband.

GRAZIA PRO MAX FLEXSTRIP

24V



GRAZIA PRO MAX FLEXSTRIP, 24V



LEDs pro Meter: 196
 Breite : 2 cm
 Höhe: 0.15 cm
 LED-Abstand: 0,5 cm
 Trennbar alle: 3,6 cm
 IP-Code: IP 20
 Beidseitig mit Einspeisekabel
 Vergoldete Kontakte

Farbtemperatur (K)	Lichtstrom (lm)	Leistung	Farbwiedergabeindex (CRI)	Farbkonsistenz (SDMC)	Länge (cm)	Art. Nr.
3000	12500	126W	90	3	500	1004720
4000	13000					1004721

Um eine gleichbleibende Lichtleistung ab einer Länge von 3 m zu erhalten, empfehlen wir die Strips beidseitig einzuspeisen.
 Ab einer Länge von 5 m muss neu eingespeist werden.



Variante	Strombelastung max.	Material	Länge (cm)	Breite (cm)	Höhe (cm)	Art. Nr.
■ LED Netzteil	150W	Polycarbonat (PC)	20,7	11	4,5	470549
□ DALI Controller	120W	Polycarbonat (PC)	11,6	4,2	1,8	1003106
□ LED Netzteil DALI	200W	Polycarbonat (PC)	42,5	4,8	2,5	1004777



Um die Wärmeableitung zu gewährleisten, müssen die LED-Strips in ein Aluminiumprofil geklebt werden.
 Rückseite der LED-Strips mit Klebeband.

GRAZIA PRO MAX FLEXSTRIP

24V



GRAZIA PRO MAX FLEXSTRIP, 24V



LEDs pro Meter: 196
 Breite : 2 cm
 Höhe: 0.15 cm
 LED-Abstand: 1 cm
 Trennbar alle: 7,1 cm
 IP-Code: IP 20
 Beidseitig mit Einspeisekabel
 Vergoldete Kontakte

Farbtemperatur (K)	Lichtstrom (lm)	Leistung	Farbwiedergabeindex (CRI)	Farbkonsistenz (SDMC)	Länge (cm)	Art. Nr.
3000	20000	193W	90	3	500	1004722
4000	21400					1004723

Um eine gleichbleibende Lichtleistung ab einer Länge von 3 m zu erhalten, empfehlen wir die Strips beidseitig einzuspeisen.
 Ab einer Länge von 5 m muss neu eingespeist werden.



Variante	Strombelastung max.	Material	Länge (cm)	Breite (cm)	Höhe (cm)	Art. Nr.
■ LED Netzteil	150W	Polycarbonat (PC)	20,7	11	4,5	470549
□ DALI Controller	120W	Polycarbonat (PC)	11,6	4,2	1,8	1003106
□ LED Netzteil DALI	200W	Polycarbonat (PC)	42,5	4,8	2,5	1004777



Um die Wärmeableitung zu gewährleisten, müssen die LED-Strips in ein Aluminiumprofil geklebt werden.
 Rückseite der LED-Strips mit Klebeband.

GRAZIA PRO FLEXSTRIP

TUNABLE WHITE, 24V



GRAZIA PRO FLEXSTRIP, TUNABLE WHITE, 24V



LEDs pro Meter: 224
 Breite : 1 cm
 Höhe: 0,12 cm
 LED-Abstand: 0,9 cm
 Trennbar alle: 6,3 cm
 IP-Code: IP 20
 Beidseitig mit Einspeisekabel
 Vergoldete Kontakte

Farbtemperatur (K)	Lichtstrom (lm)	Leistung	Farbwiedergabeindex (CRI)	Farbkonsistenz (SDMC)	Länge (cm)	Art. Nr.
2700-6500	3400-3700	80W	90	6	500	1004725

Um eine gleichbleibende Lichtleistung ab einer Länge von 3 m zu erhalten, empfehlen wir die Strips beidseitig einzuspeisen.
 Ab einer Länge von 5 m muss neu eingespeist werden.



Variante	Strombelastung max.	Material	Länge (cm)	Breite (cm)	Höhe (cm)	Art. Nr.
<input type="checkbox"/> LED Netzteil DALI, 24V, 2 Kanal	60W	Polycarbonat (PC)	20,2	5,8	3	1006133
<input type="checkbox"/> LED Netzteil DALI, 24V, 2 Kanal	100W	Polycarbonat (PC)	34,7	4	2,2	1006134



Um die Wärmeableitung zu gewährleisten, müssen die LED-Strips in ein Aluminiumprofil geklebt werden. Rückseite der LED-Strips mit Klebeband.

GRAZIA PRO FLEXSTRIP

RGBW, 24V



GRAZIA PRO FLEXSTRIP, RGBW, 24V



LEDs pro Meter: 70
 Breite : 1.2 cm
 Höhe: 0.22 cm
 LED-Abstand: 1,4 cm
 Trennbar alle: 10 cm
 IP-Code: IP 20
 Beidseitig mit Einspeisekabel
 Vergoldete Kontakte

Farbtemperatur (K)	Lichtstrom (lm)	Leistung	Farbwiedergabeindex (CRI)	Farbkonsistenz (SDMC)	Länge (cm)	Art. Nr.
RGB	2500	60				
W 3000	2050	27	>90	6SDCM	500	1004727

Um eine gleichbleibende Lichtleistung ab einer Länge von 3 m zu erhalten, empfehlen wir die Strips beidseitig einzuspeisen.
 Ab einer Länge von 5 m muss neu eingespeist werden.



Variante	Strombelastung max.	Material	Länge (cm)	Breite (cm)	Höhe (cm)	Art. Nr.
■ LED Netzteil	150W	Polycarbonat (PC)	20.7	11	4.5	470549

 Um die Wärmeableitung zu gewährleisten, müssen die LED-Strips in ein Aluminiumprofil geklebt werden.
 Rückseite der LED-Strips mit Klebeband.

GRAZIA IP FLEXSTRIP

24V



GRAZIA IP FLEXSTRIP, 24V



LEDs pro Meter: 70
 Breite : 1.2 cm
 Höhe: 0.4 cm
 LED-Abstand: 1,4 cm
 Trennbar alle: 10 cm
 IP-Code: IP 54
 Beidseitig mit Einspeisekabel
 Vergoldete Kontakte

Farbtemperatur (K)	Lichtstrom (lm)	Leistung	Farbwiedergabeindex (CRI)	Farbkonsistenz (SDMC)	Länge (cm)	Art. Nr.
2700	3350	44W	90	4	502	1004734
3000	3350					1004735
4000	3600					1004736

inkl. 2 Endkappen und Befestigungsmaterial

Um eine gleichbleibende Lichtleistung ab einer Länge von 3 m zu erhalten, empfehlen wir die Strips beidseitig einzuspeisen.
 Ab einer Länge von 5 m muss neu eingespeist werden.



Variante	Strombelastung max.	Material	Länge (cm)	Breite (cm)	Höhe (cm)	Art. Nr.
■ LED Netzteil	150W	Polycarbonat (PC)	23.4	11.4	4.9	470548
□ LED Netzteil	200W	Polycarbonat (PC)	34.7	4	2.2	1004776



Um die Wärmeableitung zu gewährleisten, müssen die LED-Strips in ein Aluminiumprofil geklebt werden.
 Rückseite der LED-Strips mit Klebeband.

GRAZIA IP FLEXSTRIP

TUNABLE WHITE, 24V



GRAZIA IP FLEXSTRIP, TUNABLE WHITE, 24V



LEDs pro Meter: 224
 Breite : 1.2 cm
 Höhe: 0.4 cm
 LED-Abstand: 0,9 cm
 Trennbar alle: 6,3 cm
 IP-Code: IP 54
 Beidseitig mit Einspeisekabel
 Vergoldete Kontakte

Farbtemperatur (K)	Lichtstrom (lm)	Leistung	Farbwiedergabeindex (CRI)	Farbkonsistenz (SDMC)	Länge (cm)	Art. Nr.
2700-6500	3210-3500	80W	90	4	502	1004726

inkl. 2 Endkappen und Befestigungsmaterial

Um eine gleichbleibende Lichtleistung ab einer Länge von 3 m zu erhalten, empfehlen wir die Strips beidseitig einzuspeisen. Ab einer Länge von 5 m muss neu eingespeist werden.



Variante	Strombelastung max.	Material	Länge (cm)	Breite (cm)	Höhe (cm)	Art. Nr.
■ LED Netzteil	150W	Polycarbonat (PC)	23,4	11,4	4,9	470548
□ LED Netzteil DALI, 24V, 2 Kanal	60W	Polycarbonat (PC)	20,2	5,8	3	1006133
□ LED Netzteil DALI, 24V, 2 Kanal	100W	Polycarbonat (PC)	34,7	4	2,2	1006134

 Um die Wärmeableitung zu gewährleisten, müssen die LED-Strips in ein Aluminiumprofil geklebt werden. Rückseite der LED-Strips mit Klebeband.

GRAZIA IP FLEXSTRIP

RGBW, 24V



GRAZIA IP FLEXSTRIP, RGBW, 24V



LEDs pro Meter: 70
 Breite : 1.4 cm
 Höhe: 0.46 cm
 LED-Abstand: 1,4 cm
 Trennbar alle: 10 cm
 IP-Code: IP 54
 Beidseitig mit Einspeisekabel
 Vergoldete Kontakte

Farbtemperatur (K)	Lichtstrom (lm)	Leistung	Farbwiedergabeindex (CRI)	Farbkonsistenz (SDMC)	Länge (cm)	Art. Nr.
RGB	2350	60				
W 3000K	1940	27	>90	6SDCM	500	1004737

inkl. 2 Endkappen und Befestigungsmaterial

Um eine gleichbleibende Lichtleistung ab einer Länge von 3 m zu erhalten, empfehlen wir die Strips beidseitig einzuspeisen. Ab einer Länge von 5 m muss neu eingespeist werden.



Variante	Strombelastung max.	Material	Länge (cm)	Breite (cm)	Höhe (cm)	Art. Nr.
■ LED Netzteil	150W	Polycarbonat (PC)	23.4	11.4	4.9	470548



Um die Wärmeableitung zu gewährleisten, müssen die LED-Strips in ein Aluminiumprofil geklebt werden. Rückseite der LED-Strips mit Klebeband.

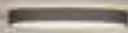



DALI ENTDECKEN. UND LICHT VERNETZEN.

Lernen Sie das Protokoll kennen, das die einfache Installation, Steuerung und Kommunikation einzelner Leuchten und Lichtinstallationen möglich macht.

Sie haben mit den Themen Smart Home oder Smart Building zu tun? Und möchten flexible Lichtszenarien und Inszenierungen frei gestalten? Vorhang auf für DALI und passende SLV Produkte: Das Digital Adressable Lighting Interface (DALI) macht die digitale Kommunikation zwischen elektronischen Vorschaltgeräten, Transformatoren und entsprechenden Stellgliedern einfach möglich: Flexibles Lichtmanagement für moderne Gebäude in Kombination mit der SLV-typischen Leuchtenvielfalt.

- Flexibles und intelligentes Lichtmanagement.
- Mit anderen Gebäudesystemen zentral steuerbar.
- Einfach zu installieren, universell einsetzbar.

Die Basis für intelligentes Licht.

DALI – eine exzellente Basis für das flexible und intelligente Lichtmanagement in modernen Gebäuden. Und mit DALI 2.0 ist es nun auch möglich, Sensoren in das Netzwerk zu integrieren. So können diese selbstständig auf den Bus zugreifen, mit einem Mastersteuergerät, Leuchtenbetriebsgeräten oder anderen Sensorsteuergeräten kommunizieren und Leuchten steuern.

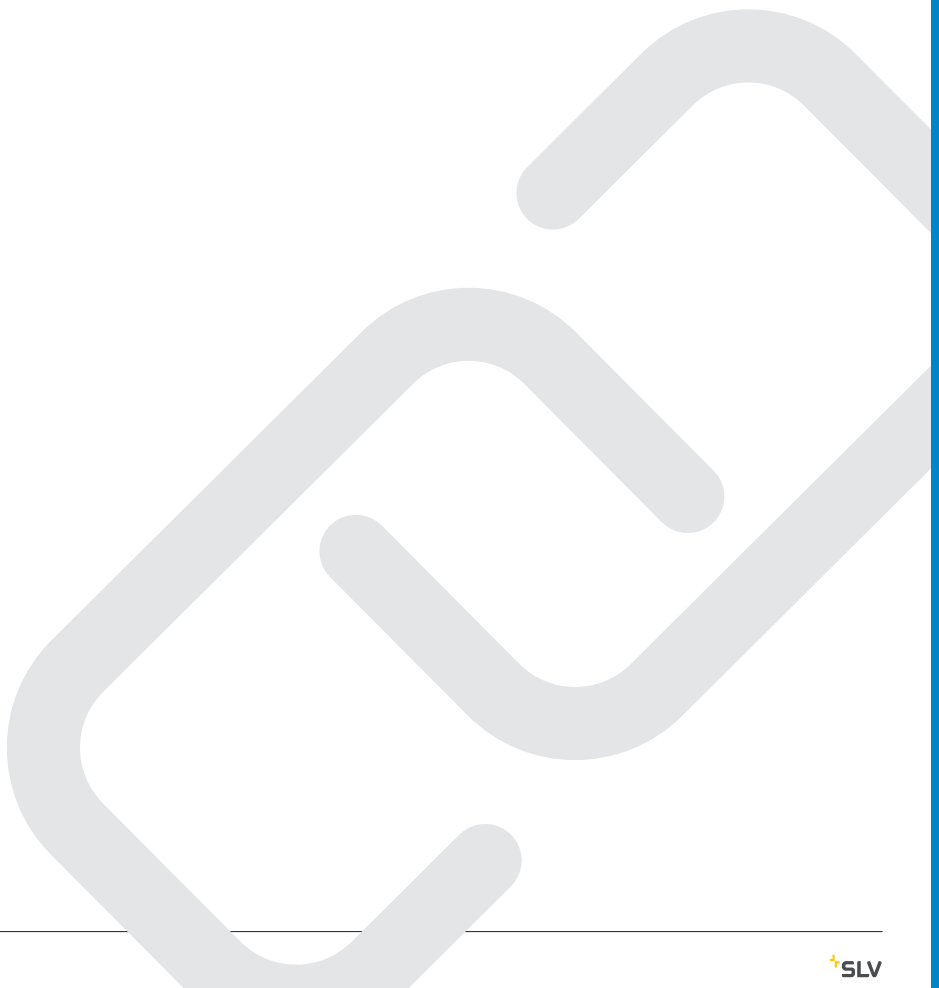

MIT SICHERHEIT KOMBINIERBAR: SLV, DALI UND SCHNEIDER ELECTRIC PRODUKTE.

In enger Zusammenarbeit mit Schneider Electric bieten wir eine maßgeschneiderte und einfach zu installierende Lösung an. Sie profitieren von SLV DALI Leuchten, die DALI 2.0 zum größten Teil schon unterstützen. Ausgiebige Tests garantieren dabei die Kompatibilität zwischen dem KNX DALI-Gateway von Schneider Electric und den SLV DALI Produkten.

So können Sie sämtliche SLV DALI Leuchten über die Schneider Electric Gateway einfach und nahtlos in ein übergeordnetes Gebäudemanagementsystem integrieren. Besonders das neu eingeführte NUMINOS® Leuchtensystem sowie unsere MEDO Familie bieten sich durch die überragende Kombinations- und Anwendungsvielfalt hierfür an. Entdecken Sie auf den nächsten Seiten weitere Leuchten von SLV, die sich mit DALI vernetzt steuern lassen.

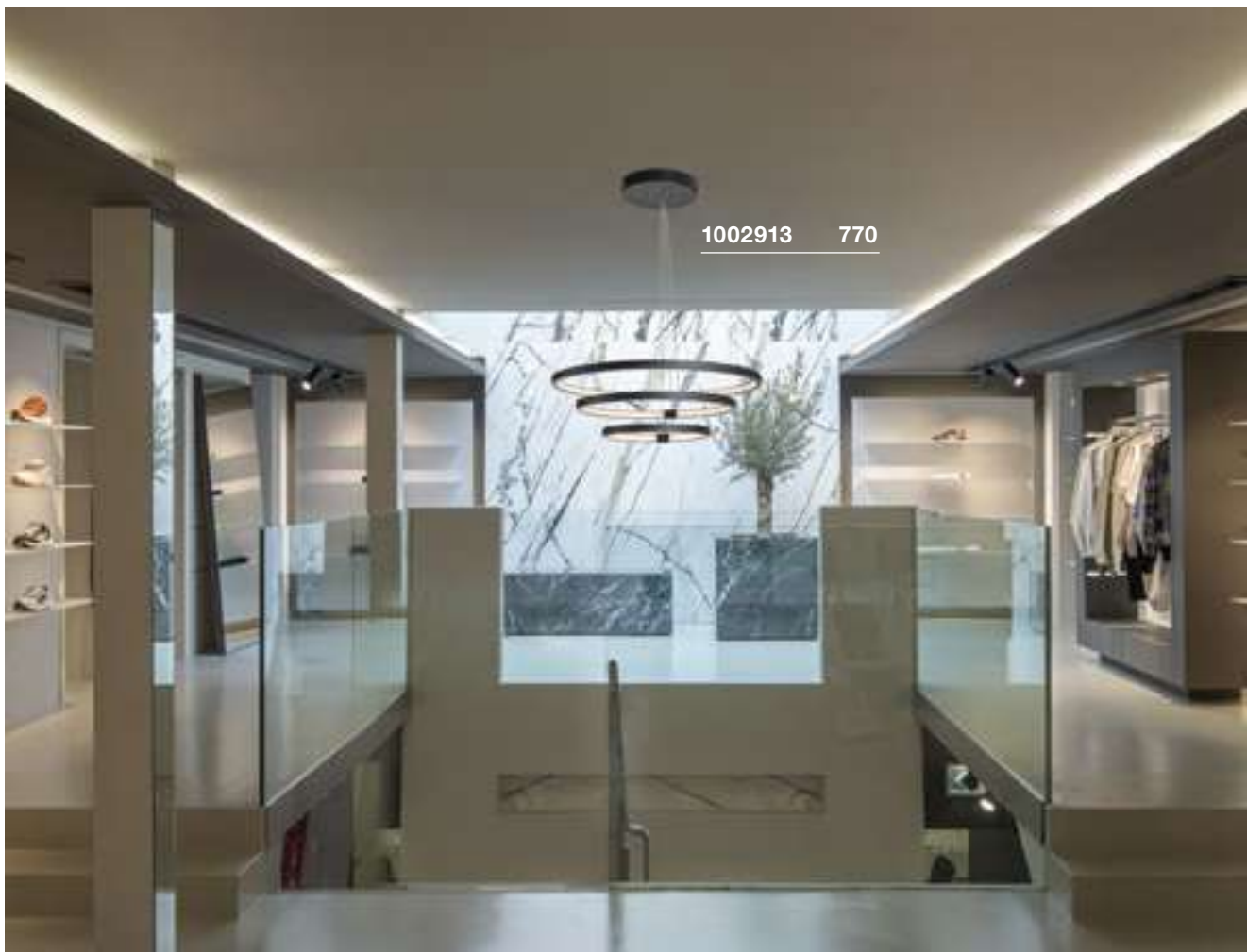

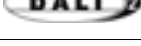

Leuchte	Seite	DALI Version	Kompatibilität mit Schneider Electric KNX/Dali Gateway
NUMINOS® 3Ph.	62-71		
NUMINOS® CW	72-79		
NUMINOS® CL	80-87		
NUMINOS® PD	88-95		
ONE 60/80/TRIPLE PD	119,120		
ONE 60/80/DOUBLE PD UP/DOWN	122,123		
ONE 40 WL	294		
ONE 40 TRACK 3Ph.	443		
WORKLIGHT PD DALI	146		
MEDO 30/40/60 AMBIENT CW	260-261		
MEDO 60 CL, quadratisch	261		
MEDO RING 60 PD	129		
MEDO 90 AMBIENT CL	261		
FERA 25 CL	284		
I-PENDANT PRO PD	140		
LIPSY® 40/50 CW Drum	330		
PANEL 60 CL rund	263		
PANEL CL 1200x300mm	263		
PANEL 60 PD rund	141		
PARA FLAC PD/CL	179		
Q-LINE® PD single	145		
SIGHT TRACK 3Ph.	440		
SIGHT MOVE 3Ph.	441		

DALI. TECHNISCH BELEUCHTET.

Alle Beleuchtungskomponenten müssen über eine DALI Schnittstelle verfügen. Dann lassen sich bis zu 64 Adressen, 16 Gruppen und 16 Szenen zentral verwalten. Der Status von Leuchtmitteln oder Betriebsgeräten einer Leuchte wird durch den bidirektionalen Datenaustausch über ein DALI-Steuergerät ausgelesen und gesetzt.

- Die Spannung liegt zwischen 9,5 und 22,5 V
- Der Systemstrom beträgt maximal 250 mA
- Die Datenübertragungsrate liegt bei 1.200 Baud
- DALI ist optional erweiterbar

Heizungsanlagen, Klimaanlage, Jalousiesysteme und noch vieles mehr – wenn 64 ansprechbare Adressen nicht genügen und neben der Lichtsteuerung noch weitere Systemkomponenten eines Gebäudes zentral gesteuert werden sollen, kein Problem: Räumlich aufgeteilt und via übergeordneter Steuerung lassen sich DALI-basierte Anwendungen über ein Gateway vernetzen. Üblicherweise kommt dabei ein KNX-System wie das neue Schneider Electric KNX/Dali Gateway zum Einsatz.



Alle DALI-fähigen Produkte sind im BIG WHITE® '22 mit Icon gekennzeichnet.





NUMINOS®
ZOOM M, 3Ph.
Art.-Nr.
1006117
Seite 71

Unser NUMINOS® Down- und Spotlightsystem finden Sie auf den Seiten 14 bis 95, passende DALI LED Treiber auf den Seiten 58 bis 60.

Oder ganz einfach online konfigurieren unter:

www.numinos.slv.com

EIN LEUCHTENSYSTEM. FÜR ALLE FÄLLE.

Und mit DALI 2.0 bestens verbunden. So lassen sich die Leuchten des SLV NUMINOS® Down- und Spotlightsystems überall dort perfekt einbinden, wo regelbare Beleuchtung gefragt ist. Ob als Akzentbeleuchtung oder zur Ausleuchtung von Verkaufsflächen, in der Gastronomie oder in Büros.



NUMINOS®
GIMBLE M, DL
Art.-Nr.
1005953
Seite 53



NUMINOS® XL
3Ph.
Art.-Nr.
1005796
Seite 69

ONE 60
PD, DALI

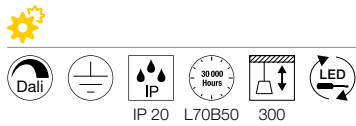
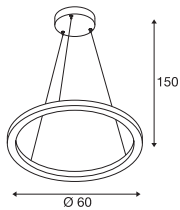
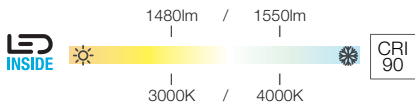
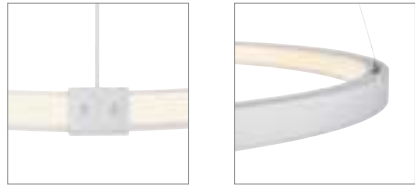

220-240V ~50/60Hz | 600mA
Systemleistung: 24W
Material: Aluminium / Stahl

ONE 80
PD, DALI

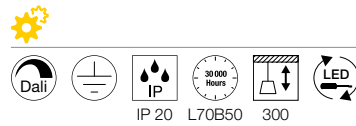
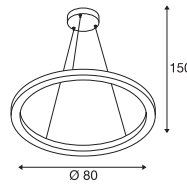
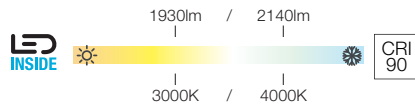

220-240V ~50/60Hz | 800mA
Systemleistung: 32W
Material: Aluminium / Stahl

ONE TRIPLE
PD, DALI

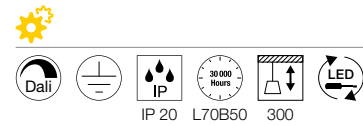
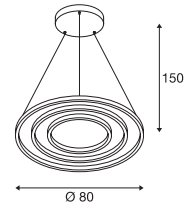
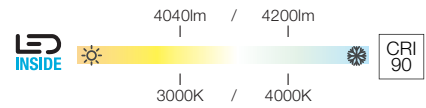

220-240V ~50/60Hz | 1700mA
Systemleistung: 64W
Material: Aluminium / Stahl

1002909, 1002910	1480/1550lm 3000/4000K	

Variante	Art. Nr.
1480/1550lm 3000/4000K CRI90	
■ schwarz	1002909
1480/1550lm 3000/4000K CRI90	
□ weiß	1002910

1002911, 1002912	1930/2140lm 3000/4000K	

Variante	Art. Nr.
1930/2140lm 3000/4000K CRI90	
■ schwarz	1002911
1930/2140lm 3000/4000K CRI90	
□ weiß	1002912

1002913, 1002914	4040/4200lm 3000/4000K	

Variante	Art. Nr.
4040/4200lm 3000/4000K CRI90	
■ schwarz	1002913
4040/4200lm 3000/4000K CRI90	
□ weiß	1002914



1002913 770



1002915 771

ONE 40
CW, DALI

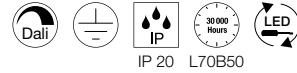
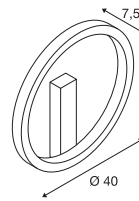
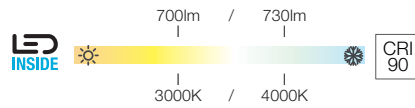

220-240V ~50/60Hz | 350mA
Systemleistung: 14W
Material: Aluminium / Stahl

ONE 60
WL, DALI

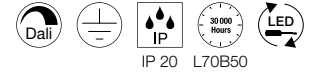
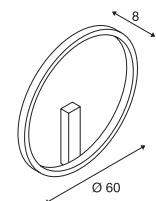
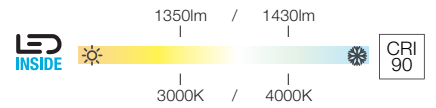
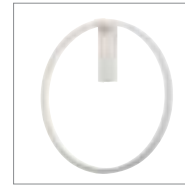

220-240V ~50/60Hz | 600mA
Systemleistung: 24W
Material: Aluminium / Stahl



1002915, 1002917	700/730lm 3000/4000K	

Variante	Art. Nr.
700/730lm 3000/4000K CRI90 Ø: 40 cm	
■ schwarz	1002915
700/730lm 3000/4000K CRI90 Ø: 40 cm	
□ weiß	1002917



1002918, 1002919	1350/1430lm 3000/4000K	

Variante	Art. Nr.
1350/1430lm 3000/4000K CRI90 Ø: 60 cm	
■ schwarz	1002918
1350/1430lm 3000/4000K CRI90 Ø: 60 cm	
□ weiß	1002919

ONE 40 TRACK
3Ph., DALI

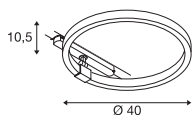
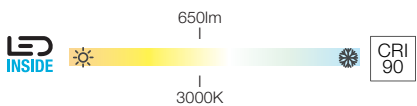

220-240V ~50/60Hz | 350mA
Systemleistung: 15,2W
Material: Aluminium

ONE 40 TRACK
3Ph., DALI

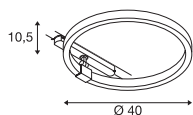
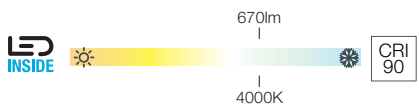

220-240V ~50/60Hz | 350mA
Systemleistung: 15,2W
Material: Aluminium



1004769, 1004770	650lm 3000K	



1004771, 1004772	670lm 4000K	

Variante	Art. Nr.
650lm 3000K CRI90	
■ schwarz	1004769
650lm 3000K CRI90	
□ weiß	1004770

Variante	Art. Nr.
670lm 4000K CRI90	
■ schwarz	1004771
670lm 4000K CRI90	
□ weiß	1004772



1004770 772



1004771 772



1004691 773



1004690 773

SIGHT MOVE
3Ph., DALI

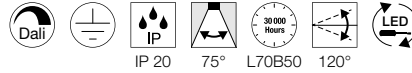
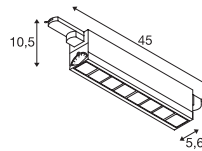
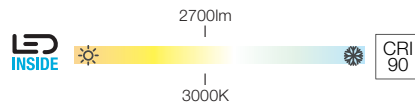

220-240V ~50/60Hz | 350mA
Systemleistung: 26W
Material: Aluminium / Polymethylacrylat (PMMA)

SIGHT MOVE
3Ph., DALI

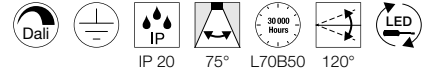
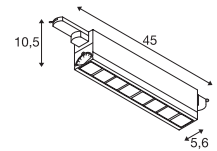
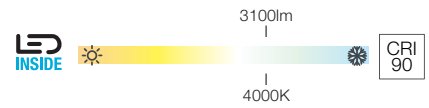

220-240V ~50/60Hz | 350mA
Systemleistung: 26W
Material: Aluminium / Polymethylacrylat (PMMA)



1004690, 1004691	2700lm 3000K	

Variante	Art. Nr.
2700lm 3000K CRI90	
■ schwarz	1004690
2700lm 3000K CRI90	
□ weiß	1004691



1004692, 1004693	3100lm 4000K	

Variante	Art. Nr.
3100lm 4000K CRI90	
■ schwarz	1004692
3100lm 4000K CRI90	
□ weiß	1004693

WORKLIGHT
PD, DALI

NEW

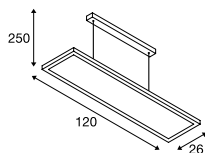
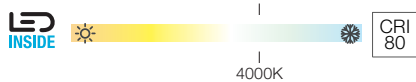

200-240V ~50/60Hz | 1500mA
Systemleistung: 57W
Material: Aluminium

1005395 774



Up	2000lm 4000K	
Down	3000lm 4000K	

Variante	Art. Nr.
Up: 2000lm 4000K CRI80 Down: 3000lm 4000K CRI80 ■ schwarz	1005395 ■
Up: 2000lm 4000K CRI80 Down: 3000lm 4000K CRI80 □ weiß	1005396 ■





1001309 775

Q-LINE®
PD, DALI, single

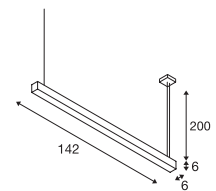
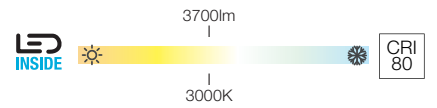

220-240V ~50/60Hz | 700mA
Systemleistung: 47W
Material: Aluminium / Acryl

















		A → G
1001309, 1001310	3700lm 3000K	A T G E

Variante	Art. Nr.
3700lm 3000K CRI80	
■ schwarz	1001309
3700lm 3000K CRI80	
□ weiß	1001310

MEDO LEUCHTENFAMILIE.

DECKEN- ODER PENDELLEUCHE.

	MEDO 30 AMBIENT CW, DALI	MEDO 40 AMBIENT CW, DALI	MEDO 60 AMBIENT CW, DALI	MEDO 90 AMBIENT CL, DALI	MEDO 60 CL, quadratisch, DALI
Beispiel					
Leuchtmittel					
Größe	Ø: 30 cm	Ø: 40 cm	Ø: 60 cm	Ø: 90 cm	B L: 60 cm
Lichtstärke	Down: 1230/1280lm Up: 20lm	Down: 2750/2900lm Up: 50lm	Down: 4350/4750lm Up: 120lm	Down: 9500/10100lm Up: 125lm	3300 lm
UGR	25	25	25	25	22
Dimmbar					
Abhängeset	1,5 m 5 m	1,5 m 5 m	1,5 m 5 m	1,5 m 5 m	1,5 m 5 m

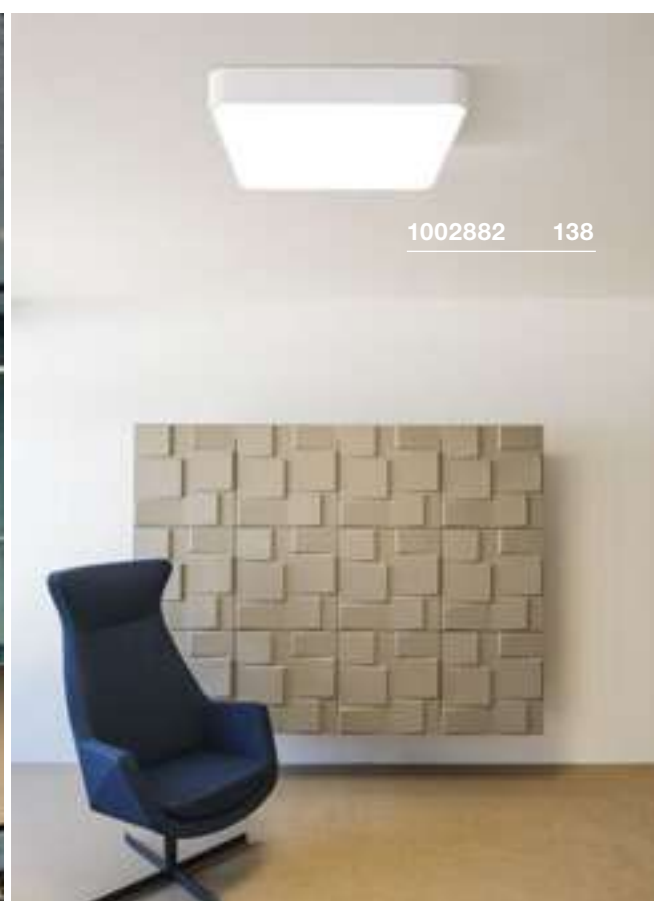



DALI INTERFACE
1-10V + on/off

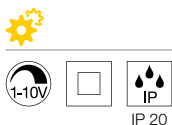

220-240V ~50/60Hz
L: 5,85 cm B: 3,25 cm H: 1,5 cm
Material: Kunststoff

- Zum Ansteuern von elektronischen Vorschaltgeräten mit 1-10V Steuereingang
- Galvanische Trennung von DALI-Eingang und 1-10V Ausgang

Leistung bis 1000W

Variante	Art. Nr.
■ grau	1002218

Hersteller: LUNATONE Industrielle Elektronik GmbH

DALI UNIVERSAL DIMMER
3-25W



220-240V ~50/60Hz
L: 5,85 cm B: 3,25 cm H: 1,5 cm
Material: Kunststoff

- Geeignet für R. L. C-Last dank automatischer Lasterkennung. DALI Stromaufnahme: 6mA

Leistung von 3W
Leistung bis 25W

Variante	Art. Nr.
■ grau	1002220

Hersteller: LUNATONE Industrielle Elektronik GmbH

DALI UNIVERSAL DIMMER
10-300W



220-240V ~50/60Hz
L: 12,02 cm B: 3,02 cm H: 2,16 cm
Material: Kunststoff

- Geeignet für R. L. C-Last dank automatischer Lasterkennung. DALI Stromaufnahme: 6mA

Leistung von 10W
Leistung bis 300W

Variante	Art. Nr.
■ grau	1002221

Hersteller: LUNATONE Industrielle Elektronik GmbH





EINFACH. KOMPATIBEL. SMART.

ZigBee® 3.0: das smarte Funkprotokoll.

Dimmen, Farben ändern, Lichtstimmungen auf Knopfdruck abrufen: Nicht nur Lichtsysteme basieren auf dem Standard ZigBee® 3.0. Vielseitig, mit minimalem Energieverbrauch und leichter Installation eignet sich der Funkstandard für alle, die Licht einfach vernetzen, sich aber nicht mit komplexer Technik beschäftigen möchten. Dabei ist für alle Arten von Wohnräumen, Häusern und Gewerberäumen eine theoretische Reichweite von bis zu 100 Metern möglich.

Das SLV VALETO® SMART LIGHT SYSTEM

Die intelligente Lichtlösung für das Zuhause, Hotels, Restaurants und Shops. Dank des ZigBee® 3.0 Standards genießen Sie die Kompatibilität mit vielen gängigen Smart Home Systemen:

Schneider Electric | Philips Hue | Amazon Alexa | uvm.

Die Steuerung funktioniert ganz einfach via Fernbedienung, App oder über Amazon Alexa. Natürlich lässt sich SLV VALETO® SMART LIGHT SYSTEM auch in bestehende Elektroinstallationen integrieren.

Hochkompatibel.

Mit Schneider Electric Produkten getestet.

Mit dem VALETO® SMART LIGHT SYSTEM bietet SLV eine zu einer Vielzahl von Systemen kompatible Lichtsteuerung auf Basis des ZigBee® 3.0 Standards an.

Schneider Electric PlusLink Produkte, die Schaltaktoren, Dimmer, Jalousien, Präsenzmelder sowie 1-10V- und DALI-Schnittstellen unterstützen, lassen sich einfach ins System integrieren.

So ist eine komplett nahtlose Schalterdesign-Integration mit diversen Schalterprogrammen möglich. Und im Rahmen der zukünftigen Zusammenarbeit mit Schneider Electric dürfen Sie sich auf weitere Anwendungslösungen freuen.



Skalierbar:

Mit dem SLV VALETO® Gateway lassen sich Installationen mit bis zu 200 Leuchten realisieren.



Integrierbar:

SLV VALETO® ist, dank des ZigBee® 3.0 Standards, kompatibel mit Produkten und Systemen anderer Hersteller.



Steuerbar:

Kann via App, Fernbedienung oder Sprachassistenzsysteme ganz einfach gesteuert werden.



Reichweitenstark:

Durch den Aufbau eines eigenen Mesh-Netzwerks lassen sich SLV VALETO® Produkte auch über große Distanzen steuern.*



Sicher:

Das Gateway speichert Ihre Daten nur lokal und speichert nichts in der Cloud.

*Ausgeschlossen sind die batteriebetriebenen Geräte.

SIMPLE.

Der ideale Einstieg in die smarte Lichtsteuerung: Koppeln Sie einfach unsere SLV VALETO® Fernbedienungen (bspw.: 1002994) mit den SLV VALETO® Leuchtmitteln (bspw.: 1001917) und sehen Sie wie einfach smart sein kann.



ADVANCE.

Darf es etwas mehr sein?

Mit unserem SLV VALETO® SMART LIGHT SYSTEM haben Sie die Wahl: Steuern Sie das Licht Zuhause mit unserer SLV VALETO® Fernbedienung (1002994), oder einer App auf Ihrem Smartphone über unser SLV VALETO® Gateway (1002411). Dank des neuesten ZigBee Standards (ZigBee® 3.0) sind Ihnen bei Ihrer smarten Lichtsteuerung keine Grenzen gesetzt.



PROFESSIONAL.

Große Pläne?

Mit unserem SLV VALETO® SMART LIGHT SYSTEM lassen sich problemlos über 150 smarte Produkte in einer smarten Lichtsteuerung integrieren. Steuern Sie ganz einfach zu jeder Zeit, von überall Ihre Geräte und setzen Sie Ihr Projekt perfekt in Szene.

MEHR KOMFORT UND SICHERHEIT

Die ideale Lösung zur kabellosen Bedienung und Überwachung von einzelnen Leuchten, über ganze Räume bis zur kompletten Wohnumgebung.

SLV VALETO® App

SLV VALETO® Gateway

Download on the App Store

GET IT ON Google Play



KOMMUNIKATION.

Das Herzstück des Smart Light Systems bildet das SLV VALETO® Gateway

SLV VALETO® Gateway



220-240V ~50/60Hz
Betriebsspannung: 5V DC
Leistung: <1W
L: 10,6 cm B: 10,6 cm H: 2,6 cm
Material: Aluminium/Kunststoff

ZigBee® 3.0 zertifiziertes Produkt.
Zur Steuerung des Gateway's wird eine Verbindung per LAN-Kabel zu einem Router vorausgesetzt.

Lieferumfang

SLV VALETO® Gateway
Steckernetzteil 5V, 1A
Netzwerkkabel, CAT6, 2m, schwarz



INTEGRIERBAR



GERMAN ENGINEERING



REICHWEITENSTARK



SICHER

Variante	Art. Nr.
aluminium/schwarz	1002411



Alle ZIGBEE-fähigen Produkte sind im BIG WHITE® '22 mit Icon gekennzeichnet.



**BEDIENELEMENT.****SLV VALETO®**
Fernbedienung, CCT/RGBW

IP 20

Spannung: 3V Batteriebetrieb
L: 6,5 cm B: 6,5 cm H: 1,95 cm
Material: Kunststoff PC

Die SLV VALETO® CCT/RGBW Fernbedienung kann bis zu 20 ZigBee® Geräte in drei Gruppen steuern. CCT und RGBW-Einstellungen möglich.

Variante	Art. Nr.
<input type="checkbox"/> weiß	1002994

**STEUERGERÄT.****SLV VALETO®**
Wandeinbau Dimmer

IP 20

220-240V ~50/60Hz
Leistung: max. 200W
L: 4,5 cm B: 4,5 cm H: 2,2 cm
Material: Kunststoff PC

Steuerbar mit SLV VALETO® CCT/RGBW Fernbedienung [1002994] oder Gateway [1002411].
Als unabhängiger Dimmer ohne ZigBee® nutzbar.
Dimmverfahren: Phasenabschnitt. Dimmer für ohmsche (Hochvolt Halogen Leuchtmittel) und kapazitive Lasten (LED Treiber). Passend für jede 60mm UP-Schaltdose mit einer Tiefe von 42mm. 200W LED Last.

Bemessungsspannung	220-240V ~50/60Hz
Ausgangsspannung	220-240V ~50/60Hz
Bemessungsleistung LED	200W
Umgebungstemp. max.	50°C

Variante	Art. Nr.
<input checked="" type="checkbox"/> schwarz	1002995

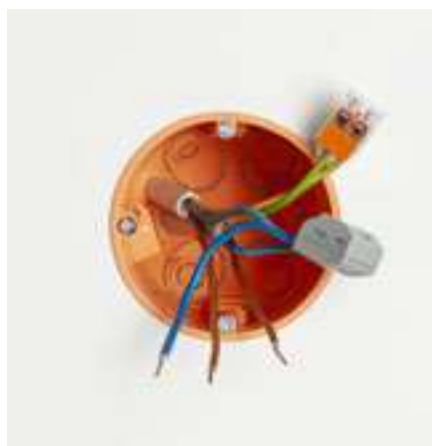

CONNECTED LED PANEL
595x595mm, UGR<19

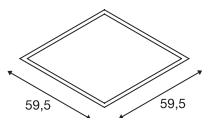
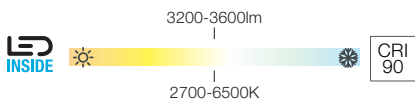

100-240V ~50/60Hz | 1050mA
Systemleistung: 43W
Material: Aluminium / Acryl

- Fernsteuerbar und dimmbar mit Remote Control CCT/DIM [1002994] oder Gateway [1002411]

CONNECTED LED PANEL
620x620mm, UGR<19

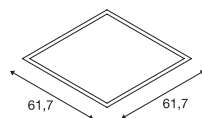
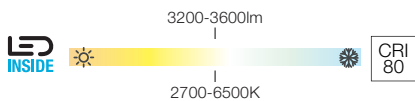

100-240V ~50/60Hz | 1050mA
Systemleistung: 43W
Material: Aluminium / Acryl

- Fernsteuerbar und dimmbar mit Remote Control CCT/DIM [1002994] oder Gateway [1002411]

1001250	3200-3600lm 2700-6500K		

Variante **Art. Nr.**
3200-3600lm | 2700-6500K | CRI90
 weiß **1001250**

1001251	3200-3600lm 2700-6500K		

Variante **Art. Nr.**
3200-3600lm | 2700-6500K | CRI80
 weiß **1001251**

1001250 784





1002858 785

MALANG CW

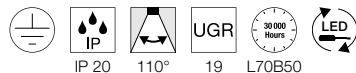
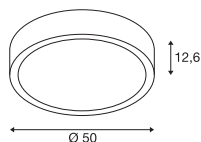
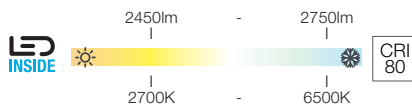

100-240V ~50/60Hz | 24V
Systemleistung: 39W
Material: Aluminium / Polyethylen (PE)

- Steuerbar und dimmbar mit SLV Valetto Fernbedienung 1002994 oder Gateway 1002411
- Ringlicht und Panel sind getrennt steuerbar (Zigbee 3.0)



Die Informationen zur Energieeffizienzklasse für dieses Produkt lagen bei Druck noch nicht vor. Die aktuellsten Produktdaten finden Sie jederzeit unter www.slv.com



- Abhängeset 1,5m Art. Nr.: 135250
- Abhängeset 1,5m Art. Nr.: 135251
- Abhängeset 1,5m Art. Nr.: 135254
- Abhängeset 5m Art. Nr.: 1001950
- Abhängeset 5m Art. Nr.: 1001951
- Abhängeset 5m Art. Nr.: 1001952
- SLV VALETO® | Fernbedienung, CCT/RGBW Art. Nr.: 1002994

Variante	Art. Nr.
Ring: 350lm RGB+W (3000K) CRI>80 Panel: 2100-2400lm 2700-6500K CRI>80 □ weiß	1002858

NEW FLAT WL, RGB-W

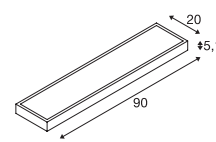
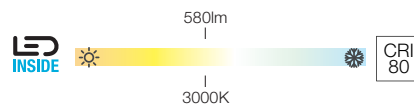
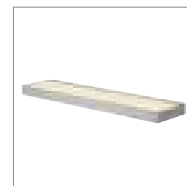
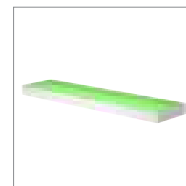

220-240V ~50/60Hz | 24V
Systemleistung: 11,3W
Material: Aluminium / Acryl

- Steuerbar mit Gateway Art-Nr. 1002411 oder Fernbedienung Art-Nr. 1002994



		A → G
Up	300lm 3000K	A T G
Down	280lm 3000K	A T G

Variante	Art. Nr.
Up: RGB-W (300lm 3000K CRI>80) Down: RGB-W (280lm 3000K CRI>80) □ weiß	1003022
Up: RGB-W (300lm 3000K CRI>80) Down: RGB-W (280lm 3000K CRI>80) ■ aluminium	1003023



LEUCHTMITTEL.

LED A60
 E27, tunable 2700-6500K, smart

NEW



220-240V ~50/60Hz
 Leistung: 9W
 Material: Polyamid 66 (PA 66)
 Ø: 6 cm H: 11 cm

Lichtstrom	800lm
Lampenstrom	0,067A
Farbwiedergabeindex	90
Leistung	9W
Energieverbrauch/1000h	9kWh



Variante	Art. Nr.
<input type="checkbox"/> weiß 2700-6500K	1005317

LED QPAR51
 GU10, tunable 2700-6500K, smart

NEW

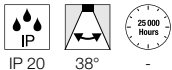

220-240V ~50/60Hz
 Leistung: 5W
 Material: Polyamid 66 (PA 66) / Polycarbonat (PC)
 Ø: 5 cm H: 5,4 cm

Lichtstrom	380lm
Lampenstrom	0,04A
max. Lichtstärke	530cd
Farbwiedergabeindex	90
Leistung	5W
Energieverbrauch/1000h	5kWh



Variante	Art. Nr.
<input type="checkbox"/> weiß 2700-6500K	1005311

LED A60
 E27, RGBW, smart

NEW



220-240V ~50/60Hz
 Leistung: 9W
 Material: Polyamid 66 (PA 66) / Polycarbonat (PC)
 Ø: 6 cm H: 11 cm

Lichtstrom	800lm
Lampenstrom	0,073A
Farbwiedergabeindex	90
Leistung	9W
Energieverbrauch/1000h	9kWh



Variante	Art. Nr.
<input type="checkbox"/> weiß / milchig	1005318

LED QPAR51
 GU10, RGBW, smart

NEW

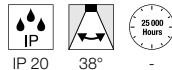

220-240V ~50/60Hz
 Leistung: 5,2W
 Material: Polyamid 66 (PA 66) / Polycarbonat (PC)
 Ø: 5 cm H: 6,1 cm

Lichtstrom	370lm
Lampenstrom	0,042A
max. Lichtstärke	680cd
Farbwiedergabeindex	90
Leistung	5,2W
Energieverbrauch/1000h	6kWh



Variante	Art. Nr.
<input type="checkbox"/> weiß	1005312

1002858 474





LEUCHTMITTEL.

QPAR111
GU10, tunable 2700-6500K, smart

NEW



220-240V ~50/60Hz
Leistung: 10W
Material: Aluminium / Polycarbonat (PC)
Ø: 11,1 cm H: 7 cm

LED QPAR111
GU10, RGBW, smart

NEW



220-240V ~50/60Hz
Leistung: 10W
Material: Aluminium
Ø: 11,1 cm H: 7 cm

LED QPAR111
GU10, RGBW, smart

NEW

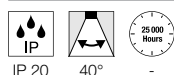

220-240V ~50/60Hz
Leistung: 10W
Material: Aluminium
Ø: 11,1 cm H: 7 cm

Lichtstrom	760lm
Lampenstrom	0,051A
max. Lichtstärke	4300cd
Farbwiedergabeindex	90
Leistung	10W
Energieverbrauch/1000h	10kWh

Lichtstrom	750lm
Lampenstrom	0,056A
max. Lichtstärke	3500cd
Farbwiedergabeindex	90
Leistung	10W
Energieverbrauch/1000h	10kWh

Lichtstrom	790lm
Lampenstrom	0,056A
max. Lichtstärke	3500cd
Farbwiedergabeindex	90
Leistung	10W
Energieverbrauch/1000h	10kWh



Variante	Art. Nr.
<input type="checkbox"/> weiß 2700-6500K	1005313
<input type="checkbox"/> weiß 2700-6500K	1005314



Variante	Art. Nr.
<input type="checkbox"/> weiß	1005315



Variante	Art. Nr.
<input type="checkbox"/> weiß	1005316



1003029 + 1000764 99 + 107

IN STRAHLENDER BEGLEITUNG.

ZUBEHÖR FÜR INDIVIDUELLE LICHTÄSTHETIK.

Licht hat viele Facetten. Und genauso vielfältig sind die Möglichkeiten, wenn es um die Beleuchtung von Räumen und Außenbereichen geht. Mit unserem Zubehör können diese Möglichkeiten noch erweitert und Umgebungen durch unterschiedliche Lichtinstallationen buchstäblich in ein neues Licht getaucht werden.



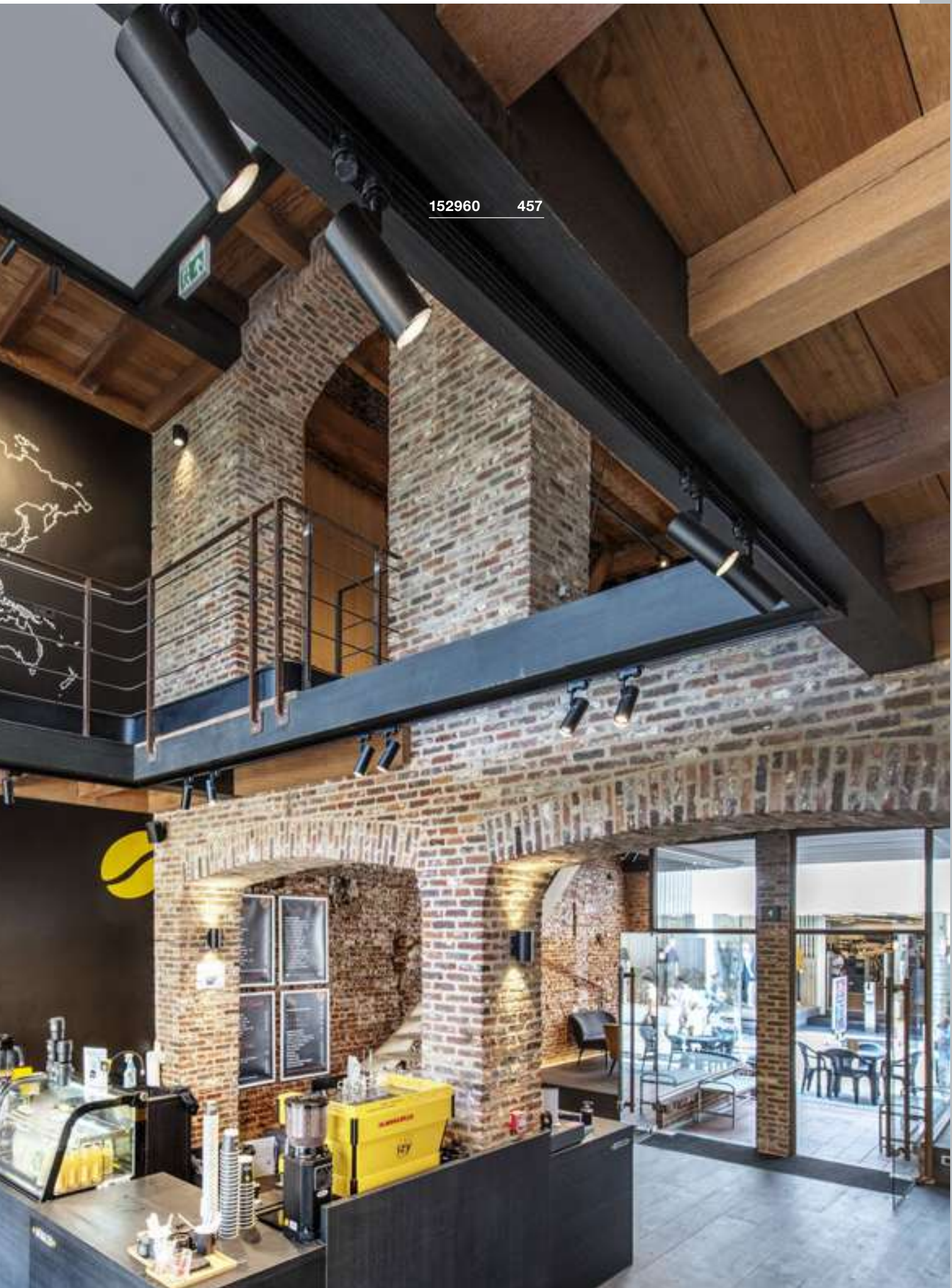

152960 457

FIND A DIMMER. GUT KOMBINIERT.

STIMMUNGSVOLLE RAUMBELEUCHTUNG DANK DER PERFEKTEN KOMBINATION AUS LEUCHTE UND DIMMER. **UNTER [FIND-A-DIMMER.SLV.COM](https://www.find-a-dimmer.slv.com)**

Beim Dimmen muss auf die Kompatibilität von Leuchten bzw. Leuchtmitteln und Dimmer geachtet werden. Und gerade bei LED Leuchtmitteln ist vorher zu prüfen, welcher Dimmer benötigt wird. Angesichts der vielen verschiedenen Produkte ist es nicht immer einfach, die optimale Kombination zu finden. Unsere „Find a Dimmer“ Übersicht soll Ihnen dabei helfen. Neben einer Vielzahl von Kombinationen aus dimmbaren Leuchten bzw. Leuchtmitteln und Dimmern, finden Sie unter

[find-a-dimmer.slv.com](https://www.find-a-dimmer.slv.com) auch weitere Informationen zur Mindestanzahl der für einen einwandfreien Betrieb benötigten Leuchten bzw. Leuchtmittel. **Die Übersicht wird regelmäßig aktualisiert und erweitert.**

Bei speziellen Anfragen kontaktieren Sie unseren techn. Support unter service@slv.de



1 Geeignet

- Ideales Dimmverhalten
- Die Mindestanzahl der für einen einwandfreien Betrieb benötigten Leuchten/ Leuchtmittel ist als Zahl angegeben.

1/ Nur bedingt geeignet

- kein optimales Dimmverhalten
- Flackern möglich

X Nicht kompatibel



[find-a-dimmer.slv.com](https://www.find-a-dimmer.slv.com)



ZUBEHÖR

Transformatoren IP44
12V AC



792

Transformatoren
12V AC



792

Transformatoren TENSEO
12V AC



793

1-10V Dimmer

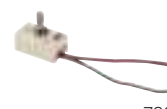

792

DALI Interface
1-10V



794

DALI Universal Dimmer



794

DALI Controller



794

Kompensationsmodul



794

LED Netzteile
12V/24V DC



795

LED Netzteile
24V DC



795

LED Netzteile
24V DC dimmbar



796

LED Treiber
DALI dimmbar



797, 800

LED Treiber
dimmbar



797-799

LED Treiber
nicht dimmbar



800-802

Deckenhaken



803

Kabelklemme



803

**GLENOS®
Deckenrosetten**

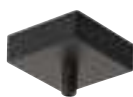

803

Textilkabel
10 m



803

Kabel
10 m klar



803

**Drahtseil-
abhängung**



803

**Stopper
für Drahtseil**



804

**Kabelver-
längerungen**
1 m
2 m



804

Steckerleiste
3 Ausgänge



804

**Doppelseitiges
Klebeband**



804

**Fassung
GU10**



804

**Fassung
GU10**



804

**Verbindungs-
boxen**



805

**T-Verbinder-
boxen**



805

Reduzierringe



806-807



Weiteres Zubehör finden Sie online unter www.slv.com

TRANSFORMATOR 12V AC | 10VA IP44

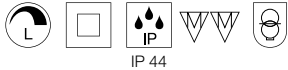

IP 44

220-240V 50/60Hz
L: 7,5 cm B: 5 cm H: 4,5 cm
Material: Kunststoff

Ausgangsspannung	12V AC
Leistung bis	10W
Leistungsfaktor Betriebsgerät	0,98
Temperaturschutz	133°C
Anzahl Sekundärausgänge	1

Variante	Art. Nr.
■ schwarz	227140 ▼

Hersteller: Elektromaschinenbau Wittlich GmbH

TRANSFORMATOR 12V AC | 60VA IP44



IP 44

220-240V 50/60Hz
L: 7,5 cm B: 5 cm H: 4,5 cm
Material: Kunststoff

Ausgangsspannung	12V AC
Leistung bis	60W
Leistungsfaktor Betriebsgerät	0,98
Temperaturschutz	133°C
Anzahl Sekundärausgänge	1

Variante	Art. Nr.
■ schwarz	227160 ▼

Hersteller: Elektromaschinenbau Wittlich GmbH

TRANSFORMATOR 12V AC | 150VA



IP 20

220-240V 50/60Hz
L: 16,6 cm B: 3,9 cm H: 3,3 cm
Material: Kunststoff

Ausgangsspannung	12V AC
Leistung von	50W
Leistung bis	150W
Leistungsfaktor Betriebsgerät	0,98
Temperaturschutz	110°C
Anzahl Sekundärausgänge	3

Variante	Art. Nr.
■ schwarz	461157

Hersteller: WeiSen Electronic Co., Ltd

TRANSFORMATOR 12V AC | 60VA



IP 20

220-240V 50/60Hz
L: 10,5 cm B: 3,3 cm H: 2,2 cm
Material: Polycarbonat (PC)

Ausgangsspannung	12V AC
Leistung von	10W
Leistung bis	60W
Leistungsfaktor Betriebsgerät	0,98
Temperaturschutz	110°C
Anzahl Sekundärausgänge	1

Variante	Art. Nr.
□ weiß	461060

Hersteller: HEP GmbH

1-10V DIMMER 10W

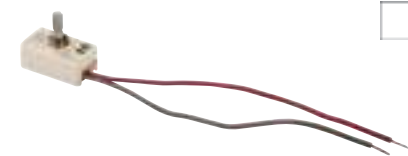

IP 20

L: 2,3 cm B: 3,9 cm H: 2 cm
Material: Polycarbonat (PC)

Variante	Art. Nr.
□ weiß	470505

Hersteller: HEP GmbH

TRANSFORMATOR TENSEO

12V AC | 50VA

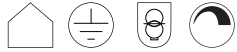

220-240V 50/60Hz
Stahl / Messing
H: 11 cm
Ø: 11,1 cm

Ausgangsspannung	12V AC
Anzahl Ausgänge sek.	1
Nennleistung VA	50
Leistung bis	50W
Temperaturschutz	130°C
Absicherung prim.	1,6A

Variante	Art. Nr.
<input checked="" type="checkbox"/> schwarz	1002691
<input type="checkbox"/> weiß	1002692
<input type="checkbox"/> chrom	1002693

TRANSFORMATOR TENSEO

12V AC | 105VA



220-240V 50/60Hz
Stahl / Messing
H: 11 cm
Ø: 11,1 cm

Ausgangsspannung	12V AC
Anzahl Ausgänge sek.	1
Nennleistung VA	105
Leistung bis	105W
Temperaturschutz	130°C
Absicherung prim.	1,6A

Variante	Art. Nr.
<input type="checkbox"/> weiß	138981
<input checked="" type="checkbox"/> chrom	138982

TRANSFORMATOR TENSEO

12V AC | 210VA

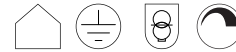

220-240V 50/60Hz
Stahl / Messing
H: 11 cm
Ø: 13,5 cm

Ausgangsspannung	12V AC
Anzahl Ausgänge sek.	1
Nennleistung VA	210
Leistung bis	210W
Temperaturschutz	130°C
Absicherung prim.	3,15A

Variante	Art. Nr.
<input type="checkbox"/> weiß	138991
<input checked="" type="checkbox"/> chrom	138992



DALI INTERFACE 1-10V + on/off

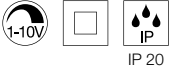

220-240V ~50/60Hz
L: 5,85 cm B: 3,25 cm H: 1,5 cm
Material: Kunststoff

- Zum Ansteuern von elektronischen Vorschaltgeräten mit 1-10V Steuereingang
- Galvanische Trennung von DALI-Eingang und 1-10V Ausgang

Leistung bis 1000W

Variante	Art. Nr.
■ grau	1002218

Hersteller: LUNATONE Industrielle Elektronik GmbH

DALI UNIVERSAL DIMMER 3-25W



220-240V ~50/60Hz
L: 5,85 cm B: 3,25 cm H: 1,5 cm
Material: Kunststoff

- Geeignet für R. L. C-Last dank automatischer Lasterkennung. DALI Stromaufnahme: 6mA

Leistung von 3W
Leistung bis 25W

Variante	Art. Nr.
■ grau	1002220

Hersteller: LUNATONE Industrielle Elektronik GmbH

DALI UNIVERSAL DIMMER 10-300W



220-240V ~50/60Hz
L: 12,02 cm B: 3,02 cm H: 2,16 cm
Material: Kunststoff

- Geeignet für R. L. C-Last dank automatischer Lasterkennung. DALI Stromaufnahme: 6mA

Leistung von 10W
Leistung bis 300W

Variante	Art. Nr.
■ grau	1002221

Hersteller: LUNATONE Industrielle Elektronik GmbH

DALI CONTROLLER 24V DC

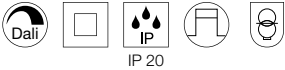

10-24V DC
L: 11,6 cm B: 4,2 cm H: 1,8 cm
Material: Polycarbonat (PC)

Ausgangsspannung 10-24V DC
Anzahl Sekundärausgänge 1

Variante	Art. Nr.
□ weiß / grau	1003106

KOMPENSATIONSMODUL



220-240V ~50/60Hz
L: 9,5 cm
Ø: 1,5 cm
Material: Polycarbonat (PC)

- Verringert oder beseitigt Probleme beim Dimmen, wie Flimmern, Blinken oder wenn die LED-Beleuchtung nach dem Ausschalten nicht zu 100% erlischt. Der Kompensator wird immer nach dem Dimmer oder Schalter und parallel zum Downlight-Spot oder LED-Treiber an

Variante	Art. Nr.
■ glänzend schwarz	1002785 ▼



LED NETZTEIL
12V | 15W

NEW

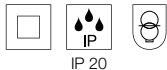

200-240V ~50/60Hz
H: 22 cm Ø: 55 cm
Material: Polycarbonat (PC)

Ausgangsspannung	12V DC
Leistung von	0W
Leistung bis	15W
Leistungsfaktor Betriebsgerät	0,9
Temperaturschutz	110°C
Anzahl Sekundärausgänge	1

Variante	Art. Nr.
<input type="checkbox"/> weiß	1005444 ■

Hersteller: HEP GmbH

LED NETZTEIL
24V | 15W

NEW

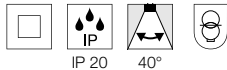
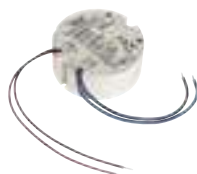

200-240V ~50/60Hz
H: 22 cm Ø: 55 cm
Material: Polycarbonat (PC)

Ausgangsspannung	24V DC
Leistung von	0W
Leistung bis	15W
Leistungsfaktor Betriebsgerät	0,9
Temperaturschutz	110°C
Anzahl Sekundärausgänge	1

Variante	Art. Nr.
<input type="checkbox"/> weiß	1005445 ■

Hersteller: HEP GmbH

LED NETZTEIL
12V | 12W mit Zugentlastung

NEW

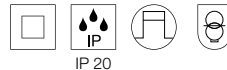

100-240V ~50/60Hz
L: 10,6 cm B: 3,3 cm H: 2,2 cm
Material: Polycarbonat (PC)

Ausgangsspannung	12
Leistung von	0W
Leistung bis	12W
Leistungsfaktor Betriebsgerät	0,9
Temperaturschutz	110°C
Anzahl Sekundärausgänge	1

Variante	Art. Nr.
<input type="checkbox"/> weiß	1005241 ■

Hersteller: HEP GmbH

LED NETZTEIL
24V | 12W mit Zugentlastung

NEW

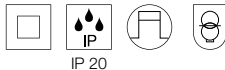

100-240V ~50/60Hz
L: 10,6 cm B: 3,3 cm H: 2,2 cm
Material: Polycarbonat (PC)

Ausgangsspannung	24
Leistung von	0W
Leistung bis	12W
Leistungsfaktor Betriebsgerät	0,9
Temperaturschutz	110°C
Anzahl Sekundärausgänge	1

Variante	Art. Nr.
<input type="checkbox"/> weiß	1005380 ■

Hersteller: HEP GmbH

LED NETZTEIL
24V | 20W

NEW



220-240V ~50/60Hz
L: 11,5 cm B: 4,1 cm H: 2,5 cm
Material: Polycarbonat (PC)

Ausgangsspannung	24V DC
Leistung von	0W
Leistung bis	20W
Leistungsfaktor Betriebsgerät	0,95
Temperaturschutz	110°C
Anzahl Sekundärausgänge	1

Variante	Art. Nr.
<input type="checkbox"/> weiß	1005381 ■

Hersteller: HEP GmbH

LED NETZTEIL
24V | 40W

NEW



220-240V ~50/60Hz
L: 18 cm B: 4,5 cm H: 2,7 cm
Material: Polycarbonat (PC)

Ausgangsspannung	24V DC
Leistung von	0W
Leistung bis	40W
Leistungsfaktor Betriebsgerät	0,9
Temperaturschutz	110°C
Anzahl Sekundärausgänge	1

Variante	Art. Nr.
<input type="checkbox"/> weiß	1005382 ■

Hersteller: HEP GmbH

LED NETZTEIL

24V DC | 150W inkl. Zulentlastung



IP 20

220-240V ~50/60Hz
L: 20,7 cm B: 11 cm H: 4,5 cm
Material: Polycarbonat (PC)

Ausgangsspannung	24V DC
Leistung von	0W
Leistung bis	150W
Leistungsfaktor Betriebsgerät	0,98
Temperaturschutz	110°C
Anzahl Sekundärausgänge	1

Variante	Art. Nr.
■ schwarz	470549 ▼

Hersteller: HEP GmbH

LED NETZTEIL

24V | 60W



220-240V ~50/60Hz
L: 18 cm B: 4,5 cm H: 2,7 cm
Material: Polycarbonat (PC)

Ausgangsspannung	24V DC
Leistung von	0W
Leistung bis	60W
Leistungsfaktor Betriebsgerät	0,95
Temperaturschutz	110°C
Anzahl Sekundärausgänge	1

Variante	Art. Nr.
□ weiß	1005383 ■

Hersteller: HEP GmbH

LED NETZTEIL

24V DC | 100W inkl. Zulentlastung



IP 20

220-240V ~50/60Hz
L: 18,2 cm B: 8,8 cm H: 3,5 cm
Material: Polycarbonat (PC)

Ausgangsspannung	24V DC
Leistung von	0W
Leistung bis	100W
Leistungsfaktor Betriebsgerät	0,95
Temperaturschutz	110°C
Anzahl Sekundärausgänge	2

Variante	Art. Nr.
■ schwarz	470500

Hersteller: HEP GmbH

LED NETZTEIL

24V DC | 150W



IP 44

220-240V ~50/60Hz
L: 23,4 cm B: 11,4 cm H: 4,9 cm
Material: Polycarbonat (PC)

Ausgangsspannung	24V DC
Leistung von	0W
Leistung bis	150W
Temperaturschutz	110°C
Anzahl Sekundärausgänge	1

Variante	Art. Nr.
■ schwarz	470548

Hersteller: HEP GmbH

LED NETZTEIL

24V | 50W inkl. Zulentlastung



IP 20

220-240V ~50/60Hz
L: 18,4 cm B: 6,1 cm H: 3,2 cm
Material: Polycarbonat (PC)

Ausgangsspannung	24V DC
Leistung von	12W
Leistung bis	50W
Leistungsfaktor Betriebsgerät	0,95
Temperaturschutz	110°C
Anzahl Sekundärausgänge	1

Variante	Art. Nr.
■ weiß / blau	1003104

LED NETZTEIL

24V DC | 100W inkl. Zulentlastung



IP 20

220-240V ~50/60Hz
L: 21 cm B: 6,7 cm H: 3,4 cm
Material: Polycarbonat (PC)

Ausgangsspannung	24V DC
Leistung von	34W
Leistung bis	100W
Leistungsfaktor Betriebsgerät	0,95
Temperaturschutz	110°C
Anzahl Sekundärausgänge	1

Variante	Art. Nr.
■ weiß / blau	1003105

LED NETZTEIL
12V | 100W inkl. Zugentlastung

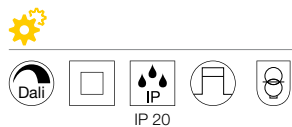

220-240V ~50/60Hz
L: 34,7 cm B: 4 cm H: 2,2 cm
Material: Polycarbonat (PC)

Ausgangsspannung	24V DC
Leistung von	5W
Leistung bis	100W
Leistungsfaktor Betriebsgerät	0,95
Temperaturschutz	110°C
Anzahl Sekundärausgänge	1

Variante	Art. Nr.
<input type="checkbox"/> weiß	1004776

Hersteller: HEP GmbH

LED NETZTEIL
60W | DALI, 24V, 2 Kanal

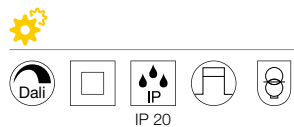

220-240V ~50/60Hz
L: 20,2 cm B: 5,8 cm H: 3 cm
Material: Polycarbonat (PC)

Ausgangsspannung	24V DC
Leistung von	5W
Leistung bis	60W
Leistungsfaktor Betriebsgerät	0,95
Temperaturschutz	110°C
Anzahl Sekundärausgänge	2

Variante	Art. Nr.
<input type="checkbox"/> weiß	1006133 ■

Hersteller: HEP GmbH

LED NETZTEIL
100W | DALI, 24V, 2 Kanal

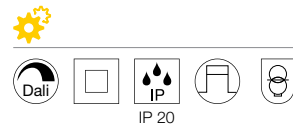

220-240V ~50/60Hz
L: 34,7 cm B: 4 cm H: 2,2 cm
Material: Polycarbonat (PC)

Leistung von	5W
Leistung bis	100W
Leistungsfaktor Betriebsgerät	0,95
Temperaturschutz	110°C
Anzahl Sekundärausgänge	2

Variante	Art. Nr.
<input type="checkbox"/> weiß	1006134 ■

Hersteller: HEP GmbH

LED TREIBER
DALI

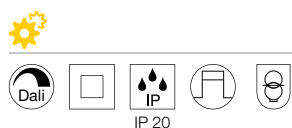

220-240V ~50/60Hz
L: 42,5 cm B: 4,8 cm H: 2,5 cm
Material: Polycarbonat (PC)

Ausgangsspannung	24V DC
Leistung von	5W
Leistung bis	200W
Leistungsfaktor Betriebsgerät	0,95
Temperaturschutz	90°C
Anzahl Sekundärausgänge	1

Variante	Art. Nr.
<input type="checkbox"/> weiß	1004777 ■

Hersteller: HEP GmbH

LED TREIBER
200mA | 6-8,4W inkl. Zugentlastung

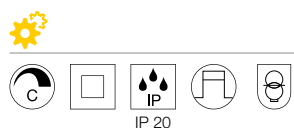

220-240V ~50/60Hz
L: 8,5 cm B: 4,1 cm H: 2,2 cm
Material: Polycarbonat (PC)

Ausgangsspannung	30-42V DC
Leistung von	6W
Leistung bis	8,4W
Leistungsfaktor Betriebsgerät	0,9
Temperaturschutz	110°C
Anzahl Sekundärausgänge	1

Variante	Art. Nr.
<input type="checkbox"/> weiß	1003254

Hersteller: HEP GmbH

LED TREIBER
350mA | 3W

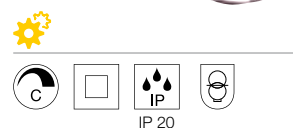

220-240V ~50/60Hz
L: 6,3 cm B: 4 cm H: 2,3 cm
Material: Polycarbonat (PC)

Ausgangsspannung	10-17V DC
Leistung von	3,5W
Leistung bis	5,9W
Leistungsfaktor Betriebsgerät	0,9
Temperaturschutz	110°C
Anzahl Sekundärausgänge	1

Variante	Art. Nr.
<input type="checkbox"/> weiß	1002791

Hersteller: HEP GmbH

LED TREIBER 350mA | 10W

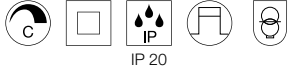

220-240V ~50/60Hz
L: 8,5 cm B: 4,1 cm H: 2,2 cm
Material: Polycarbonat (PC)

Ausgangsspannung	13-26V DC
Leistung von	4,55W
Leistung bis	9,1W
Leistungsfaktor Betriebsgerät	0,9
Temperaturschutz	110°C
Anzahl Sekundärausgänge	1

Variante	Art. Nr.
<input type="checkbox"/> weiß	464140

Hersteller: HEP GmbH

LED TREIBER 350mA | 15W

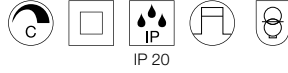

220-240V ~50/60Hz
L: 8,5 cm B: 4,1 cm H: 2,2 cm
Material: Polycarbonat (PC)

Ausgangsspannung	26-43
Leistung von	9W
Leistung bis	15W
Leistungsfaktor Betriebsgerät	0,9
Temperaturschutz	110°C
Anzahl Sekundärausgänge	1

Variante	Art. Nr.
<input type="checkbox"/> weiß	1002803

Hersteller: HEP GmbH

LED TREIBER 350mA | 20W

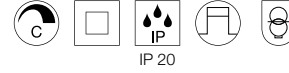

220-240V ~50/60Hz
L: 11,5 cm B: 4,1 cm H: 2,5 cm
Material: Polycarbonat (PC)

Ausgangsspannung	32-54V DC
Leistung von	11,2W
Leistung bis	18,9W
Leistungsfaktor Betriebsgerät	0,9
Temperaturschutz	110°C
Anzahl Sekundärausgänge	1

Variante	Art. Nr.
<input type="checkbox"/> weiß	1005449

Hersteller: HEP GmbH

LED TREIBER 500mA | 15W

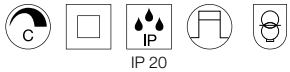

220-240V ~50/60Hz
L: 8,5 cm B: 4,1 cm H: 2,2 cm
Material: Polycarbonat (PC)

Ausgangsspannung	18-30V DC
Leistung von	9W
Leistung bis	15W
Leistungsfaktor Betriebsgerät	0,9
Temperaturschutz	110°C
Anzahl Sekundärausgänge	1

Variante	Art. Nr.
<input type="checkbox"/> weiß	464144

Hersteller: HEP GmbH

LED TREIBER 700mA | 10W

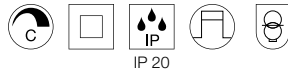

220-240V ~50/60Hz
L: 8,5 cm B: 4,1 cm H: 2,2 cm
Material: Polycarbonat (PC)

Ausgangsspannung	13-26V DC
Leistung von	4,55W
Leistung bis	9,1W
Leistungsfaktor Betriebsgerät	0,9
Temperaturschutz	110°C
Anzahl Sekundärausgänge	1

Variante	Art. Nr.
<input type="checkbox"/> weiß	464142

Hersteller: HEP GmbH

LED TREIBER 700mA | 6W

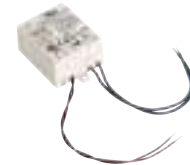

220-240V ~50/60Hz
L: 6,3 cm B: 4 cm H: 2,3 cm
Material: Polycarbonat (PC)

Ausgangsspannung	4,8-8,6V DC
Leistung von	3,4W
Leistung bis	6W
Leistungsfaktor Betriebsgerät	0,9
Temperaturschutz	110°C
Anzahl Sekundärausgänge	1

Variante	Art. Nr.
<input type="checkbox"/> weiß	1002792

Hersteller: HEP GmbH

LED TREIBER
700mA | 20W | dimmbar |
inkl. Zulentlastung



220-240V ~50/60Hz
L: 11,5 cm B: 4,1 cm H: 2,5 cm
Material: Polycarbonat (PC)

Ausgangsspannung	18-26V DC
Leistung von	12,6W
Leistung bis	182W
Leistungsfaktor Betriebsgerät	0,9
Temperaturschutz	110°C
Anzahl Sekundärausgänge	1

Variante	Art. Nr.
<input type="checkbox"/> weiß	1006202

Hersteller: HEP GmbH

LED TREIBER
700mA | 39W inkl. Zulentlastung

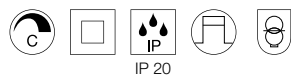

220-240V ~50/60Hz
L: 16,6 cm B: 5,2 cm H: 2,4 cm
Material: Polycarbonat (PC)

Ausgangsspannung	28-56V DC
Leistung von	20W
Leistung bis	39W
Leistungsfaktor Betriebsgerät	0,95
Temperaturschutz	110°C
Anzahl Sekundärausgänge	1

Variante	Art. Nr.
<input checked="" type="checkbox"/> grau / blau	1001267

LED TREIBER
700mA | 40W

FOLLOWER



220-240V ~50/60Hz
L: 14,5 cm B: 4 cm H: 3 cm
Material: Polycarbonat (PC)

Ausgangsspannung	32-54V DC
Leistung von	22,4W
Leistung bis	37,8W
Leistungsfaktor Betriebsgerät	0,9
Temperaturschutz	110°C
Anzahl Sekundärausgänge	1

Variante	Art. Nr.
<input type="checkbox"/> weiß <input checked="" type="checkbox"/>	1005446

Hersteller: HEP GmbH

LED TREIBER
1000mA | 39W inkl. Zulentlastung

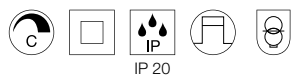

220-240V ~50/60Hz
L: 16,6 cm B: 5,2 cm H: 2,4 cm
Material: Polycarbonat (PC)

Ausgangsspannung	28-56V DC
Leistung von	20W
Leistung bis	39W
Leistungsfaktor Betriebsgerät	0,95
Temperaturschutz	110°C
Anzahl Sekundärausgänge	1

Variante	Art. Nr.
<input type="checkbox"/> weiß	464804

LED TREIBER
1000mA | 40W

FOLLOWER



200-240V ~50/60Hz
L: 14,5 cm B: 4 cm H: 3 cm
Material: Polycarbonat (PC)

Ausgangsspannung	25-40V DC
Leistung von	26,3W
Leistung bis	42W
Leistungsfaktor Betriebsgerät	0,9
Temperaturschutz	110°C
Anzahl Sekundärausgänge	1

Variante	Art. Nr.
<input type="checkbox"/> weiß <input checked="" type="checkbox"/>	1005387

Hersteller: HEP GmbH

LED TREIBER

250-700mA | 20W inkl. Zugentlastung



220-240V ~50/60Hz
L: 15 cm B: 5,2 cm H: 2,8 cm
Material: Polycarbonat (PC)

Ausgangsspannung	6-60V DC
Leistung von	1,5W
Leistung bis	20W
Leistungsfaktor Betriebsgerät	0,9
Temperaturschutz	110°C
Anzahl Sekundärausgänge	1

Variante	Art. Nr.
<input type="checkbox"/> weiß	1002423

Hersteller: HEP GmbH

LED TREIBER

250-700mA | 40W inkl. Zugentlastung



220-240V ~50/60Hz
L: 12,3 cm B: 7,9 cm H: 2,4 cm
Material: Polycarbonat (PC)

Ausgangsspannung	9-58V DC
Leistung von	4,5W
Leistung bis	40W
Leistungsfaktor Betriebsgerät	0,9
Temperaturschutz	110°C
Anzahl Sekundärausgänge	1

Variante	Art. Nr.
<input type="checkbox"/> weiß	1002424

Hersteller: HEP GmbH

LED TREIBER

700-1500mA | 50W inkl. Zugentlastung



220-240V ~50/60Hz
L: 12,3 cm B: 7,9 cm H: 2,4 cm
Material: Polycarbonat (PC)

Ausgangsspannung	6-58V DC
Leistung von	4,2W
Leistung bis	50W
Leistungsfaktor Betriebsgerät	0,9
Temperaturschutz	110°C
Anzahl Sekundärausgänge	1

Variante	Art. Nr.
<input type="checkbox"/> weiß	1002425

Hersteller: HEP GmbH

LED TREIBER

250mA | 10 W



220-240V ~50/60Hz
L: 6,5 cm B: 3,9 cm H: 2 cm
Material: Polycarbonat (PC)

Ausgangsspannung	26-40V DC
Leistung von	6,5W
Leistung bis	10W
Leistungsfaktor Betriebsgerät	0,9
Temperaturschutz	110°C
Anzahl Sekundärausgänge	1

Variante	Art. Nr.
<input type="checkbox"/> weiß	1004780

Hersteller: HEP GmbH

LED TREIBER

320mA | 3W inkl. Zugentlastung



220-240V ~50/60Hz
L: 5,5 cm B: 3,9 cm H: 2 cm
Material: Polycarbonat (PC)

Ausgangsspannung	3-9V DC
Leistung von	1W
Leistung bis	3W
Leistungsfaktor Betriebsgerät	0,4
Temperaturschutz	110°C
Anzahl Sekundärausgänge	1

Variante	Art. Nr.
<input type="checkbox"/> weiß	464108

Hersteller: HEP GmbH

LED TREIBER
350mA | 3W inkl. Zulentlastung

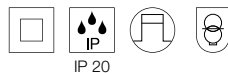

220-240V ~50/60Hz
L: 5,6 cm B: 3,9 cm H: 2 cm
Material: Polycarbonat (PC)

- inkl. AMP Stecker 350mA

Ausgangsspannung	3-9V DC
Leistung von	1W
Leistung bis	3,6W
Leistungsfaktor Betriebsgerät	0,4
Temperaturschutz	110°C
Anzahl Sekundärausgänge	1

Variante	Art. Nr.
<input type="checkbox"/> weiß	464107

Hersteller: HEP GmbH

LED TREIBER
350mA | 15W inkl. Zulentlastung

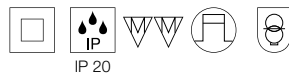

220-240V ~50/60Hz
L: 15,8 cm B: 2,2 cm H: 1,9 cm
Material: Polycarbonat (PC)

Ausgangsspannung	2-40V DC
Leistung von	0W
Leistung bis	15W
Leistungsfaktor Betriebsgerät	0,6
Temperaturschutz	100°C
Anzahl Sekundärausgänge	1

Variante	Art. Nr.
<input type="checkbox"/> weiß	464031

Hersteller: TCI Telecomunicazioni Italia Srl

LED TREIBER
350mA | 20W inkl. Zulentlastung

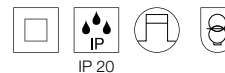

220-240V ~50/60Hz
L: 11,64 cm B: 4,4 cm H: 3 cm
Material: Kunststoff

Leistung von	12,6W
Leistung bis	19,5W
Leistungsfaktor Betriebsgerät	0,9
Temperaturschutz	110°C

Variante	Art. Nr.
<input type="checkbox"/> weiß	1002420

Hersteller: HEP GmbH

LED TREIBER
500mA | 10W inkl. Zulentlastung

FOLLOWER



220-240V ~50/60Hz
L: 6,5 cm B: 3,9 cm H: 2 cm
Material: Polycarbonat (PC)

Ausgangsspannung	13-20V DC
Leistung von	6,5W
Leistung bis	10W
Leistungsfaktor Betriebsgerät	0,9
Temperaturschutz	110°C
Anzahl Sekundärausgänge	1

Variante	Art. Nr.
<input type="checkbox"/> weiß	1005384 ■

Hersteller: HEP GmbH

LED TREIBER
700mA | 3W inkl. Zulentlastung

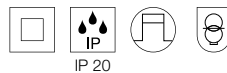

220-240V ~50/60Hz
L: 5,5 cm B: 3,9 cm H: 2 cm
Material: Polycarbonat (PC)

Ausgangsspannung	4-5Vdc
Leistung von	3W
Leistung bis	3W
Leistungsfaktor Betriebsgerät	0,4
Temperaturschutz	110°C
Anzahl Sekundärausgänge	1

Variante	Art. Nr.
<input type="checkbox"/> weiß	464200

Hersteller: HEP GmbH

LED TREIBER
500/600/700mA |
30W inkl. Zulentlastung



220-240V ~50/60Hz
L: 14,7 cm B: 4,3 cm H: 3 cm
Material: Polycarbonat (PC)

Ausgangsspannung	30-42V DC
Leistung von	21W
Leistung bis	29,5W
Leistungsfaktor Betriebsgerät	0,9
Temperaturschutz	110°C
Anzahl Sekundärausgänge	1

Variante	Art. Nr.
<input type="checkbox"/> weiß	1004781

Hersteller: HEP GmbH

LED TREIBER
800/900/1050mA |
40W inkl. Zulentlastung



220-240V ~50/60Hz
L: 14,7 cm B: 4,3 cm H: 3 cm
Material: Polycarbonat (PC)

LED TREIBER
700/90/100mA |
40W inkl. Zulentlastung

FOLLOWER



120-277V ~50/60Hz
L: 12,3 cm B: 7,9 cm H: 3 cm
Material: Polycarbonat (PC)

LED TREIBER
1000mA | 60W inkl. Zulentlastung

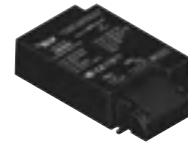

220-240V ~50/60Hz

Ausgangsspannung	30-42V DC
Leistung von	31,5W
Leistung bis	44W
Leistungsfaktor Betriebsgerät	0,9
Temperaturschutz	110°C
Anzahl Sekundärausgänge	1

Ausgangsspannung	28-52V DC
Leistung von	19,6W
Leistung bis	40W
Leistungsfaktor Betriebsgerät	0,9
Temperaturschutz	110°C
Anzahl Sekundärausgänge	3

Ausgangsspannung	28-57V DC
Leistung von	28W
Leistung bis	57W
Leistungsfaktor Betriebsgerät	0,9
Temperaturschutz	110°C
Anzahl Sekundärausgänge	1

Variante	Art. Nr.
<input type="checkbox"/> weiß	1004782

Hersteller: HEP GmbH

Variante	Art. Nr.
<input type="checkbox"/> weiß	1006120 ■

Hersteller: HEP GmbH

Variante	Art. Nr.
<input checked="" type="checkbox"/> schwarz	1002422

Hersteller: HEP GmbH

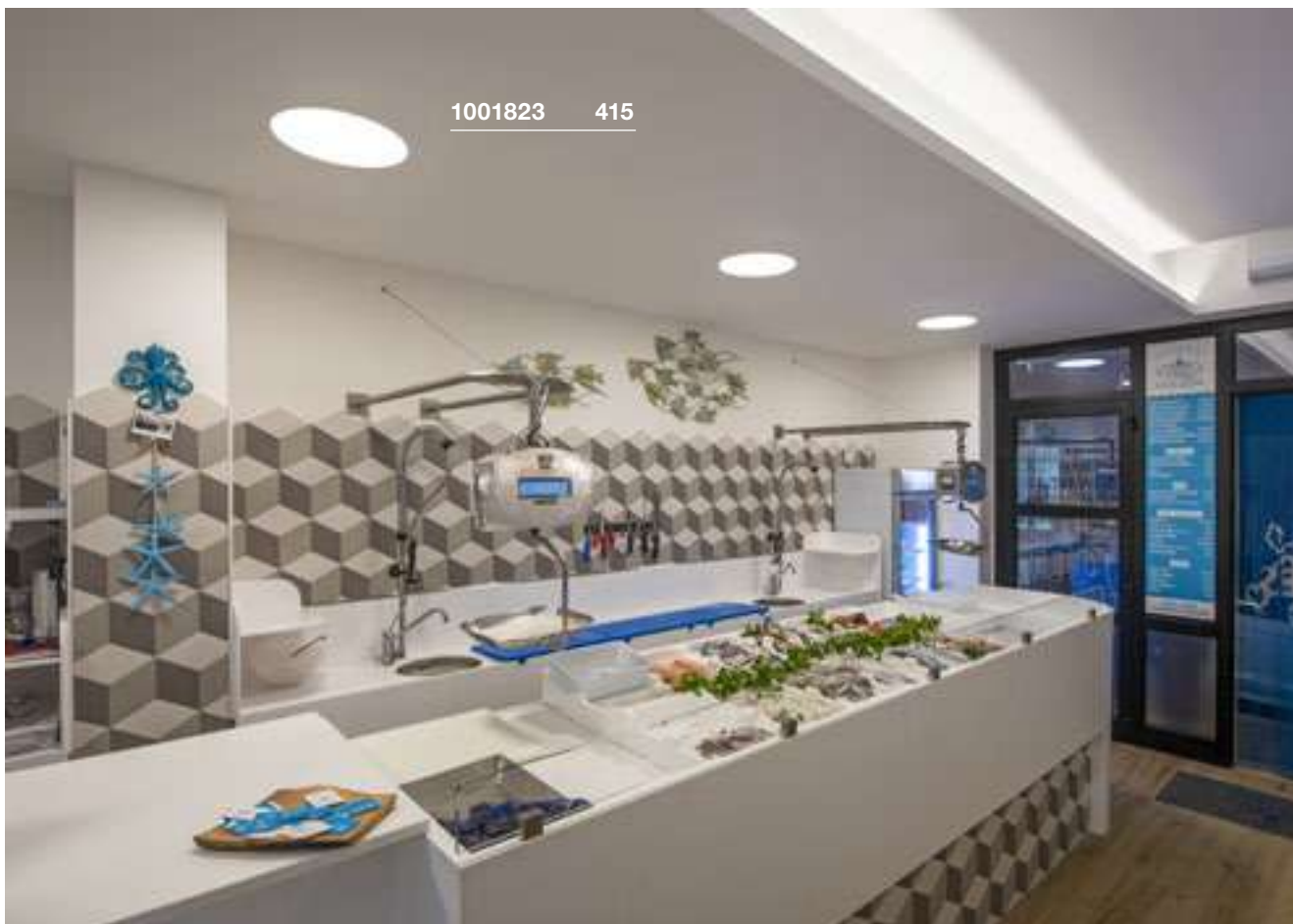

1001823 415

DECKENHAKEN



L: 4,6 cm Ø: 1,8 cm
Material: Aluminium

KABELKLEMME



L: 3,1 cm Ø: 1,4 cm
Material: Aluminium

GLENOS®
Deckenrosette



230V ~50Hz
L: 8,5 cm B: 8,5 cm H: 2,7 cm
Material: Aluminium

Nennspannung	230V ~50Hz
Strombelastung max.	8,5A

Variante	Art. Nr.
■ schwarz	132670
□ weiß	132671

Variante	Art. Nr.
■ schwarz	132680
□ weiß	132681

Variante	Art. Nr.
■ schwarz	210060
□ weiß	210061
■ grau	210064

TEXTILKABEL
10m



L: 1000 cm Ø: 0,6 cm
Material: Polyvinylchlorid (PVC) / Textil

KABEL
3-polig, 3 x 0,75 mm², 10 m



L: 1000 cm

DRAHTSEILABHÄNGUNG

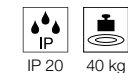

L: 500 cm Ø: 0,15 cm
Material: Stahl / Kunststoff

- inkl. 3 Kabelclips

Spannung max.	300V
---------------	------

Spannung max.	300V
---------------	------

Variante	Art. Nr.
■ schwarz	961270
□ weiß	961271
■ rot	961276

Variante	Art. Nr.
■ silber	961250

Variante	Art. Nr.
■ silber	961037

Hersteller: Reutlinger GmbH

STOPPER FÜR DRAHTSEIL



Ø: 0,8 cm
Material: Stahl

KABELVERLÄNGERUNG



L: 100 cm
Material: Kunststoff

- Mit AMP Stecker und Kupplung

Strombelastung max. 350mA

STECKERLEISTE
3 Ausgänge

L: 5,2 cm B: 1,4 cm H: 1,3 cm
Material: Kunststoff

Strombelastung max. 350mA

Variante	Art. Nr.
■ grau	961034

Variante	Art. Nr.
■ schwarz / rot	111861

Variante	Art. Nr.
■ schwarz	111850

DOPPELSEITIGES
KLEBEBAND

L: 300 cm B: 0.9 cm

GU10 FASSUNG



230V ~50Hz
H: 1.6 cm
Ø: 2.8 cm
Material: Keramik

Nennspannung 220-240V
~50/60Hz

Variante	Art. Nr.
□ transparent	220000

Variante	Art. Nr.
□ weiß	955135

GU10 FASSUNG
mit Anschlussbox und Schnellklemme

L: 27 cm

Variante	Art. Nr.
■ weiß / schwarz	1000909

VERBINDUNGSBOX 5-polig



220-240V ~50/60Hz
L: 13 cm Ø: 3,2 cm
Material: Polyamid (PA)

VERBINDUNGSBOX IP68, 3-polig



220-240V ~50/60Hz
L: 11,5 cm Ø: 2,7 cm
Material: Polyamid (PA)

T-VERBINDERBOX 3-polig



220-240V ~50/60Hz
L: 11 cm B: 6,4 cm H: 3 cm
Material: Polyamid (PA)

Spannung max.	450V
Strombelastung max.	32A

Spannung max.	450V
Strombelastung max.	17,5A

Spannung max.	500V
Strombelastung max.	17,5A

Variante	Art. Nr.
■ schwarz	228725

Variante	Art. Nr.
■ schwarz	228730

Variante	Art. Nr.
■ schwarz	228726



1001823 527

NEW

ZEIT FÜR VERÄNDERUNG. ZEIT FÜR EIN UPDATE.

Eine veraltete, oft noch mit konventionellen Leuchtmitteln ausgestattete Deckeneinbauleuchte soll einer energieeffizienten und kostensparenden Alternative weichen. Bei der Demontage finden Sie dabei häufig einen größeren Deckenausschnitt vor als benötigt.

Hier bietet SLV die passende Lösung – unsere neuen Reduzierringe.

Die Reduzierringe decken den größeren Deckenausschnitt komplett ab und geben gleichzeitig Ihrer neuen, kompakten Deckeneinbauleuchte perfekten Halt.

Sauber, zeitsparend, unkompliziert.

Und dabei perfekt abgestimmt auf das NUMINOS® Down – und Spotlightsystem.



1. Alte Deckeneinbauleuchte mit größerem Deckenausschnitt.



2. Deinstallation der alten Deckeneinbauleuchte.



3. Einsetzen des Reduzierrings.



4. Reduzierring eingebaut. Größerer Deckenausschnitt gänzlich abgedeckt.



5. Elektrischer Anschluss und Installation der neuen Deckeneinbauleuchte.



6. Neue Deckeneinbauleuchte in Reduzierring platziert.





Reduzierring rund



Material	Stahl	Stahl	Stahl	Stahl	Stahl
Außen-Ø	16 cm	16 cm	24 cm	24 cm	24 cm
Höhe	5,3 cm	5,3 cm	5,3 cm	5,3 cm	5,3 cm
Innen-Ø	7 cm	9 cm	12 cm	15 cm	18 cm
Deckenausschnitt	8,5 - 13 cm	12 - 15 cm	14 - 18 cm	17 - 20 cm	20 - 22 cm
Materialdicke	3 cm	3 cm	3 cm	3 cm	3 cm
Art. Nr. schwarz	1006135	1006139	1006143	1006147	1006151
Art. Nr. weiß	1006136	1006140	1006144	1006148	1006152

Reduzierring eckig



Material	Stahl	Stahl	Stahl	Stahl	Stahl
Länge	16 cm	16 cm	24 cm	24 cm	24 cm
Breite	16 cm	16 cm	24 cm	24 cm	24 cm
Höhe	5,3 cm	5,3 cm	5,3 cm	5,3 cm	5,3 cm
Innen-Ø	7 cm	9 cm	12 cm	15 cm	18 cm
Deckenausschnitt	8,5 - 13 cm	12 - 15 cm	14 - 18 cm	17 - 20 cm	20 - 22 cm
Materialdicke	3 cm	3 cm	3 cm	3 cm	3 cm
Art. Nr. schwarz	1006137	1006141	1006145	1006149	1006153
Art. Nr. weiß	1006138	1006142	1006146	1006150	1006154

DIE QUELLE ALLEN LICHTS.

FÜR JEDE LICHTLÖSUNG DAS RICHTIGE LEUCHTMITTEL.

Die richtige Lichtwirkung ist das Ergebnis eines perfekten Zusammenspiels von Leuchte und Leuchtmittel. Neben der Bauform ist auch die Energieeffizienz ein wichtiges Kriterium. In den letzten Jahren hat eine Vielzahl von Alternativen zur klassischen Glühlampe in den Markt Einzug gehalten. So findet sich für jeden Anwendungs- und Leuchtentyp das passende Leuchtmittel.

LEUCHTMITTEL

ALLGEMEINE INFORMATIONEN.

- Der Betrieb bei offenen Leuchten ohne Schutzglas ist nur mit Niederdrucklampen zulässig. Leuchtmittel mit diesem Zeichen (Norm IEC 357) sind für den Einsatz in Leuchten ohne Schutzglas geeignet.
- Halogenleuchtmittel und Metaldampfentladungslampen (HID) können zur Aufheizung des jeweiligen Leuchtgehäuses führen. Letzteres darf daher nur im abgekühlten Zustand berührt werden. Verstellbare Leuchten bzw. Leuchtenköpfe, die nicht über Verstellgriffe verfügen oder die bei Betrieb mit der maximalen Leuchtmittleistung die maximal zulässige Gehäusestemperatur an der offensichtlichen Verstellstelle übersteigen, sind zudem außerhalb des Handbereichs zu montieren. Entsprechende Lösungen finden Sie in diesem Kapitel.
- Auch Niedervolt-Leuchten können in vielen Fällen mit passenden LED-Retrofit-Leuchtmitteln betrieben werden. Aufgrund der im Einzelfall aufeinandertreffenden, jeweils spezifischen Trafo- und LED-Technik ist jedoch nicht jede Kombination von Leuchten mit augenscheinlich passenden Leuchtmitteln möglich. Bei Fragen zur Kompatibilität finden Sie Informationen unter slv.com oder wenden Sie sich an unsere Verkaufsabteilung.
- Die Maßangaben der Leuchtmittel beziehen sich immer auf die kompletten Außenmaße eines Leuchtmittels. Das bedeutet inklusive Gewindefassung.
- **Alle Lampen sind gesondert zu entsorgen und gehören nicht in den Hausmüll.**



LED QT14
G9

NEW

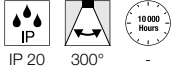

220-240V ~50/60Hz
Leistung: 3,6W
Material: Keramik
Ø: 1,8 cm H: 5,4 cm

Lichtstrom	400lm
Lampenstrom	0,03A
Farbwiedergabeindex	90
Leistung	3,6W
Energieverbrauch/1000h	4kWh



Variante	Art. Nr.
<input type="checkbox"/> weiß 3000K	1005286

LED QT-DE12
R7S, 78 mm

NEW



220-240V ~50/60Hz
Leistung: 9W
Material: Polycarbonat (PC)
Ø: 2,9 cm L: 7,8 cm

Lichtstrom	1050lm
Lampenstrom	0,043A
Farbwiedergabeindex	90
Leistung	9W
Energieverbrauch/1000h	9kWh



Variante	Art. Nr.
<input type="checkbox"/> grau 3000K	1005287

LED QT-DE12
R7S, 118 mm

NEW



220-240V ~50/60Hz
Leistung: 15W
Material: Polycarbonat (PC)
Ø: 2,9 cm L: 11,8 cm

Lichtstrom	2000lm
Lampenstrom	0,068A
Farbwiedergabeindex	90
Leistung	15W
Energieverbrauch/1000h	15kWh



Variante	Art. Nr.
<input type="checkbox"/> grau 3000K	1005288

LED C35
E14

NEW

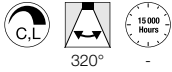

220-240V ~50/60Hz
Leistung: 4,2W
Material: Glas
Ø: 3,5 cm H: 9,8 cm

Lichtstrom	380lm
Lampenstrom	0,025A
Farbwiedergabeindex	90
Leistung	4,2W
Energieverbrauch/1000h	5kWh



Variante	Art. Nr.
<input type="checkbox"/> transparent 2700K	1005284

LED C35
E14

NEW



220-240V ~50/60Hz
Leistung: 4,2W
Material: Glas
Ø: 3,5 cm H: 9,8 cm

Lichtstrom	350lm
Lampenstrom	0,025A
Farbwiedergabeindex	90
Leistung	4,2W
Energieverbrauch/1000h	5kWh



Variante	Art. Nr.
<input type="checkbox"/> weiß 2700K	1005285

LED TCR-TSE
GX53

NEW

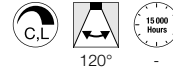

220-240V ~50/60Hz
Leistung: 6,1W
Material: Polycarbonat (PC) / Polycarbonat (PC)
Ø: 7,5 cm H: 2,4 cm

Lichtstrom	490lm
Lampenstrom	0,034A
Farbwiedergabeindex	90
Leistung	6,1W
Energieverbrauch/1000h	6kWh



1005272
1005271



1005269

Variante	Art. Nr.
<input type="checkbox"/> weiß / milchig 2700K	1005272
<input type="checkbox"/> weiß / milchig 3000K	1005271
<input type="checkbox"/> weiß / milchig 4000K	1005269

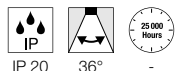
LED QR51
GU5,3

12V AC
Leistung: 5,5W
Material: Glas
Ø: 5 cm L: 4,5 cm

Lichtstrom	450lm
Lampenstrom	0,63A
max. Lichtstärke	1000cd
Farbwiedergabeindex	80
Leistung	5,5W
Energieverbrauch/1000h	7kWh

1001574 1001575

Variante	Art. Nr.
transparent 2700K	1001574
transparent 3000K	1001575

Hersteller: Signify B.V.

LED G53



12V AC
Leistung: 15W
Material: Kunststoff / Aluminium
Ø: 11,1 cm L: 6,2 cm

Lichtstrom	760lm
Lampenstrom	1,8A
max. Lichtstärke	3900cd
Farbwiedergabeindex	90
Leistung	15W
Energieverbrauch/1000h	17kWh

Variante	Art. Nr.
silber 2700K	560231
silber 3000K	560233

Hersteller: Signify B.V.

LED G53



12V AC
Leistung: 15W
Material: Kunststoff / Aluminium
Ø: 11,1 cm L: 6,2 cm

Lichtstrom	800lm
Lampenstrom	1,8A
max. Lichtstärke	1400cd
Farbwiedergabeindex	90
Leistung	15W
Energieverbrauch/1000h	17kWh

Variante	Art. Nr.
silber 2700K	560232
silber 3000K	560234

Hersteller: Signify B.V.

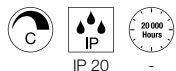
LED T32 FILAMENT
GU10

220-240V ~50/60Hz
Leistung: 3,2W
Material: Glas
Ø: 3,2 cm L: 10 cm

Lichtstrom	270lm
Lampenstrom	0,0175A
Farbwiedergabeindex	90
Leistung	3,2W
Energieverbrauch/1000h	4kWh

Variante	Art. Nr.
transparent 2700K	1003101

Hersteller: Segula GmbH

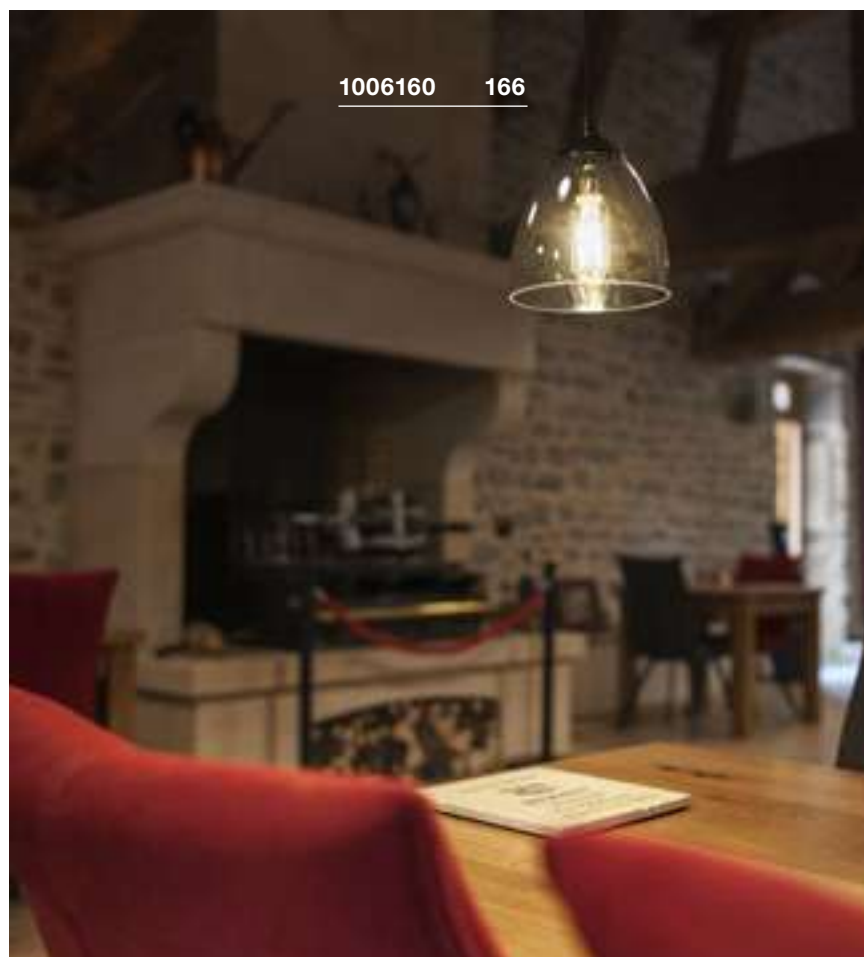

LED QPAR51
GU10, tunable 2700-6500K, smart

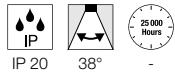

220-240V ~50/60Hz
Leistung: 5W
Material: Polyamid 66 (PA 66) / Polycarbonat (PC)
Ø: 5 cm H: 5,4 cm

Lichtstrom	380lm
Lampenstrom	0,04A
max. Lichtstärke	530cd
Farbwiedergabeindex	90
Leistung	5W
Energieverbrauch/1000h	5kWh



Variante	Art. Nr.
<input type="checkbox"/> weiß 2700-6500K	1005311

LED QPAR51
GU10, RGBW, smart



220-240V ~50/60Hz
Leistung: 5,2W
Material: Polyamid 66 (PA 66) / Polycarbonat (PC)
Ø: 5 cm H: 6,1 cm

Lichtstrom	370lm
Lampenstrom	0,042A
max. Lichtstärke	680cd
Farbwiedergabeindex	90
Leistung	5,2W
Energieverbrauch/1000h	6kWh



Variante	Art. Nr.
<input type="checkbox"/> weiß	1005312

LED QPAR51
GU10

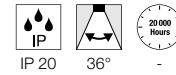

220-240V ~50/60Hz
Leistung: 4W
Material: Kunststoff
Ø: 5 cm L: 5,5 cm

• Enthält recyceltes Material

Lichtstrom	270lm
Lampenstrom	0,035A
max. Lichtstärke	400cd
Farbwiedergabeindex	80
Leistung	4W
Energieverbrauch/1000h	4kWh



Variante	Art. Nr.
<input type="checkbox"/> weiß 2700K	1004972
<input type="checkbox"/> weiß 3000K	1004973
<input type="checkbox"/> weiß 4000K	1004974

LED QPAR51
GU10

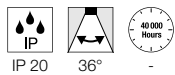

220-240V ~50/60Hz
Leistung: 6W
Material: Glas
Ø: 5 cm L: 5,4 cm

Lichtstrom	360lm
Lampenstrom	0,033A
max. Lichtstärke	680cd
Farbwiedergabeindex	90
Leistung	6W
Energieverbrauch/1000h	6kWh



Variante	Art. Nr.
<input type="checkbox"/> silber 2200-2700K	1005273



LED QPAR51
GU10

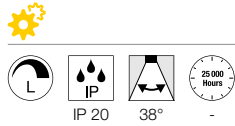

220-240V ~50/60Hz
Leistung: 6W
Material: Polycarbonat (PC)
Ø: 5 cm L: 5,4 cm

Lichtstrom	450lm
Lampenstrom	0,037A
max. Lichtstärke	880cd
Farbwiedergabeindex	90
Leistung	6W
Energieverbrauch/1000h	6kWh

A G **G** 1005077 **A G** **F** 1005080
1005083

Variante	Art. Nr.
■ schwarz 2700K	1005077
■ schwarz 3000K	1005080
■ schwarz 4000K	1005083

LED QPAR51
GU10

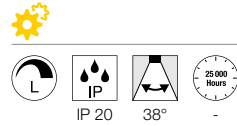

220-240V ~50/60Hz
Leistung: 6W
Material: Polycarbonat (PC)
Ø: 5 cm L: 5,4 cm

Lichtstrom	450lm
Lampenstrom	0,037A
max. Lichtstärke	880cd
Farbwiedergabeindex	90
Leistung	6W
Energieverbrauch/1000h	6kWh

A G **G** 1005076 **A G** **F** 1005079
1005082

Variante	Art. Nr.
□ weiß 2700K	1005076
□ weiß 3000K	1005079
□ weiß 4000K	1005082

LED QPAR51
GU10

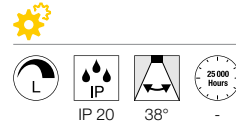

220-240V ~50/60Hz
Leistung: 6W
Material: Polycarbonat (PC)
Ø: 5 cm L: 5,4 cm

Lichtstrom	450lm
Lampenstrom	0,037A
max. Lichtstärke	880cd
Farbwiedergabeindex	90
Leistung	6W
Energieverbrauch/1000h	6kWh

A G **G** 1005075 **A G** **F** 1005078
1005081

Variante	Art. Nr.
■ grau 2700K	1005075
■ grau 3000K	1005078
■ grau 4000K	1005081

QPAR111
GU10, tunable 2700-6500K, smart

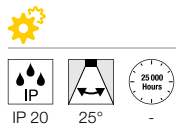

220-240V ~50/60Hz
Leistung: 10W
Material: Aluminium / Polycarbonat (PC)
Ø: 11,1 cm H: 7 cm

Lichtstrom	760lm
Lampenstrom	0,051A
max. Lichtstärke	4300cd
Farbwiedergabeindex	90
Leistung	10W
Energieverbrauch/1000h	10kWh

A G **F**

Variante	Art. Nr.
□ weiß 2700-6500K	1005313 ■
□ weiß 2700-6500K	1005314 ■

LED QPAR111
GU10, RGBW, smart

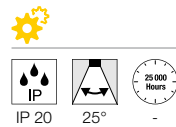

220-240V ~50/60Hz
Leistung: 10W
Material: Aluminium
Ø: 11,1 cm H: 7 cm

Lichtstrom	750lm
Lampenstrom	0,056A
max. Lichtstärke	3500cd
Farbwiedergabeindex	90
Leistung	10W
Energieverbrauch/1000h	10kWh

A G **F**

Variante	Art. Nr.
□ weiß	1005315 ■

LED QPAR111
GU10, RGBW, smart

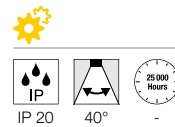

220-240V ~50/60Hz
Leistung: 10W
Material: Aluminium
Ø: 11,1 cm H: 7 cm

Lichtstrom	790lm
Lampenstrom	0,056A
max. Lichtstärke	3500cd
Farbwiedergabeindex	90
Leistung	10W
Energieverbrauch/1000h	10kWh

A G **F**

Variante	Art. Nr.
□ weiß	1005316 ■

LED QPAR 111
GU10

NEW

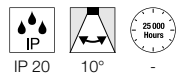

220-240V ~50/60Hz
Leistung: 12,5W
Material: Aluminium
Ø: 11,1 cm H: 7 cm

Lichtstrom	900lm
Lampenstrom	0,058A
max. Lichtstärke	11000cd
Farbwiedergabeindex	90
Leistung	12,5W
Energieverbrauch/1000h	13kWh



Variante	Art. Nr.
silber 2700K	1005275
silber 3000K	1005278
silber 4000K	1005281

LED QPAR 111
GU10

NEW



220-240V ~50/60Hz
Leistung: 12,5W
Material: Aluminium
Ø: 11,1 cm H: 7 cm

Lichtstrom	950lm
Lampenstrom	0,058A
max. Lichtstärke	3000cd
Farbwiedergabeindex	90
Leistung	12,5W
Energieverbrauch/1000h	13kWh



Variante	Art. Nr.
silber 2700K	1005276
silber 3000K	1005279
silber 4000K	1005282

LED QPAR 111
GU10

NEW

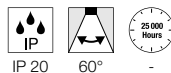

220-240V ~50/60Hz
Leistung: 12,5W
Material: Aluminium
Ø: 11,1 cm H: 7 cm

Lichtstrom	1000lm
Lampenstrom	0,058A
max. Lichtstärke	1000cd
Farbwiedergabeindex	90
Leistung	12,5W
Energieverbrauch/1000h	13kWh



1005277
1005280



1005283

Variante	Art. Nr.
silber 2700K	1005277
silber 3000K	1005280
silber 4000K	1005283

LED QPAR111
GU10

NEW

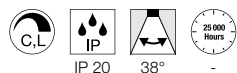

220-240V ~50/60Hz
Leistung: 8W
Material: Glas
Ø: 11,1 cm H: 6,1 cm

Lichtstrom	680lm
Lampenstrom	0,046A
max. Lichtstärke	1300cd
Farbwiedergabeindex	90
Leistung	8W
Energieverbrauch/1000h	8kWh



Variante	Art. Nr.
transparent 2700K	1005274

LED QPAR111
GU10

NEW

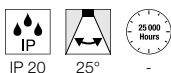

220-240V ~50/60Hz
Leistung: 7,3W
Material: Kunststoff / Aluminium
Ø: 11,1 cm H: 7,1 cm

Lichtstrom	530lm
Lampenstrom	0,051A
max. Lichtstärke	1470cd
Farbwiedergabeindex	90
Leistung	7,3W
Energieverbrauch/1000h	7kWh



Variante	Art. Nr.
silber 2700K	1005291
silber 3000K	1005292
silber 4000K	1005293

LED QPAR111
GU10

NEW



220-240V ~50/60Hz
Leistung: 7,3W
Material: Kunststoff / Aluminium
Ø: 11,1 cm H: 7,1 cm

Lichtstrom	500lm
Lampenstrom	0,051A
max. Lichtstärke	1040cd
Farbwiedergabeindex	90
Leistung	7,3W
Energieverbrauch/1000h	7kWh



Variante	Art. Nr.
silber 2700K	1005294
silber 3000K	1005295
silber 4000K	1005296

LED A60
E27, tunable 2700-6500K, smart



220-240V ~50/60Hz
Leistung: 9W
Material: Polyamid 66 (PA 66)
Ø: 6 cm H: 11 cm

Lichtstrom	800lm
Lampenstrom	0,067A
Farbwiedergabeindex	90
Leistung	9W
Energieverbrauch/1000h	9kWh



Variante	Art. Nr.
<input type="checkbox"/> weiß 2700-6500K	1005317

LED A60
E27, RGBW, smart



220-240V ~50/60Hz
Leistung: 9W
Material: Polyamid 66 (PA 66) / Polycarbonat (PC)
Ø: 6 cm H: 11 cm

Lichtstrom	800lm
Lampenstrom	0,073A
Farbwiedergabeindex	90
Leistung	9W
Energieverbrauch/1000h	9kWh



Variante	Art. Nr.
<input type="checkbox"/> weiß / milchig	1005318

LED A60
E27



220-240V ~50/60Hz
Leistung: 7,5W
Material: Glas
Ø: 6 cm H: 10,5 cm

Lichtstrom	700lm
Lampenstrom	0,038A
Farbwiedergabeindex	90
Leistung	7,5W
Energieverbrauch/1000h	8kWh



Variante	Art. Nr.
<input type="checkbox"/> gefrostet 2700K	1005304

LED A60
E27

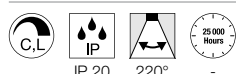

220-240V ~50/60Hz
Leistung: 9W
Material: Kunststoff
Ø: 6 cm H: 11 cm

Lichtstrom	800lm
Lampenstrom	0,048A
Farbwiedergabeindex	90
Leistung	9W
Energieverbrauch/1000h	9kWh



Variante	Art. Nr.
<input type="checkbox"/> weiß 2700K	1005301

LED A60
E27

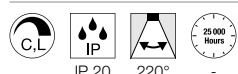

220-240V ~50/60Hz
Leistung: 9W
Material: Kunststoff
Ø: 6 cm H: 11 cm

Lichtstrom	1300lm
Lampenstrom	0,062A
Farbwiedergabeindex	90
Leistung	9W
Energieverbrauch/1000h	9kWh



Variante	Art. Nr.
<input type="checkbox"/> weiß 2700K	1005302

LED A60
E27



220-240V ~50/60Hz
Leistung: 7,5W
Material: Glas
Ø: 6 cm H: 10,5 cm

Lichtstrom	800lm
Lampenstrom	0,038A
Farbwiedergabeindex	90
Leistung	7,5W
Energieverbrauch/1000h	8kWh



Variante	Art. Nr.
<input type="checkbox"/> transparent 2700K	1005303

LED T38
E27

NEW

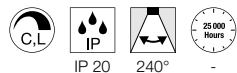

220-240V ~50/60Hz
Leistung: 8W
Material: Kunststoff
Ø: 3,8 cm H: 11,6 cm

Lichtstrom	880lm
Lampenstrom	0,035A
Farbwiedergabeindex	90
Leistung	8W
Energieverbrauch/1000h	8kWh



Variante	Art. Nr.
weiß 3000K	1005289
weiß 4000K	1005290

LED T45
E27

NEW

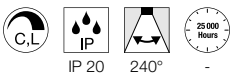

220-240V ~50/60Hz
Leistung: 13,5W
Material: Kunststoff
Ø: 4,5 cm H: 14 cm

Lichtstrom	1520lm
Lampenstrom	0,06A
Farbwiedergabeindex	90
Leistung	13,5W
Energieverbrauch/1000h	14kWh



Variante	Art. Nr.
weiß 3000K	1005307
weiß 4000K	1005308

LED ST64
E27

NEW



220-240V ~50/60Hz
Leistung: 7,5W
Material: Glas
Ø: 6,4 cm H: 14,5 cm

Lichtstrom	700lm
Lampenstrom	0,038A
Farbwiedergabeindex	90
Leistung	7,5W
Energieverbrauch/1000h	8kWh



Variante	Art. Nr.
gold 2500K	1005265

LED G95
E27

NEW



220-240V ~50/60Hz
Leistung: 7,5W
Material: Glas
Ø: 9,5 cm H: 13,8 cm

Lichtstrom	800lm
Lampenstrom	0,038A
Farbwiedergabeindex	90
Leistung	7,5W
Energieverbrauch/1000h	8kWh



Variante	Art. Nr.
transparent 2700K	1005309

LED A60
E27, Mirrorhead, Chrom

NEW

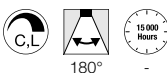

220-240V ~50/60Hz
Leistung: 7,5W
Material: Glas
Ø: 6 cm H: 10,5 cm

Lichtstrom	720lm
Lampenstrom	0,038A
Farbwiedergabeindex	90
Leistung	7,5W
Energieverbrauch/1000h	8kWh



Variante	Art. Nr.
chrom 2700K	1005305

LED ST58
E27

NEW



220-240V ~50/60Hz
Leistung: 7,5W
Material: Glas
Ø: 5,8 cm H: 14,2 cm

Lichtstrom	800lm
Lampenstrom	0,038A
Farbwiedergabeindex	90
Leistung	7,5W
Energieverbrauch/1000h	8kWh



Variante	Art. Nr.
transparent 2700K	1005268



LED G125
E27, Mirrorhead, Chrom

NEW



180°

220-240V ~50/60Hz
Leistung: 7,5W
Material: Glas
Ø: 12,5 cm H: 17,8 cm

Lichtstrom	720lm
Lampenstrom	0,038A
Farbwiedergabeindex	90
Leistung	7,5W
Energieverbrauch/1000h	8kWh



Variante	Art. Nr.
chrom 2700K	1005306 ■

1002146 109



EASY TO INSTALL.

Wenn wir von „Easy to Install“ sprechen, meinen wir durchdachte Features für mehr Effizienz. Bedeutet für Sie: Zeitsparende Installation für schnelle Projekt-
abwicklung, saubere Arbeit und zufriedene Kunden.

EINHÄGBARE LEUCHTENKÖPFE.

Bei unserer ENOLA® Familie lässt sich der Leuchtenkopf von der an der Wand fixierten Montageplatte trennen. So bleiben nach dem Einhängen über die integrierte Nase und dem elektrischen Anschluss via Steckverbinder beide Hände frei, um die Leuchte sicher anzuschrauben.



Praktische
Nase



Sicheres
Zusammenfügen



Zum Schluss
fixieren



EFFIZIENZ ZAHLT SICH AUS.

Weil sich Effizienz immer auszahlt, sind SLV Leuchten leicht, schnell und sicher zu installieren. Durch fixierte Montageplatten, einhängbare Leuchtenköpfe, Federklemmanschlüsse, Durchverdrahtungen, Kabeleinführungen und weitere Features bieten sie entscheidende Vorteile: Dass Sie Zeit, Aufwand und Kosten sparen.

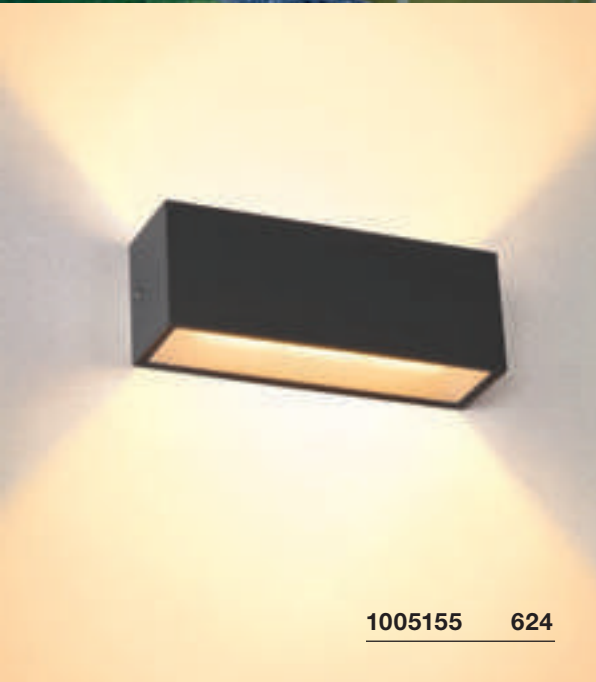

1005155 624

PRAKTISCHE FEDERKLEMMANSCHLÜSSE.

Die würfelförmigen SITRA CUBE Wandleuchten überzeugen durch moderne Schlichtheit. Dazu sind auch sie schnell und leicht installiert: Einfach die Anschlusskabel werkzeuglos und direkt anklemmen und die Kupplung der Montageplatte mit dem Stecker der Leuchte verbinden – fertig!

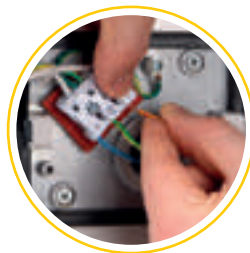

Anschluss
der Stromleitung



Einfach
zusammenstecken



NEW

1005202 675

DURCHGÄNGIG DURCHVERDRAHTET.

Unsere QUADRULO Wand- und Deckenleuchten zeigen, wie einfach die Durchverdrahtung in der Praxis funktioniert. Denn in der Grundplatte sind zwei Kabeleinführungen in 8er-Form vorgesehen. Auch die Federklemme besitzt zwei Anschlussmöglichkeiten. So lassen sich gleich mehrere Leuchten schnell und einfach installieren.



Sichere
Kabeleinführung

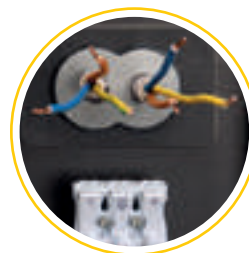

Durch und durch
verdrahtet

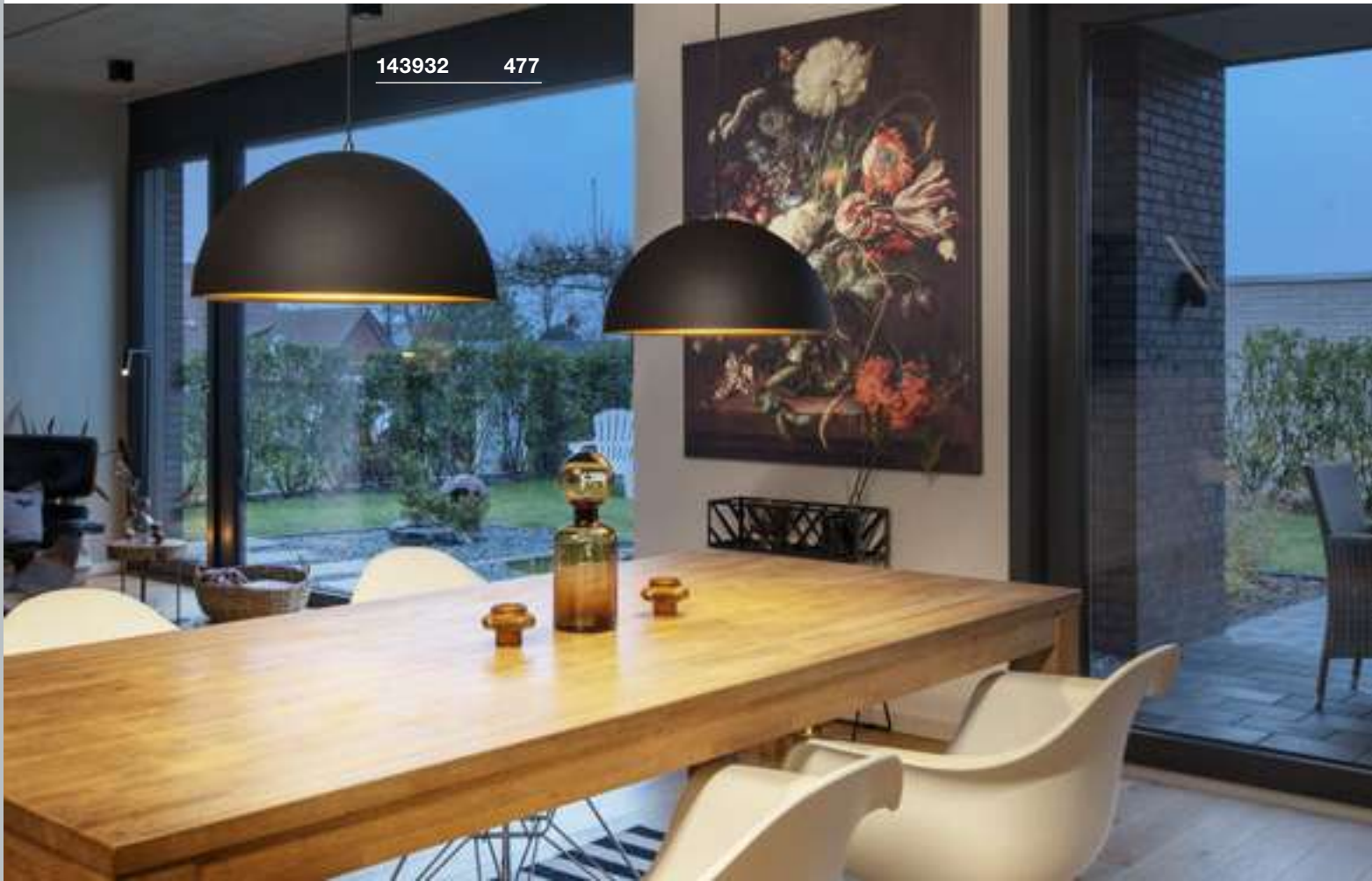

FAMILIENSACHE:

UNSERE SLV LEUCHTENFAMILIEN.



Gerade wenn eine optische Durchgängigkeit gewünscht ist, eignen sich unsere Leuchtenfamilien hervorragend, um verschiedene Räume oder Raumsituationen einheitlich zu gestalten und dabei trotzdem vielfältig zu bleiben.

ABRIDOR

Wege/Stand



576

Wege/Stand



576

Wand



650

Wand



650

ACCANTO

Pendel



156

Wand



221

Decke



279



ALTRA DICE

Wand 	Wand/Decke 	1Ph.-Stromschiene 	3Ph.-Stromschiene
274	308	485	453

ANELA

Pendel 	Decke
164	287

APONI

Wege/Stand 	Wege/Stand 	Wand
558	558	658

ASTINA

Pendel 	Wand 	Decke 	Wand 	Wand
160	217	287	641	641

AVO

Wand/Decke 	Wand/Decke 	Wand/Decke 	Wand/Decke 	3Ph.-Stromschiene 	1Ph.-Stromschiene
315	315	315	315	459	479

BIG NAILS

Wege/Stand 	Wand
560	660

BIMA

3Ph.-Stromschiene 	3Ph.-Stromschiene 	1Ph.-Stromschiene 	1Ph.-Stromschiene 	Easytec® II 	Easytec® II
456	456	482	482	492	492

BOOKAT

Wand 	Wand
	NEW
479	632



ENOLA

Pendel 	Wand 	Wand 	Wand 	Wand 	Wand 	Wand
161	611	611	611	612	612	612
Wand 	Wand 	Wand 	Wand 	Wand 	Wand 	
615	615	615	616	616	616	
Wand 	Wand 	Wand 	Wand 	Wand 	Wand 	
671	671	671	672	672	672	

ENOLA B

Pendel 	Wand 	Wand 	Decke 	Wand/Decke
161	217	217	281	307
Wand/Decke 	Wand/Decke 	1Ph.-Stromschiene 	1Ph.-Stromschiene 	
307	307	480	481	

ENOLA C

Decke 	Decke 	3Ph.-Stromschiene 	1Ph.-Stromschiene 	Wege/Stand
281	281	459	480	580



ESKINA



ESKINA FRAME



FENDA MIX & MATCH

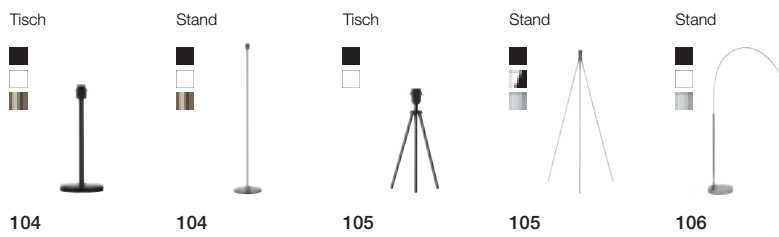

FITU MIX & MATCH

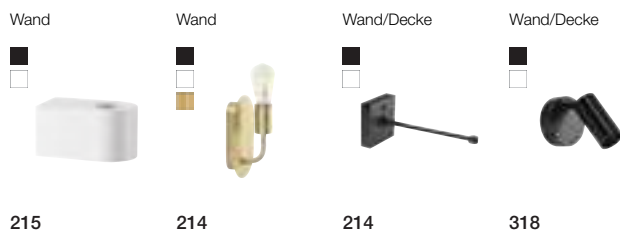
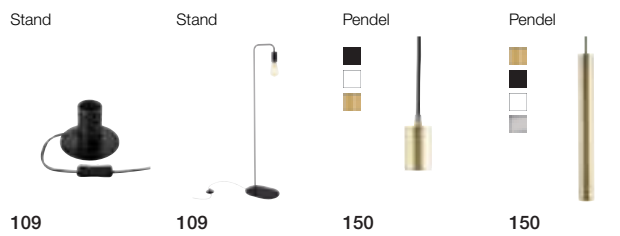



FORCHINI



GLENOS

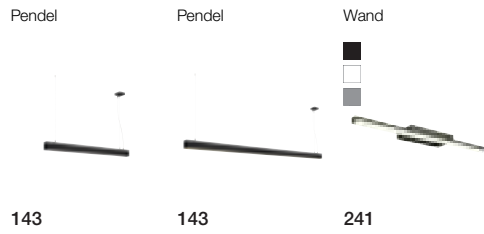

GLOO PURE

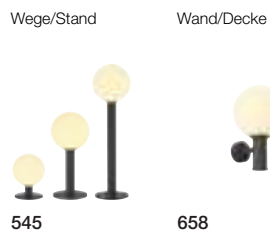

GRAFIT















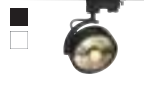

HELIA

<p>Pendel</p>  <p>158</p>	<p>Pendel</p>  <p>159</p>	<p>Pendel</p>  <p>158</p>	<p>Pendel</p>  <p>159</p>	<p>Pendel</p>  <p>157</p>	<p>Pendel</p>  <p>157</p>
<p>Wand/Decke</p>  <p>299</p>	<p>Wand/Decke</p>  <p>299</p>	<p>Einbau</p>  <p>400</p>	<p>3Ph.-Stromschiene</p>  <p>457</p>	<p>1Ph.-Stromschiene</p>  <p>483</p>	
<p>Wege/Stand</p>  <p>581</p>	<p>Wege/Stand</p>  <p>581</p>	<p>Wege/Stand</p>  <p>828</p>	<p>Wege/Stand</p>  <p>582</p>		
<p>Strahler</p>  <p>599</p>	<p>Strahler</p>  <p>599</p>	<p>Wand</p>  <p>685</p>	<p>Wand</p>  <p>685</p>		

KALU

<p>Wand/Decke</p>  <p>302</p>	<p>Wand/Decke</p>  <p>302</p>	<p>Wand/Decke</p>  <p>302</p>	<p>Wand/Decke</p>  <p>302</p>		
<p>Wand/Decke</p>  <p>304</p>	<p>Wand/Decke</p>  <p>304</p>	<p>Wand/Decke</p>  <p>304</p>	<p>Wand/Decke</p>  <p>304</p>		
<p>3Ph.-Stromschiene</p>  <p>454</p>	<p>3Ph.-Stromschiene</p>  <p>454</p>	<p>3Ph.-Stromschiene</p>  <p>454</p>	<p>1Ph.-Stromschiene</p>  <p>484</p>	<p>1Ph.-Stromschiene</p>  <p>484</p>	<p>1Ph.-Stromschiene</p>  <p>484</p>



KARPO

Tisch 108	Stand 108	Wand 224	Wand 224	Wand 225	Wand 225	
Wand/Decke 296	Wand/Decke 296	Einbau 400				

LIGHT EYE

Pendel 172	Pendel 172	3Ph.-Stromschiene 446	3Ph.-Stromschiene 446	1Ph.-Stromschiene 476	1Ph.-Stromschiene 476
Easytec® II 495	Easytec® II 495				

LISENNE

Pendel 164	Wand 213	Wege/Stand 553	Wege/Stand 553		
-------------------	-----------------	-----------------------	-----------------------	--	--

L-LINE

Wand 242	Wand 242	Wege/Stand 538	Wege/Stand 538	Wege/Stand 538, 539	Wand 656
-----------------	-----------------	-----------------------	-----------------------	----------------------------	-----------------

LOGS

Wand 196	Wand 196	Wand 197	Wand 197	Wege/Stand 517	Wege/Stand 517	Wand 652
-----------------	-----------------	-----------------	-----------------	-----------------------	-----------------------	-----------------



MAGANDA

Tisch



113

Wand



232

MANA

Wand



185

Wand



185

Wand



185

Wand



185

Wand



186

Schirm



186

Schirm



186

Wand



187

Wand



187

Schirm



187

Schirm



187

Wand



655

MECANICA

Tisch



111

Stand



111

MEDO LED

Pendel/Decke



133, 257

Pendel/Decke



132, 257

Pendel/Decke



130, 254

Pendel/Decke



131, 255

Pendel/Decke



131, 255

Pendel/Decke



131, 255

Pendel/Decke



134, 258

Pendel/Decke



134, 258

Pendel/Decke



134, 258

Pendel/Decke



135, 259

Pendel/Decke



136, 260

Pendel/Decke



136, 260

Pendel/Decke



136, 260

Pendel/Decke



137, 261

Pendel/Decke



132, 256

Pendel/Decke



138, 261

Pendel



128

Pendel

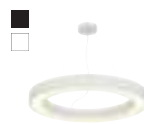

128

Pendel

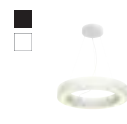

129

Einbau



414, 415

Einbau



416, 417



MOLAT



MYRA



NAUTILUS

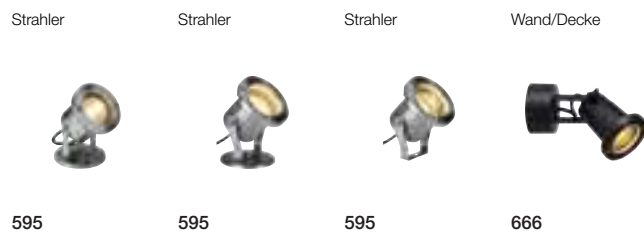

NOBLO

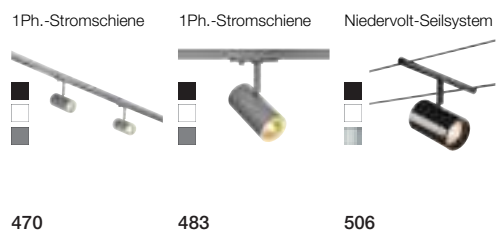
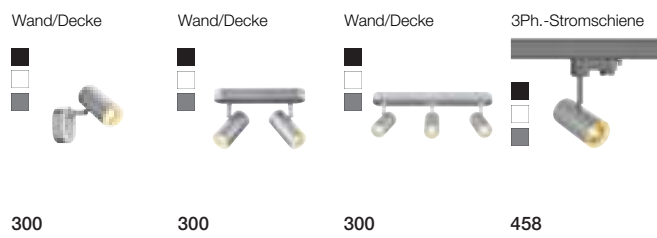



NUMINOS®

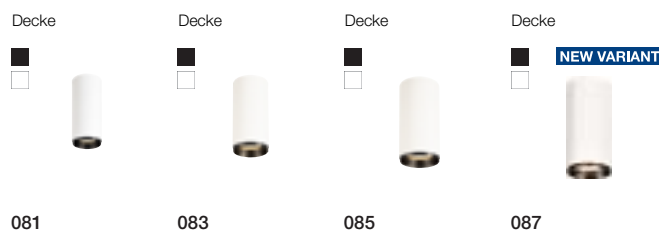
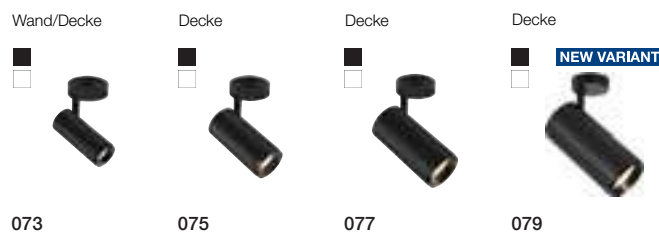
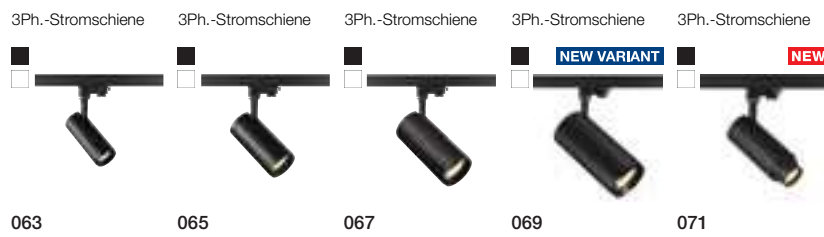
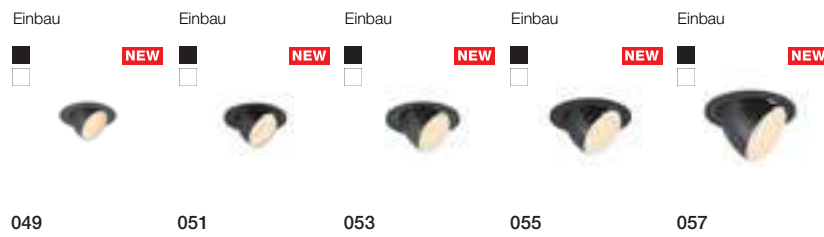
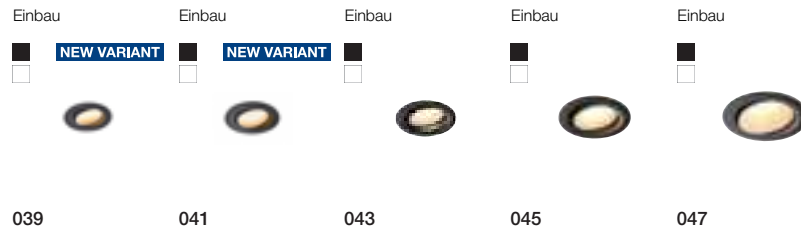
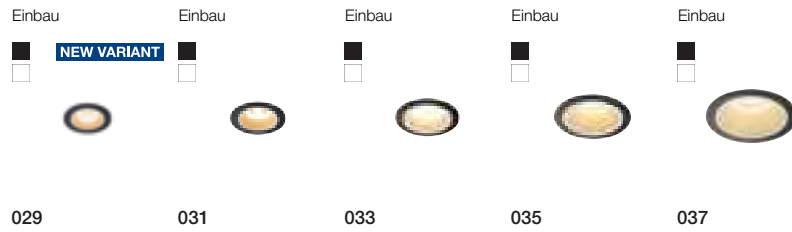

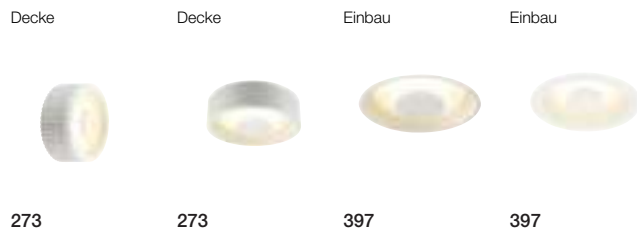
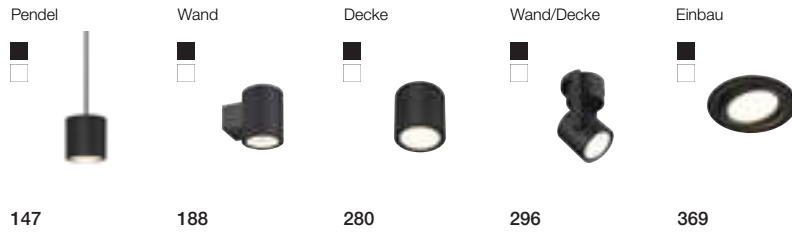
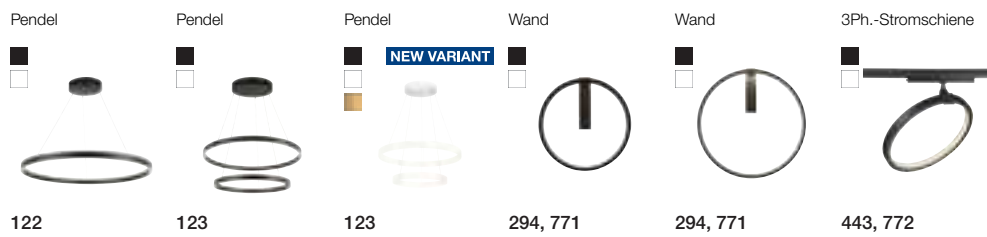
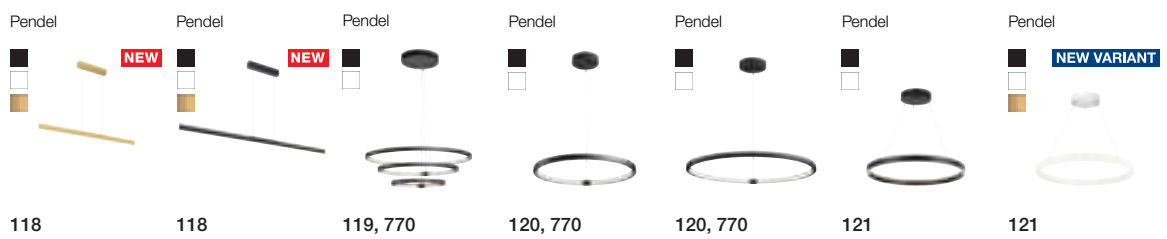
**OCCULDAS**Design:
David Morgan**OCULUS****ONE****OVALISK****PARA CONE**



PLASTRA

Pendel 	Wand 	Wand 	Wand 	Wand 	Wand 	Wand 
175	190	190	191	191	193	193
Wand 	Wand 	Wand 	Wand 	Wand 	Decke 	Decke 
193	194	194	194	223	282	282
Decke 	Decke 	Einbau 	Einbau 			
282	283	402	403			







P-LIGHT

Wand/Decke 	Wand/Decke 	Wand/Decke 	Einbau 
340	340	341	420

PURI

Wand/Decke 	Wand/Decke 	Wand/Decke 	Wand/Decke 	3Ph.-Stromschiene 	3Ph.-Stromschiene 
312	312	312	312	453	453
1Ph.-Stromschiene 	1Ph.-Stromschiene 	1Ph.-Stromschiene 			
470	478	478			

Q-LINE

Pendel 	Pendel 	Pendel 	Wand 	Decke 	Decke 
144, 145	144, 145	145, 775	243	264	265



QUADRASS



QUADRASYL



QUADRULO



RASCALI

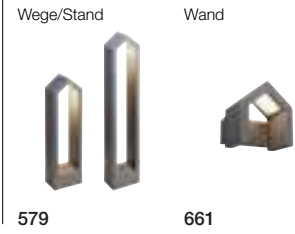

ROTOBALL

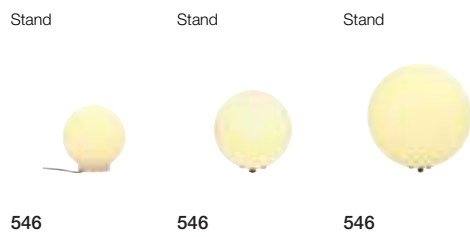

ROX



RUSTY





SENSER

Wand/Decke	Wand/Decke	Wand/Decke	Wand/Decke	Wand/Decke	Wand/Decke
319	319	319	320	320	320
Einbau	Einbau	Einbau	Einbau	Einbau	Einbau
389	389	389	390	390	390

SIGHT LED

Wand/Decke	Wand/Decke	3Ph.-Stromschiene	3Ph.-Stromschiene	3Ph.-Stromschiene	3Ph.-Stromschiene
337	337	440	441, 773	448	450

SITRA

Wege/Stand	Spieß	Spieß	Wand	Wand	Wand	Wand
583	602	603	622	622	624	624
Wand	Wand	Wand	Wand	Decke	Wand/Decke	
624	644	644	661	679	684	

SLOTS

Wege/Stand	Wege/Stand	Wand
570	571	647

SQUARE

Wege/Stand	Wege/Stand	Wege/Stand	Wand	Wand
568	568	568	660	662



SUPROS

Pendel 	Pendel 	Wand 	Decke 	Decke
148	148, 149	189	270	271
Einbau 	Einbau 	Einbau 	Einbau 	
382	383	384, 385	386, 387	

THEO

Wand 	Wege/Stand 	Wege/Stand 	Wege/Stand 	Spieß 			
216	540	540	541	601			
Wand 	Wand 	Wand 	Wand 	Wand 	Wand 	Wand 	
618	619	619	619	620	621	621	
Decke 	Decke 	Decke 					
674	674	684					

TONGA

Pendel 	1Ph.-Stromschiene 	Easytec® II
165	475	494

WORKLIGHT

Tisch 	Stand 	Pendel
100	101	146, 774



1005394 100

1005392 100



NUMINOS®

DOWN- UND SPOTLIGHTS

finden Sie auf den folgenden Seiten:

Einbauleuchten	28 - 57
3-Phasen Stromschienen	62 - 71
Wand- und Deckenleuchten	72 - 73
Deckenleuchten	72 - 86
Pendelleuchten	88 - 95

Oder ganz einfach online konfigurieren unter: www.numinos.slv.com





Hinweis: 7-stellige Art. Nr. finden Sie ab Seite 843

111000		113540..... 355	114386..... 360
111262..... 409	113541..... 355	114390..... 361	
111292..... 408	113550..... 355	114391..... 361	
111360..... 352	113830..... 355	114396..... 361	
111361..... 353	113840..... 355	114400..... 356	
111362..... 354	113841..... 355	114401..... 356	
111380..... 355	113870..... 362	114406..... 356	
111381..... 355	113871..... 362	114420..... 421, 707	
111382..... 355	113876..... 362	114421..... 421, 707	
111710..... 352	113880..... 362	114426..... 421, 707	
111711..... 352	113881..... 362	114430..... 421, 707	
111716..... 352	113886..... 362	114431..... 421, 707	
111720..... 352	113890..... 364	114436..... 421, 707	
111721..... 352	113891..... 364	114440..... 422, 708	
111726..... 352	113896..... 364	114441..... 422, 708	
111850..... 804	113900..... 362	114450..... 422, 708	
111861..... 804	113901..... 362	114451..... 422, 708	
	113906..... 362	114460..... 423, 708	
112000	113910..... 363	114461..... 423, 708	
112161..... 394	113911..... 363	114480..... 399	
112162..... 394	113916..... 363	114481..... 399	
112165..... 394	113920..... 365	114490..... 399	
112221..... 394	113921..... 365	114491..... 399	
112222..... 394	113926..... 365		
112225..... 394	113930..... 269	115000	
112242..... 404	113931..... 269	115510..... 376	
112682..... 393	113940..... 269	115511..... 376	
112692..... 393	113941..... 269	115520..... 376	
112702..... 393	113951..... 357	115521..... 376	
112720..... 408	113956..... 357	115530..... 376	
112721..... 408	113961..... 357	115531..... 376	
112780..... 408, 409, 410	113966..... 357	115540..... 378	
112781..... 408, 409, 410	113970..... 356	115541..... 378	
112910..... 372	113971..... 356	115550..... 378	
112911..... 372	113976..... 356	115551..... 378	
		115700..... 379	
113000	114000	115701..... 379	
113140..... 370	114102..... 148, 149, 270,	115710..... 379	
113141..... 370 384, 385, 386, 387	115711..... 379	
113150..... 371	114104..... 148, 149, 270,	115720..... 379	
113151..... 371 384, 385, 386, 387	115721..... 379	
113160..... 372	114220..... 366	115730..... 380	
113161..... 372	114221..... 366	115731..... 380	
113170..... 374	114230..... 366	115740..... 380	
113171..... 374	114231..... 366	115741..... 380	
113262..... 409	114240..... 366		
113292..... 408	114241..... 366	116000	
113440..... 351	114250..... 367	116302..... 148, 189, 271, 382, 383	
113441..... 351	114251..... 367	116304..... 148, 189, 271, 382, 383	
113446..... 351	114260..... 368	116310..... 382	
113450..... 351	114261..... 368	116311..... 382	
113451..... 351	114270..... 368	116320..... 383	
113456..... 351	114271..... 368	116321..... 383	
113490..... 352	114280..... 369	116330..... 271	
113491..... 353	114281..... 369	116331..... 271	
113492..... 354	114290..... 369	116340..... 189	
113510..... 352	114291..... 369	116341..... 189	
113511..... 353	114380..... 360		
113512..... 354	114381..... 360		

117000	135124.....	131, 255	143042.....	467
117100.....	135170.....	131, 255	143050.....	467
117101.....	135171.....	131, 255	143051.....	467
117110.....	135174.....	131, 255	143052.....	467
117111.....	135250.....	135, 255, 295, 785	143060.....	467
117311.....	135251.....	135, 255, 295, 785	143061.....	467
117321.....	135254.....	135, 255, 295, 785	143062.....	467
117331.....			143070.....	467
117351.....			143071.....	467
	138000		143072.....	467
	138981.....	501, 793	143080.....	467
132000	138982.....	501, 793	143081.....	467
132020.....	138991.....	501, 793	143082.....	467
132021.....	138992.....	501, 793	143090.....	467
132024.....			143091.....	467
132600.....	139000		143092.....	467
132601.....	139004.....	500	143100.....	467
132605.....	139006.....	500	143101.....	467
132610.....	139024.....	500	143102.....	467
132611.....	139026.....	500	143110.....	467
132615.....	139030.....	500	143111.....	467
132620.....	139031.....	500	143112.....	467
132621.....	139040.....	500	143120.....	151, 467, 469, 473
132625.....	139041.....	500	143121.....	151, 467, 469, 473
132660.....	139050.....	500	143124.....	151, 467, 469, 473
132661.....	139051.....	500	143130.....	467
132662.....	139060.....	500	143131.....	467
132670.....	139061.....	500	143132.....	467
132671.....	139070.....	502	143151.....	467
132680.....	139071.....	502	143152.....	467
132681.....	139072.....	502	143160.....	467
132690.....	139080.....	502	143161.....	467
132691.....	139081.....	502	143162.....	467
132835.....	139082.....	502	143169.....	467
	139090.....	503	143170.....	467, 469
133000	139091.....	503	143171.....	467, 469
133019.....	139092.....	503	143172.....	467, 469
133060.....	139100.....	503	143190.....	470
133120.....	139101.....	503	143191.....	470
133121.....	139102.....	503	143194.....	470
133310.....	139110.....	504	143221.....	469
133320.....	139111.....	504	143230.....	469
133444.....	139112.....	504	143231.....	469
133481.....	139120.....	506	143241.....	469
133482.....	139121.....	506	143251.....	469
133489.....	139122.....	506	143261.....	469
133490.....	139130.....	503	143281.....	469
133491.....	139131.....	503	143350.....	485
133840.....	139132.....	503	143351.....	485
133841.....			143354.....	485
133850.....	143000		143380.....	467
133851.....	143010.....	465	143381.....	467
	143011.....	465	143382.....	467
135000	143012.....	465	143390.....	478
135020.....	143020.....	465	143391.....	478
135021.....	143021.....	465	143392.....	478
135024.....	143022.....	465	143430.....	482
135070.....	143030.....	467	143431.....	482
135071.....	143031.....	467	143432.....	482
135074.....	143032.....	467	143440.....	482
135120.....	143040.....	467	143441.....	482
135121.....	143041.....	467		

143442.....	482	145670.....	437	148018.....	190
143450.....	478	145674.....	437	148019.....	223
143451.....	478	145680.....	437	148060.....	193
143454.....	478	145684.....	437	148070.....	402
143540.....	484	145690.....	437	148071.....	403
143541.....	484	145694.....	437	148091.....	193
143544.....	484	145700.....	437	148540.....	230
143580.....	483	145710.....	437		
143581.....	483	145714.....	437	149000	
143594.....	475	145720.....	437	149381.....	161
143620.....	476	145724.....	437	149387.....	161
143621.....	476	145730.....	437	149388.....	161
143731.....	484	145734.....	437	149452.....	222
143811.....	485	145830.....	437	149471.....	205
143930.....	477	145834.....	437	149511.....	205
143932.....	477	145990.....	151, 437, 473	149762.....	234
143941.....	480	145994.....	151, 437, 473	149772.....	234
143951.....	480				
143960.....	481	146000		151000	
143961.....	481	146000.....	110	151040.....	172, 228, 476
143964.....	481	146010.....	110	151041.....	172, 245, 476
143990.....	474	146332.....	245	151049.....	172, 245, 476
143991.....	474	146472.....	245	151271.....	201
		146682.....	229	151275.....	201
144000		146692.....	228	151282.....	237
144010.....	476			151311.....	200
144011.....	476	147000		151315.....	200
144019.....	476	147301.....	304	151320.....	196
144200.....	479	147306.....	304	151321.....	196
144201.....	479	147311.....	304	151325.....	196
144204.....	479	147316.....	304	151410.....	202
		147321.....	304	151411.....	202
145000		147326.....	304	151416.....	202
145100.....	435	147360.....	312	151450.....	202
145102.....	435	147361.....	312	151451.....	202
145200.....	435	147370.....	312	151456.....	202
145202.....	435	147371.....	312	151511.....	274
145300.....	435	147380.....	312	151514.....	274
145302.....	435	147381.....	312	151531.....	274, 308
145510.....	437	147411.....	311	151534.....	274, 308
145514.....	437	147412.....	311	151591.....	211
145520.....	437	147414.....	311	151710.....	203
145524.....	437	147441.....	316	151711.....	203
145530.....	437	147442.....	316	151740.....	203
145534.....	437	147443.....	316	151741.....	203
145551.....	439	147444.....	316	151781.....	207
145560.....	437	147529.....	211	151786.....	207
145564.....	437	147550.....	308	151791.....	207
145580.....	437	147551.....	308	151796.....	207
145584.....	437	147559.....	308	151800.....	217
145590.....	437			151801.....	217
145594.....	437	148000		151803.....	217
145600.....	437	148001.....	282	151804.....	217
145604.....	437	148002.....	283	151810.....	281
145630.....	437	148004.....	282	151811.....	281
145634.....	437	148005.....	282	151813.....	281
145640.....	437	148010.....	191	151830.....	307
145644.....	437	148012.....	194	151831.....	307
145660.....	437	148013.....	194	151840.....	217, 281, 307
145664.....	437	148016.....	194	151850.....	161

151851.....	161	153850.....	452	165390.....	174
151853.....	161	153851.....	452	165400.....	174
151950.....	412			165410.....	174
151952.....	412	155000			
151960.....	412	155156.....	288	175000	
151962.....	412	155180.....	332	175060.....	433
		155236.....	332	175080.....	433
152000		155373.....	278	175160.....	433
152010.....	307	155490.....	105	175180.....	433
152011.....	307	155492.....	105	175190.....	433
152013.....	307	155530.....	170	175210.....	433
152020.....	307	155540.....	105		
152021.....	307	155550.....	276	181000	
152023.....	307	155551.....	276	181530.....	501
152101.....	281	155552.....	276	181531.....	501
152230.....	456	155582.....	107, 155, 277	181532.....	501
152231.....	456	155583.....	107, 155, 277		
152232.....	456	155592.....	107, 155, 277	184000	
152240.....	456	155714.....	164	184000.....	491
152241.....	456	155752.....	213	184002.....	491
152242.....	456	155780.....	104	184004.....	491
152320.....	453	155785.....	104	184010.....	491
152321.....	453	155790.....	104	184012.....	491
152330.....	296	155795.....	104	184020.....	491
152331.....	296	155870.....	156	184022.....	491
152340.....	225	155871.....	156	184030.....	491
152341.....	225	155910.....	171	184032.....	491
152360.....	158	155930.....	171	184060.....	491
152361.....	158			184062.....	491
152370.....	159	156000		184071.....	492
152371.....	159	156050.....	278	184140.....	491
152380.....	400	156051.....	278	184142.....	491
152381.....	400	156100.....	155, 277	184170.....	491
152430.....	459	156111.....	107, 155, 277	184172.....	491
152431.....	459	156113.....	107, 155, 277	184290.....	491
152600.....	454	156122.....	107, 155, 277	184292.....	491
152601.....	454	156141.....	107, 155	184300.....	491
152610.....	454	156143.....	107, 155	184302.....	491
152611.....	454	156152.....	107, 155	184330.....	491
152640.....	459	156500.....	299	184332.....	491
152641.....	459	156501.....	299	184440.....	492
152750.....	451	156510.....	299	184450.....	492
152751.....	451	156511.....	299	184452.....	492
152780.....	451	156530.....	400	184530.....	494
152781.....	451	156531.....	400	184534.....	494
152960.....	457			184590.....	495
152961.....	457	158000		184630.....	494
		158400.....	158	184634.....	494
153000		158401.....	158		
153112.....	446	158410.....	159	185000	
153130.....	447	158411.....	159	185580.....	495
153140.....	445			185590.....	495
153141.....	445	161000			
153420.....	452	161271.....	398	186000	
153421.....	452	161291.....	398	186300.....	501
153560.....	453	161461.....	285	186301.....	501
153561.....	453			186302.....	501
153564.....	453	165000		186310.....	501
153580.....	454	165358.....	179	186311.....	501
153581.....	454	165359.....	179	186312.....	501

186330.....	501	228730.....	805	229702.....	703
186331.....	501	228752.....	582, 583	229740.....	594
186332.....	501	228753.....	550, 570, 571	229741.....	595
186340.....	501	228754.....	517, 521	229931.....	692
186341.....	501	228771.....	641	229935.....	692
186342.....	501	228775.....	641	229961.....	688
186350.....	501	228776.....	641	229965.....	688
186351.....	501	228925.....	557	229971.....	688
186352.....	501	228935.....	557	229975.....	688
186360.....	501	228945.....	557		
186361.....	501	228965.....	555	230000	
186362.....	501			230030.....	639
186640.....	501	229000		230034.....	639
186641.....	501	229020.....	533	230060.....	516, 552, 565, 583
186642.....	501	229021.....	533	230061.....	565
		229022.....	532, 533	230063.....	565
210000		229050.....	562	230066.....	565
210060.....	803	229054.....	562	230069.....	565
210061.....	803	229057.....	562	230084.....	630
210064.....	803	229059.....	562	230085.....	630
		229062.....	703	230090.....	527
220000		229071.....	691	230355.....	661
220000.....	804	229072.....	691	230365.....	644
		229075.....	691	230435.....	551
227000		229081.....	691	230465.....	550
227140.....	792	229085.....	691	230655.....	630
227160.....	792	229090.....	595	230657.....	630
227176.....	661	229110.....	702		
227194.....	647	229162.....	560	231000	
227195.....	647	229172.....	560	231010.....	638
227219.....	546	229182.....	660	231012.....	638
227220.....	546	229200.....	722	231015.....	638
227221.....	546	229230.....	722	231035.....	597
227410.....	593	229234.....	722	231072.....	591
227418.....	593	229320.....	721	231205.....	627
227462.....	724	229324.....	721	231215.....	521
227504.....	601	229374.....	721	231225.....	521
227505.....	601	229381.....	718	231230.....	517, 521, 524, 525
227507.....	601	229383.....	718	231231.....	577
227600.....	730	229410.....	524	231233.....	535
227604.....	730	229411.....	525	231234.....	545, 561, 568
227680.....	731	229420.....	529	231235.....	536, 537
227684.....	731	229421.....	529	231305.....	577
227922.....	559, 560	229422.....	527, 528, 529, 534, 553, 530	231315.....	662
		229430.....	530	231351.....	642
228000		229431.....	530	231355.....	642
228100.....	559	229432.....	530	231370.....	536
228110.....	559	229524.....	620	231371.....	536
228130.....	559	229525.....	620	231410.....	534
228332.....	724	229531.....	618	231411.....	534
228342.....	724	229532.....	618	231420.....	535
228370.....	722	229535.....	618	231440.....	537
228412.....	716	229551.....	674	231455.....	571
228430.....	721	229554.....	674	231457.....	571
228434.....	721	229555.....	674	231465.....	659
228545.....	580	229564.....	621	231475.....	566
228555.....	599	229565.....	621	231505.....	583
228712.....	542, 557, 582, 583	229574.....	619	231515.....	684
228722.....	542, 557	229575.....	619	231525.....	602
228725.....	805	229664.....	655	231535.....	603
228726.....	561, 577, 805	229665.....	655	231541.....	679

231545.....	679	233165.....	582, 583	464140.....	412, 798
231585.....	659	233184.....	583	464141.....	157, 375
231595.....	567	233185.....	583	464142.....	798
231805.....	647	233215.....	644, 665, 666	464144.....	798
231807.....	647	233245.....	685	464147.....	349
231815.....	570	233255.....	685	464200.....	801
231817.....	570	233275.....	582	464804.....	799
		233285.....	582		
232000		233302.....	641	470000	
232045.....	657	233407.....	532	470500.....	796
232055.....	677	233417.....	532	470505.....	792
232065.....	548	233427.....	528	470548.....	796
232075.....	549	233437.....	528	470549.....	796
232085.....	549	233447.....	524		
232095.....	548	233457.....	524	560000	
232101.....	652	233500.....	718	560231.....	811
232104.....	652	233540.....	723	560232.....	811
232105.....	652	233570.....	598	560233.....	811
232115.....	517	233571.....	598	560234.....	811
232119.....	517	233580.....	598		
232125.....	517	233582.....	598	631000	
232135.....	574	233601.....	701	631337.....	339
232145.....	574	233605.....	701	631339.....	339
232155.....	572	233611.....	701	631347.....	339
232165.....	572	233615.....	701	631349.....	339
232175.....	573	233621.....	701	900011.....	595, 598
232185.....	573	233625.....	701		
232195.....	572, 573	233635.....	700	955000	
232285.....	662	233639.....	700	955135.....	804
232294.....	577	233650.....	702		
232295.....	577	233660.....	702	961000	
232431.....	622	233792.....	724	961034.....	804
232435.....	633			961037.....	803
232441.....	634	234000		961250.....	803
232445.....	634	234505.....	619	961270.....	803
232461.....	633	234515.....	619	961271.....	803
232465.....	633	234525.....	621	961276.....	803
232471.....	634	234535.....	674		
232475.....	634			1000100	
232485.....	652	240000		1000127.....	303
232491.....	652	240000.....	340	1000128.....	303
232495.....	652	240002.....	340	1000129.....	303
232497.....	652	240004.....	341	1000130.....	303
232531.....	622	240006.....	420	1000131.....	303
232535.....	622	240007.....	340, 341	1000132.....	303
232537.....	622	240008.....	340, 341	1000135.....	303
232905.....	651	240009.....	341	1000136.....	303
232915.....	651	240010.....	341		
		240020.....	340	1000300	
233000		240021.....	340	1000327.....	216
233094.....	686	240022.....	341	1000329.....	216
233095.....	686	240024.....	420	1000330.....	216
233104.....	666			1000331.....	618
233105.....	666	461000		1000332.....	679
233114.....	644	461060.....	792	1000333.....	645
233115.....	644	461157.....	792	1000334.....	645
233134.....	665			1000335.....	662
233135.....	665	464000		1000336.....	660
233144.....	583	464031.....	801	1000339.....	679
233145.....	582, 583	464107.....	801	1000340.....	647
233164.....	583	464108.....	800	1000342.....	647

1000343.....	568	1000533.....	741	1000683.....	558
1000344.....	568	1000534.....	741	1000685.....	264
1000345.....	568	1000535.....	745	1000686.....	264
1000346.....	568	1000536.....	745	1000688.....	264
1000384.....	724	1000537.....	745	1000689.....	264
1000398.....	548, 552	1000540.....	743	1000691.....	265
		1000546.....	743	1000692.....	265
1000400		1000549.....	743	1000694.....	265
1000422.....	199	1000552.....	743	1000695.....	265
1000423.....	199	1000555.....	743		
1000426.....	298	1000556.....	744	1000700	
1000427.....	298	1000557.....	744	1000702.....	304
1000443.....	288	1000558.....	744	1000703.....	304
1000445.....	288	1000559.....	744	1000704.....	304
1000457.....	735	1000560.....	744	1000707.....	446
1000458.....	735	1000561.....	744	1000708.....	446
1000459.....	735	1000562.....	744	1000709.....	446
1000460.....	735	1000563.....	744	1000711.....	480
1000461.....	735	1000564.....	744	1000712.....	480
1000462.....	735	1000565.....	744	1000713.....	476
1000463.....	735	1000566.....	744	1000714.....	395
1000464.....	735	1000567.....	744	1000715.....	395
1000465.....	735	1000568.....	744	1000716.....	395
1000466.....	736, 739	1000569.....	744	1000717.....	395
1000467.....	736, 739	1000570.....	744	1000718.....	395
1000468.....	736, 739	1000571.....	743	1000719.....	395
1000469.....	736, 739	1000574.....	408	1000720.....	395
1000470.....	736	1000575.....	408	1000721.....	395
1000471.....	736	1000576.....	409	1000725.....	132, 256
1000472.....	737	1000577.....	409	1000726.....	132, 256
1000473.....	737	1000579.....	107, 155, 277	1000727.....	132, 256
1000474.....	737	1000580.....	107, 155, 277	1000729.....	217
1000475.....	737			1000730.....	217
1000476.....	737	1000600		1000731.....	217
1000477.....	737	1000613.....	186	1000735.....	599
1000478.....	737	1000614.....	187	1000736.....	581, 599
1000479.....	737	1000615.....	187	1000746.....	333
1000480.....	737	1000616.....	186	1000748.....	333
1000481.....	737	1000618.....	186	1000763.....	106
1000482.....	737	1000619.....	186	1000764.....	107, 154
1000483.....	737	1000621.....	187	1000773.....	154
1000484.....	737	1000623.....	187	1000777.....	238
1000485.....	737	1000624.....	187	1000780.....	239
1000486.....	737	1000631.....	281	1000783.....	262
1000487.....	736	1000634.....	201	1000784.....	262
1000489.....	736	1000635.....	201	1000785.....	262
1000496.....	742	1000636.....	201	1000786.....	262
1000497.....	742	1000637.....	201	1000797.....	661
1000498.....	742	1000638.....	196	1000799.....	579
		1000639.....	196		
1000500		1000640.....	196	1000800	
1000505.....	741	1000655.....	724	1000801.....	579
1000506.....	741	1000656.....	457	1000807.....	287
1000507.....	741	1000657.....	457	1000808.....	287
1000514.....	741	1000665.....	553	1000809.....	164, 287
1000515.....	741	1000666.....	553	1000810.....	164, 287
1000516.....	741	1000668.....	243	1000811.....	164, 287
1000523.....	741	1000669.....	243	1000812.....	164, 287
1000524.....	741	1000670.....	243	1000813.....	164
1000525.....	741	1000681.....	658	1000820.....	657
1000532.....	741	1000682.....	558	1000821.....	552

1000822.....	552	1001200		1001468.....	231
1000823.....	677	1001250.....	418, 784	1001472.....	231
1000824.....	186	1001251.....	418, 784	1001488.....	561
1000825.....	187	1001252.....	728	1001489.....	561
1000827.....	179	1001253.....	728	1001490.....	561
1000833.....	407, 709	1001254.....	728	1001494.....	561
1000855.....	130, 254	1001255.....	728	1001495.....	296
1000856.....	130, 254	1001256.....	728	1001496.....	296
1000857.....	130, 254	1001262.....	728		
1000864.....	131, 255	1001263.....	728	1001500	
1000865.....	131, 255	1001264.....	407	1001505.....	262
1000866.....	131, 255	1001267.....	799	1001506.....	262
1000880.....	665	1001272.....	218	1001508.....	262
1000881.....	665	1001273.....	218	1001509.....	262
1000886.....	315	1001274.....	218	1001510.....	435
1000887.....	315	1001275.....	218	1001511.....	435
1000889.....	315	1001276.....	218	1001512.....	435
1000890.....	315	1001283.....	337	1001513.....	437
1000892.....	315	1001284.....	337	1001514.....	437
1000893.....	315	1001285.....	337	1001515.....	437
1000895.....	315	1001286.....	337	1001516.....	437
1000896.....	315	1001287.....	337	1001517.....	437
		1001288.....	337	1001518.....	437
1000900		1001299.....	242	1001519.....	437
1000909.....	804			1001520.....	437
1000910.....	216	1001300		1001521.....	437
1000911.....	216	1001300.....	242	1001522.....	437
1000914.....	370	1001301.....	242	1001523.....	437
1000915.....	370	1001303.....	242	1001524.....	437
1000917.....	370	1001304.....	242	1001525.....	437
1000918.....	179	1001305.....	242	1001526.....	437
1000926.....	144	1001309.....	145, 775	1001527.....	437
1000927.....	144	1001310.....	145, 775	1001528.....	437
1000929.....	144	1001314.....	692	1001529.....	437
1000930.....	144	1001315.....	692	1001530.....	437
1000932.....	145	1001317.....	692	1001531.....	439
1000933.....	145	1001359.....	728	1001532.....	439
1000935.....	145	1001380.....	433	1001533.....	439
1000936.....	145	1001382.....	433	1001534.....	439
1000957.....	155, 277	1001390.....	433	1001536.....	439
		1001392.....	433	1001537.....	439
1001000		1001395.....	433	1001538.....	439
1001015.....	406, 710			1001539.....	439
1001016.....	406, 710	1001400		1001542.....	151, 437, 439, 473
1001017.....	406, 710	1001400.....	143	1001574.....	811
1001018.....	406, 710	1001403.....	143	1001575.....	811
1001019.....	336	1001406.....	143		
1001020.....	336	1001409.....	143	1001600	
		1001419.....	459	1001676.....	109
1001100		1001420.....	459	1001691.....	179
1001155.....	401	1001449.....	219	1001692.....	179
1001156.....	401	1001450.....	219		
1001165.....	405, 713	1001451.....	218	1001700	
1001166.....	405, 713	1001452.....	218	1001701.....	170
1001167.....	405, 713	1001453.....	218		
1001168.....	405, 713	1001454.....	218	1001800	
1001169.....	405, 713	1001460.....	108	1001818.....	151, 473
1001170.....	405, 713	1001461.....	108	1001819.....	151, 473
1001171.....	405, 713	1001462.....	108	1001820.....	151
1001172.....	405, 713	1001463.....	108	1001821.....	151

1001823.....	527	1001968.....	474	1002102.....	420, 706
1001824.....	527	1001969.....	642	1002103.....	420, 706
1001855.....	690	1001970.....	642	1002110.....	480
1001856.....	690	1001978.....	361	1002111.....	480
1001861.....	485	1001980.....	350	1002113.....	480
1001862.....	483	1001981.....	350	1002116.....	229
1001863.....	483	1001982.....	350	1002117.....	228
1001864.....	483	1001989.....	361	1002118.....	228
1001865.....	458	1001990.....	361	1002119.....	228
1001866.....	458	1001991.....	361	1002140.....	225
1001868.....	478	1001992.....	361	1002146.....	109
1001869.....	478	1001993.....	361	1002147.....	214
1001870.....	478	1001994.....	350	1002148.....	214
1001871.....	453	1001995.....	350	1002149.....	214
1001872.....	453	1001996.....	350	1002151.....	465
1001877.....	134, 258	1001999.....	545	1002152.....	465
1001878.....	135, 259			1002153.....	465
1001879.....	135, 259	1002000		1002163.....	151
1001880.....	135, 259	1002000.....	545	1002164.....	151
1001881.....	134, 258	1002001.....	545	1002165.....	151
1001882.....	134, 258	1002002.....	658	1002168.....	150
1001883.....	134, 258	1002003.....	269	1002169.....	159
1001884.....	134, 258	1002004.....	266	1002170.....	158
1001885.....	134, 258	1002005.....	266	1002171.....	159
1001886.....	134, 258	1002006.....	266	1002172.....	158
1001887.....	134, 258	1002008.....	269	1002188.....	716
1001888.....	134, 258	1002010.....	266	1002190.....	235
1001889.....	136, 260	1002011.....	266	1002191.....	235
1001890.....	137, 261	1002012.....	266	1002192.....	235
1001891.....	137, 261	1002013.....	266	1002198.....	581
1001892.....	137, 261	1002015.....	266		
1001893.....	136, 260	1002018.....	644	1002200	
1001894.....	136, 260	1002020.....	326	1002200.....	581
1001895.....	136, 260	1002021.....	326	1002201.....	601
1001896.....	136, 260	1002022.....	326	1002203.....	601
1001897.....	136, 260	1002023.....	304	1002215.....	274, 308
1001898.....	136, 260	1002024.....	304	1002216.....	274
1001899.....	136, 260	1002025.....	304	1002217.....	154
		1002029.....	312	1002218.....	777, 794
1001900		1002030.....	312	1002220.....	777, 794
1001900.....	136, 260	1002032.....	622	1002221.....	777, 794
1001901.....	414	1002033.....	622	1002228.....	237
1001902.....	415	1002034.....	622	1002229.....	237
1001903.....	415	1002035.....	686	1002238.....	191
1001904.....	415	1002045.....	173	1002239.....	208
1001905.....	416	1002046.....	173	1002240.....	208
1001906.....	416	1002047.....	175	1002264.....	151
1001907.....	416	1002051.....	289	1002265.....	151
1001908.....	417	1002052.....	289		
1001930.....	404, 711	1002069.....	639	1002400	
1001931.....	404, 711	1002070.....	639	1002402.....	629
1001937.....	597	1002075.....	329	1002403.....	629
1001939.....	285	1002076.....	329	1002404.....	111
1001950.....	135, 255, 295, 785	1002077.....	329	1002405.....	111
1001951.....	135, 255, 295, 785	1002098.....	420, 706	1002411.....	782
1001952.....	135, 255, 295, 785	1002099.....	420, 706	1002420.....	801
1001962.....	595			1002422.....	802
1001963.....	595	1002100		1002423.....	800
1001964.....	593	1002100.....	420, 706	1002424.....	800
1001965.....	593	1002101.....	420, 706	1002425.....	800

1002430.....	228	1002659.....	433	1002891.....	129
1002431.....	228	1002660.....	433	1002893.....	719
1002432.....	228	1002686.....	445	1002895.....	719
1002494.....	554	1002688.....	506	1002897.....	719
		1002689.....	506	1002898.....	719
1002500		1002690.....	506	1002899.....	719
1002503.....	643	1002691.....	793		
1002504.....	643	1002692.....	793	1002900	
1002505.....	643	1002693.....	793	1002900.....	655
1002558.....	150	1002694.....	506	1002902.....	655
1002562.....	150	1002695.....	506	1002903.....	683
1002563.....	150	1002696.....	506	1002904.....	682
1002564.....	150	1002697.....	501	1002905.....	665
1002583.....	112	1002698.....	501	1002906.....	516
1002584.....	318	1002699.....	501	1002907.....	516
1002585.....	318			1002909.....	120, 770
1002591.....	375	1002700		1002910.....	120, 770
1002592.....	375	1002700.....	501	1002911.....	120, 770
1002594.....	375	1002701.....	501	1002912.....	120, 770
1002596.....	375	1002702.....	501	1002913.....	119, 770
		1002703.....	501	1002914.....	119, 770
1002600		1002704.....	501	1002915.....	294, 771
1002602.....	500	1002705.....	501	1002917.....	294, 771
1002603.....	500	1002785.....	794	1002918.....	294, 771
1002604.....	500	1002791.....	797	1002919.....	294, 771
1002605.....	655	1002792.....	798	1002922.....	413
1002606.....	655			1002925.....	210
1002607.....	228	1002800		1002926.....	210
1002608.....	228	1002803.....	389, 390, 798	1002927.....	210
1002610.....	470	1002842.....	197	1002928.....	197
1002611.....	470	1002843.....	197	1002929.....	197
1002612.....	470	1002844.....	197	1002930.....	197
1002631.....	431	1002845.....	433, 437, 467	1002931.....	217
1002632.....	431	1002853.....	611, 615, 657, 685	1002932.....	217
1002633.....	431	1002854.....	484	1002933.....	217
1002634.....	431	1002855.....	220	1002934.....	287
1002635.....	431	1002856.....	220	1002935.....	287
1002636.....	431	1002858.....	139, 295, 785	1002936.....	287
1002637.....	433	1002859.....	222	1002937.....	160
1002638.....	433	1002860.....	245	1002938.....	160
1002639.....	433	1002861.....	504	1002939.....	160
1002640.....	433	1002862.....	504	1002940.....	330
1002641.....	433	1002863.....	504	1002941.....	330
1002642.....	433	1002864.....	505	1002942.....	221
1002643.....	433	1002865.....	505	1002943.....	221
1002644.....	433	1002866.....	505	1002944.....	279
1002645.....	433	1002867.....	666	1002945.....	279
1002646.....	433	1002868.....	648	1002946.....	156
1002647.....	433	1002869.....	648	1002947.....	156
1002648.....	433	1002870.....	540	1002949.....	169
1002649.....	433	1002871.....	540	1002950.....	169
1002650.....	433	1002873.....	474	1002952.....	640
1002651.....	433	1002874.....	474	1002953.....	640
1002652.....	433	1002875.....	474	1002954.....	640
1002653.....	433	1002876.....	445	1002955.....	640
1002654.....	433	1002877.....	445	1002956.....	575
1002655.....	433	1002878.....	445	1002957.....	575
1002656.....	433	1002882.....	138, 261	1002958.....	575
1002657.....	433	1002884.....	666	1002959.....	575
1002658.....	433	1002890.....	129	1002960.....	244

1002961.....	244	1003035.....	219	1003289.....	270
1002962.....	207	1003040.....	263	1003290.....	270
1002964.....	207	1003041.....	263	1003299.....	384
1002965.....	287	1003042.....	263		
1002967.....	284	1003043.....	263	1003300	
1002968.....	284	1003044.....	141	1003300.....	384
1002969.....	300	1003045.....	141	1003301.....	384
1002970.....	300	1003046.....	141	1003302.....	384
1002971.....	300	1003047.....	141	1003303.....	384
1002973.....	300	1003048.....	140	1003304.....	384
1002974.....	300	1003049.....	140	1003305.....	385
1002975.....	300	1003050.....	140	1003306.....	385
1002976.....	300	1003051.....	140	1003307.....	386
1002977.....	300	1003052.....	263	1003308.....	386
1002978.....	300	1003053.....	263	1003309.....	387
1002979.....	410	1003054.....	263	1003310.....	387
1002980.....	410	1003055.....	263	1003311.....	386
1002981.....	410	1003057.....	357	1003312.....	386
1002982.....	413	1003058.....	358	1003313.....	387
1002983.....	413	1003059.....	358	1003314.....	387
1002984.....	413	1003060.....	358	1003316.....	204
1002985.....	245	1003061.....	357	1003317.....	204
1002986.....	245	1003062.....	359		
1002987.....	245	1003063.....	359	1003400	
1002989.....	650	1003064.....	359	1003416.....	615
1002990.....	650	1003065.....	358	1003417.....	615
1002991.....	576	1003066.....	358	1003418.....	616
1002992.....	576	1003067.....	358	1003419.....	616
1002993.....	211	1003068.....	359	1003420.....	672
1002994.....	139, 295, 783, 785	1003069.....	359	1003421.....	672
1002995.....	783	1003070.....	359	1003422.....	611
		1003073.....	419	1003423.....	611
1003000		1003074.....	419	1003424.....	612
1003001.....	578	1003083.....	419	1003425.....	612
1003004.....	162	1003084.....	419	1003426.....	671
1003005.....	162			1003427.....	671
1003006.....	162	1003100		1003428.....	212
1003007.....	162	1003101.....	811	1003429.....	212
1003008.....	389	1003104.....	796	1003430.....	212
1003009.....	389	1003105.....	796	1003431.....	212
1003010.....	389	1003106.....	794	1003432.....	165
1003011.....	390	1003107.....	179	1003435.....	157
1003012.....	390			1003436.....	157
1003013.....	390	1003200		1003437.....	615
1003014.....	320	1003254.....	797	1003438.....	616
1003015.....	320	1003275.....	148	1003439.....	672
1003016.....	320	1003276.....	148	1003440.....	611
1003017.....	319	1003277.....	148	1003441.....	612
1003018.....	319	1003278.....	148	1003442.....	671
1003019.....	319	1003279.....	149	1003443.....	163
1003022.....	209, 785	1003280.....	149	1003444.....	163
1003023.....	209, 785	1003281.....	149	1003447.....	591
1003028.....	106	1003282.....	149	1003448.....	591
1003029.....	106	1003283.....	270	1003449.....	689
1003030.....	104	1003284.....	270	1003450.....	689
1003031.....	104	1003285.....	270	1003451.....	689
1003032.....	105	1003286.....	270	1003452.....	689
1003033.....	105	1003287.....	270	1003453.....	639
1003034.....	219	1003288.....	270	1003454.....	639

1003455.....	226	1004685.....	433	1004746.....	151
1003456.....	226	1004686.....	448	1004747.....	631
1003457.....	226	1004687.....	448	1004748.....	631
1003458.....	226	1004688.....	448	1004749.....	512
1003459.....	227	1004689.....	448	1004750.....	512
1003460.....	227	1004690.....	441, 773	1004751.....	512
1003466.....	410	1004691.....	441, 773	1004757.....	592
1003467.....	198	1004692.....	441, 773	1004759.....	121
1003468.....	198	1004693.....	441, 773	1004760.....	121
1003479.....	671, 672	1004694.....	389	1004761.....	121
		1004695.....	389	1004762.....	121
1003500		1004696.....	389	1004763.....	122
1003506.....	241	1004697.....	390	1004764.....	122
1003507.....	241	1004698.....	390	1004765.....	123
1003508.....	241	1004699.....	390	1004766.....	123
1003518.....	686			1004767.....	123
1003519.....	686	1004700		1004768.....	123
1003530.....	142	1004700.....	320	1004769.....	443, 772
1003532.....	142	1004701.....	320	1004770.....	443, 772
1003535.....	538	1004702.....	320	1004771.....	443, 772
1003536.....	538	1004703.....	319	1004772.....	443, 772
1003537.....	538	1004704.....	319	1004773.....	107, 155
1003538.....	539	1004705.....	319	1004774.....	107, 155, 277
1003539.....	656	1004706.....	224	1004775.....	107, 155, 277
		1004707.....	224	1004776.....	797
1004600		1004708.....	754	1004777.....	797
1004649.....	666	1004709.....	754	1004780.....	800
1004650.....	636	1004710.....	754	1004781.....	801
1004651.....	636	1004712.....	755	1004782.....	802
1004652.....	601	1004713.....	755	1004783.....	467
1004653.....	684	1004714.....	755	1004784.....	467
1004654.....	541	1004716.....	756	1004785.....	467
1004655.....	541	1004717.....	756		
1004657.....	185	1004718.....	756	1004800	
1004660.....	185	1004719.....	756	1004889.....	738
1004661.....	185	1004720.....	757	1004890.....	738
1004662.....	185	1004721.....	757	1004893.....	739
1004663.....	185	1004722.....	758	1004894.....	739
1004664.....	296	1004723.....	758	1004895.....	739
1004665.....	296	1004725.....	759	1004896.....	747
1004666.....	280	1004726.....	762	1004897.....	747
1004667.....	280	1004727.....	760	1004898.....	747
1004668.....	396	1004729.....	233	1004899.....	747
1004669.....	396	1004730.....	233		
1004670.....	188	1004731.....	233	1004900	
1004671.....	188	1004732.....	193	1004900.....	748
1004672.....	147	1004733.....	190	1004901.....	748
1004673.....	147	1004734.....	761	1004902.....	749
1004674.....	151	1004735.....	761	1004903.....	749
1004675.....	151	1004736.....	761	1004904.....	749
1004676.....	151	1004737.....	763	1004905.....	747
1004677.....	676	1004738.....	215	1004906.....	747
1004678.....	637	1004739.....	215	1004907.....	747
1004679.....	637	1004740.....	206	1004908.....	747
1004680.....	542	1004741.....	206	1004909.....	748
1004681.....	542	1004742.....	206	1004910.....	748
1004682.....	214	1004743.....	206	1004911.....	749
1004683.....	214	1004744.....	151	1004912.....	748
1004684.....	433	1004745.....	151	1004913.....	748

1004914.....	748	1005100	1005294.....	814	
1004915.....	748	1005125.....	635	1005295.....	814
1004916.....	748	1005126.....	635	1005296.....	814
1004917.....	748	1005148.....	624		
1004918.....	741	1005149.....	624	1005300	
1004919.....	741	1005150.....	624	1005301.....	815
1004920.....	741	1005151.....	624	1005302.....	815
1004921.....	741	1005153.....	624	1005303.....	815
1004922.....	741	1005154.....	624	1005304.....	815
1004923.....	741	1005155.....	624	1005305.....	816
1004924.....	742	1005156.....	624	1005306.....	817
1004925.....	742	1005157.....	624	1005307.....	816
1004926.....	742	1005177.....	121	1005308.....	816
1004927.....	743	1005178.....	123	1005309.....	816
1004928.....	743			1005310.....	816
1004929.....	743	1005200		1005311.....	812
1004930.....	743	1005201.....	629	1005312.....	812
1004931.....	743	1005202.....	675	1005313.....	813
1004932.....	745	1005205.....	611, 615, 672	1005314.....	813
1004933.....	471	1005206.....	611, 615, 672	1005315.....	813
1004934.....	471	1005207.....	611, 615, 672	1005316.....	813
1004935.....	471	1005214.....	176	1005317.....	815
1004936.....	471	1005215.....	176	1005318.....	815
1004937.....	431	1005216.....	176	1005380.....	795
1004938.....	431	1005217.....	176	1005381.....	795
1004939.....	433	1005218.....	176	1005382.....	795
1004940.....	433	1005241.....	795	1005383.....	796
1004941.....	433	1005262.....	611, 615, 672	1005384.....	801
1004942.....	433	1005263.....	611, 615, 672	1005387.....	799
1004943.....	433	1005265.....	816	1005390.....	101
1004944.....	433	1005268.....	816	1005391.....	101
1004957.....	666	1005269.....	810	1005392.....	100
1004969.....	185	1005271.....	810	1005394.....	100
1004970.....	113	1005272.....	810	1005395.....	146, 774
1004971.....	232	1005273.....	812	1005396.....	146, 774
1004972.....	812	1005274.....	814	1005397.....	440
1004973.....	812	1005275.....	814	1005399.....	440
1004974.....	812	1005276.....	814		
		1005277.....	814	1005400	
1005000		1005278.....	814	1005400.....	450
1005075.....	813	1005279.....	814	1005401.....	450
1005076.....	813	1005280.....	814	1005402.....	450
1005077.....	813	1005281.....	814	1005407.....	349
1005078.....	813	1005282.....	814	1005408.....	349
1005079.....	813	1005283.....	814	1005409.....	349
1005080.....	813	1005284.....	810	1005410.....	349
1005081.....	813	1005285.....	810	1005415.....	349
1005082.....	813	1005286.....	810	1005416.....	349
1005083.....	813	1005287.....	810	1005417.....	349
1005085.....	322	1005288.....	810	1005418.....	349
1005086.....	322	1005289.....	816	1005423.....	349
1005087.....	323	1005290.....	816	1005424.....	349
1005088.....	323	1005291.....	814	1005425.....	349
1005089.....	690	1005292.....	814	1005426.....	349
1005090.....	690	1005293.....	814	1005435.....	373

1005436.....	373	1006161.....	224
1005439.....	514	1006162.....	224
1005440.....	515	1006171.....	727
1005441.....	579	1006172.....	727
1005442.....	522	1006173.....	727
1005443.....	632	1006174.....	727
1005444.....	795	1006175.....	727
1005445.....	795	1006176.....	727
1005446.....	799	1006178.....	626
1005449.....	798	1006179.....	626
1005496.....	800	1006180.....	518
1005497.....	799	1006181.....	518
		1006182.....	518
1006100		1006183.....	627
1006104.....	730	1006184.....	521
1006105.....	730	1006185.....	118
1006106.....	717	1006186.....	118
1006107.....	717	1006187.....	118
1006120.....	802	1006188.....	118
1006121.....	371	1006189.....	118
1006122.....	371	1006190.....	118
1006123.....	334	1006191.....	589
1006124.....	334	1006192.....	589
1006125.....	334	1006193.....	589
1006126.....	334		
1006127.....	334	1006200	
1006128.....	334	1006202.....	799
1006133.....	797		
1006134.....	797		
1006135.....	807		
1006136.....	807		
1006137.....	807		
1006138.....	807		
1006139.....	807		
1006140.....	807		
1006141.....	807		
1006142.....	807		
1006143.....	807		
1006144.....	807		
1006145.....	807		
1006146.....	807		
1006147.....	807		
1006148.....	807		
1006149.....	807		
1006150.....	807		
1006151.....	807		
1006152.....	807		
1006153.....	807		
1006154.....	807		
1006155.....	472		
1006156.....	472		
1006157.....	444		
1006158.....	444		
1006159.....	166, 444, 472		
1006160.....	166, 444, 472		



NEW PANEL TRACK



NEW QUADRULO



NEW MILANDOS



NEW FLOODI



NEW VARIANT ONE DOUBLE



NEW PARA CONE



1005739 69

1PHASEN

1PHASEN-AUFBAUSCHIENEN	465
1PHASEN-AUFBAUSCHIENEN Zubehör ..	467
1PHASEN-EINBAUSCHIENE	469
1PHASEN-EINBAUSCHIENE Zubehör	469

3PHASEN**EUTRAC®**

EUTRAC® 3PHASEN-AUFBAUSCHIENE...	435
EUTRAC® 3PHASEN-AUFBAUSCHIENE Zubehör	437
EUTRAC® 3PHASEN-EINBAUSCHIENE	439
EUTRAC® 3PHASEN-EINBAUSCHIENE Zubehör	439

S-TRACK

S-TRACK 3PHASEN-AUFBAUSCHIENE DALI	431
S-TRACK 3PHASEN-AUFBAUSCHIENE DALI Zubehör	433

A

ABRIDOR 60 Pole	576
ABRIDOR 100 Pole	576
ABRIDOR SENSOR WL	650
ABRIDOR WL	650
ACCANTO CL, E27	279
ACCANTO PD, E27	156
ACCANTO WL, E27	221
ADEGAN FL, E27	555
ADEGAN MANILA FL, E27	554
ADI EL	700
AINOS CW	688
AINOS CW SENSOR	688
AINOS CW SENSOR, quadratisch	689
AINOS CW, quadratisch	689
AKALO D83 EL, PHASE	407
ALPA CONE 100 Pole, E27	557
ALPA MUSHROOM 45 Pole, E27	557
ALPA MUSHROOM 75 Pole, E27	557
ALTRA DICE CL, QPAR51	274
ALTRA DICE CW, double, QPAR51	274, 308
ALTRA DICE TRACK 1Ph., QPAR51	485
ALTRA DICE TRACK 3Ph., QPAR51	453
ANDREAS WL, QT-DE12	210
ANELA CL, PHASE	287
ANELA PD, PHASE	164
ANGOLUX SENSOR WL	642
ANGOLUX WL	642
ANILA EASYTEC® II, QPAR51	494
APONI 90 Pole, PHASE	558
APONI 120 Pole, PHASE	558
APONI WL, PHASE	658
ARLINA 60 WL	208
ARLINA 130 WL	208
ARROCK ARC Pole, QPAR51	535
ARROCK GRANITE 40 Pole, square, E27 ..	534
ARROCK GRANITE 70 Pole, square, E27 ..	534
ARROCK SLOT	537
ARROCK STONE 50 Pole	536
ARROCK STONE 75 Pole	536
ASMARA LV, QR-C51	502
ASSO 70 WL	200
ASSO 300 WL, PHASE	201
ASSO WL, PHASE	201
ASTINA CL, QPAR51	287
ASTINA PD, QPAR51	160
ASTINA STEEL WL, QPAR51	641
ASTINA UP/DOWN WL, QPAR51	217
ASTINA WL, QPAR51	641
ASTO CW, double, QPAR51	316
ASTO CW, quad, QPAR51	316
ASTO CW, single, QPAR51	316
ASTO CW, triple, QPAR51	316
ASTO TUBE CW, double, QPAR51	311
ASTO TUBE CW, single, QPAR51	311
ASTO TUBE CW, triple, QPAR51	311
AVO CW, double, QPAR51	315

AVO CW, quad, QPAR51	315
AVO CW, single, QPAR51	315
AVO CW, triple, QPAR51	315
AVO TRACK 1Ph., QPAR51	479
AVO TRACK 3Ph., QPAR51	459

B

BASKET WL, E27	211
BATO 35 CW, E27	333
BATO 45 CW, E27	288
BATTEN 120 CW	334
BATTEN 60 CW	334
BENA 120 CW	339
BENA 150 CW	339
BIG NAILS 50 POLE, E27	560
BIG NAILS 80 POLE, E27	560
BIG NAILS WL, E27	660
BIG NAUTILUS SP, rund, QPAR51	593
BIG PLOT Abdeckung, 2er	728
BIG PLOT Abdeckung, 4er	728
BIG PLOT Module	728
BIG QUAD Up/Down WL	635
BIG QUAD WL	622, 633
BIG THEO CL	674
BIG THEO CL, QPAR111	674
BIG THEO UP/DOWN WL, QPAR111	619
BIG THEO WL	621
BIG THEO WL, QPAR111	621
BIMA 1Ph., double, QPAR51	482
BIMA 1Ph., single, QPAR51	482
BIMA 3Ph., double, QPAR51	456
BIMA 3Ph., single, QPAR51	456
BIMA EASYTEC® II, double, QPAR51	492
BIMA EASYTEC® II, single, QPAR51	492
BOOKAT Pole, PHASE	579
BOOKAT WL	632
BOX UP/DOWN WL, QT-DE12	652
BOX-L WL	686
BOX-L WL, E27	652
BRICK DOWNUNDER EL	703
BRICK DOWNUNDER EL, E14	703
BRICK EL, asymmetrisch	702
BRICK EL, symmetrisch	702
BRICK MESH EL, E14	702
BULAN CW, E14	691
BULAN GRID CW, E27	691

C

C-POL POLE, E27	566
C-POL WL, E27	659
CARISO WL, PHASE	203
CHROMBO WL, PHASE	204
COMET LED LV	506
COMET LV, QR-C51	506
CONE FL, E27	551
CONNECTED LED PANEL 595x595mm, UGR<19	418
CONNECTED LED PANEL 620x620mm, UGR<19	418
CONTONE® DL, rund, starr, PHASE	398
CONTONE® DL, rund, verstellbar, PHASE ..	398
COSMIC LV, QR-C51	503
COUPA FLEX WL	222
COUPA WL, QT14	222
CUBIX FL, QPAR51	551

D**DASAR®**

DASAR® 70 EL, quadratisch, QPAR51	721
DASAR® 80 EL, rund/quadratisch, QPAR51	721
DASAR® 215 EL, rund, E27	722
DASAR® 215 EL, rund/quadratisch, QPAR111	722
DASAR® 218 EL, QR111	722
DASAR® 255 EL	718
DASAR® 270 EL, asymmetrisch	719
DASAR® 270 EL, symmetrisch	719

DASAR® 370 EL, rund	723
DASAR® 920 EL	718
DASAR® EXACT 116 EL, rund/quadratisch, QPAR51	721
DASAR® FLAT 80 EL	716
DASAR® FLAT 120 EL	717
DASAR® PROJECTOR SP, 12/24V	598
DASAR® PROJECTOR SP, 230V	598

DEKLED EL	404
DELWA WL	647
DENA 30 WL, E14	211
DIO FLEX PLATE WL	228, 229
DIO FLEX PLATE WL QPAR51	228
DIRETO 60 WL, PHASE	206
DIRETO 90 WL, PHASE	206
DISPLAY ADL 50 QPAR51	245
DL 126 EL	394
DOLIX OUT EL, quadratisch, QPAR51	405, 713
DOLIX OUT EL, rund, QPAR51	405, 713
DORISA 30	238
DORISA 50	239
DOWNUNDER OUT L EL	701
DOWNUNDER OUT M EL	701
DOWNUNDER OUT S EL	701
DOWNUNDER OUT WL, quadratisch	648
DOWNUNDER OUT WL, rund	648
DOWNUNDER PUR 80 EL	412
DOWNUNDER PUR 150 EL	412
DURNO	504

E**EASYTEC® II**

EASYTEC® II Schiene	491
EASYTEC® II Schiene, Zubehör	491

ENOLA

ENOLA B CL, QPAR51	281
ENOLA B CW, double, QPAR51	307
ENOLA B CW, single, QPAR51	307
ENOLA B PD, QPAR51	161, 481
ENOLA B TRACK 1Ph., QPAR51	480
ENOLA B WL, QPAR51	217
ENOLA C CL	281
ENOLA C CL, PHASE	281
ENOLA C POLE	580
ENOLA C TRACK 1Ph	480
ENOLA C TRACK 3Ph	459
ENOLA PD, E27	161
ENOLA ROUND S CL	671
ENOLA ROUND S WL, single	611
ENOLA ROUND L CL	671
ENOLA ROUND L WL, single	611
ENOLA ROUND M CL	671
ENOLA ROUND M WL, single	611
ENOLA SQUARE S CL	672
ENOLA SQUARE S WL, single	615
ENOLA SQUARE M CL	672
ENOLA SQUARE M WL, single	615
ENOLA SQUARE L CL	672
ENOLA SQUARE L WL, single	615
ENOLA Zubehör	617

ESKINA 30 Pole	516
ESKINA 80 Pole	516
ESKINA D Display, PHASE	665
ESKINA FRAME 45 Pole, single	512
ESKINA FRAME 75 Pole, double	512
ESKINA FRAME 75 Pole, single	512
ESKINA FRAME 125 Pole, double	514
ESKINA FRAME 175 Pole, double	515
ESKINA FRAME WL	631
ESKINA FRAME WL, double	631
ESKINA SPOT CW, PHASE	683
ESKINA SPOT SENSOR CW, PHASE	682
EURO CUBE 3Ph	451
EURO SPOT TRACK 1Ph., QPAR51	485
EURO SPOT TRACK 3Ph., QPAR111	452
EURO SPOT TRACK 3Ph., QPAR51	452

F

F-POL POLE, E27	567
F-POL WL, E27.....	659

FENDA

FENDA 15 cm, rund	107, 155
FENDA 30 cm, rund	107, 155, 277
FENDA 45 cm, rund	107, 155, 277
FENDA BOW BASIS FL, E27	106
FENDA Deckenrosette, E27	276
FENDA FL, E27	104, 105
FENDA Glasschirm.....	154
FENDA Halbschirm	218
FENDA Ø 20 cm, rund	218
FENDA Ø 40 cm, rund	107, 154
FENDA Ø 70 cm, rund	107, 155, 277
FENDA PD, E27	154
FENDA TL, E27	104, 105
FENDA WL, Basis, E27	218, 219
FENDA WL, E27	219

FERA 25 CL.....	285
FERA 25 CL, DALI	284
FITU CUBE WL, E27	215
FITU CW, E27	318
FITU FL, E27	109
FITU MIX & MATCH Zubehör	151
FITU PD, E27	150
FITU TL, E27	109
FITU Wandhalter	214
FITU WL, E27	214
FLAC BEAM® SP.....	591
FLATT 100 POLE	575
FLATT 65 POLE	575
FLATT SENSOR WL.....	640
FLATT WL.....	640
FLOODI L SP	589
FLOODI M SP	589
FLOODI S SP	589
FORCHINI 50 PD, E27	170
FORCHINI 70 PD, E27	170
FORCHINI M 40 PD, E27	171
FORCHINI M 40 TRACK 1Ph., E27.....	477
FORCHINI M 40 TRACK 3Ph., PD, E27	447
FORCHINI M 50 PD, E27	171
FRAME BASIC RL.....	409
FRAME BASIC RL, HV	409
FRAME BASIC SET RL.....	408
FRAME CURVE EL.....	408
FRAME CURVE EL, HV	408

G

GALEN 120 SP.....	591
GALEN 60 SP	591
GIMBLE OUT EL.....	724
GLASSA CW, quadratisch, E27	332
GLENOS PD, 1m, 1-10V	143
GLENOS PD, 2m, 1-10V	143
GLENOS® 60 WL	241
GLOO PURE 27 Pole, E27	545
GLOO PURE 44 Pole, E27	545
GLOO PURE 70 Pole, E27	545
GLOO PURE WL, E27	658
GRAFIT 30 Pole, E27	521
GRAFIT 30 Pole, rund, E27	518
GRAFIT 60 Pole, E27	521
GRAFIT 60 Pole, rund, E27	518
GRAFIT 90 Pole, E27	521
GRAFIT 90 Pole, rund, E27	518
GRAFIT SENSOR WL, eckig, E27	627
GRAFIT SENSOR WL, rund, E27	626
GRAFIT WL, eckig, E27	627
GRAFIT WL, rund, E27.....	626

GRAZIA LED-Strips

GRAZIA IP FLEXSTRIP, 24V	761
GRAZIA IP FLEXSTRIP, RGBW, 24V	763
GRAZIA IP FLEXSTRIP, Tunable white, 24V	762

GRAZIA PRO FLEXSTRIP, 24V	756
GRAZIA PRO FLEXSTRIP, RGBW, 24V	760
GRAZIA PRO FLEXSTRIP, Tunable white, 24V	759
GRAZIA PRO MAX FLEXSTRIP, 24V	757, 758

GRAZIA Profile

GRAZIA 10 Aufbauprofil, Flach	735
GRAZIA 10 Aufbauprofil, Standard	735
GRAZIA 10 Einbauprofil.....	735
GRAZIA 10 Zubehör.....	736, 737
GRAZIA 10 EDGE Aufbauprofil.....	738
GRAZIA 10 EDGE Zubehör.....	739
GRAZIA 20 Aufbauprofil, Flach	741
GRAZIA 20 Aufbauprofil, Standard	741
GRAZIA 20 Einbauprofil.....	742
GRAZIA 20 Zubehör.....	743, 744, 745
GRAZIA 60 Aufbauprofil	747
GRAZIA 60 Einbauprofil.....	747
GRAZIA 60 Zubehör.....	748, 749

H

H-LIGHT DL, oval, PHASE	399
H-LIGHT DL, rund, PHASE.....	399
H-POL 30 Pole.....	572
H-POL 60 Pole.....	572
H-POL TWIN 30 Pole.....	573
H-POL TWIN 60 Pole	573
HELIA 30 PD.....	158
HELIA 30 PD, PHASE.....	158
HELIA 40 PD.....	159
HELIA 40 PD, PHASE.....	159
HELIA 50 TRACK 1Ph.	483
HELIA 50 TRACK 3Ph.	457
HELIA AMBIENT 35 PD.....	157
HELIA AMBIENT 35 PD, PHASE.....	157
HELIA CW, double, PHASE	299, 685
HELIA CW, single, PHASE.....	299, 685
HELIA EL	400
HELIA Pole, double, PHASE.....	581, 582
HELIA Pole, single, PHASE.....	581, 582
HELIA SPOT S SP, single, PHASE	599
HELIA SPOT L SP, single, PHASE	599
HORN DL, double, QPAR51	371
HORN DL, GU10, Blower Door getestet ...	373
HORN DL, single, asymmetrisch, QPAR51	371
HORN DL, single, QPAR51.....	370, 372
HORN EL, single, QPAR51	372
HORN MAGNA	375
HORN MINI EL	370
HORN-T EL, QPAR111	374

I

I-PENDANT PRO PD, 1195x295mm, DALI 140	
IMPERVA 120 CW.....	692
IMPERVA 150 CW.....	692
INDA CW, QPAR51	308
IPERI 50 Pole.....	577
IPERI WL	662

K

KADUX EL, double, 1-10V.....	380
KADUX EL, double, PHASE.....	379
KADUX EL, double, QPAR111	378
KADUX EL, double, QPAR51.....	376
KADUX EL, single, 1-10V	380
KADUX EL, single, PHASE	379
KADUX EL, single, QPAR111.....	378
KADUX EL, single, QPAR51	376
KADUX EL, triple, PHASE.....	379
KADUX EL, triple, QPAR51	376
KALU CW, double, PHASE.....	303
KALU CW, double, QPAR111	304
KALU CW, quad, PHASE	303
KALU CW, quad, QPAR111.....	304
KALU CW, single, PHASE.....	303
KALU CW, single, QPAR111.....	304
KALU CW, triple, PHASE.....	303

KALU CW, triple, QPAR111	304
KALU TRACK 1Ph., PHASE	484
KALU TRACK 1Ph., QPAR111.....	484
KALU TRACK 3Ph., PHASE	454
KALU TRACK 3Ph., QPAR111.....	454
KALU TRACK 3Ph., QR111	454
KAMUELA ECO EL, rund, PHASE	406, 710
KANO EASYTEC® II, QPAR51.....	492
KARDAMOD CL, double, quadratisch, QPAR111.....	275
KARDAMOD CL, single, quadratisch, QPAR111.....	275
KARPO 30 CW, single.....	296
KARPO 30 CW, single, PHASE.....	296
KARPO 30 EL.....	400
KARPO 30 WL, single	225
KARPO FL.....	108
KARPO GOOSE WL.....	224
KARPO MAGN CW, single, PHASE	224
KARPO TL.....	108
KARPO WL.....	225
KENKUA SPOT WL, E27	220
KENKUA WL, E27	220
KERAS ELT WL, E27	661
KINI EL, PHASE.....	407, 709

L

L-LINE 120 WL	242
L-LINE 60 WL	242
L-LINE OUT 30 FL, vertikal	538
L-LINE OUT 50 Pole, horizontal	538
L-LINE OUT 60 FL, vertikal	538
L-LINE OUT 80 Pole, horizontal	539
L-LINE OUT WL	656
LED PANEL 600x600mm	419
LED PANEL 620x620mm	419

LEUCHTMITTEL

LED A60 E27	815
LED A60 E27, Mirrorhead, Chrom	816
LED A60 E27, RGBW, smart	815
LED A60 E27, tunable 2700-6500K, smart	815
LED C35 E14.....	810
LED G125 E27, Mirrorhead, Chrom.....	817
LED G53	811
LED G95 E27.....	816
LED QPAR 111 GU10	814
LED QPAR111 GU10, RGBW, smart	813
LED QPAR111 GU10, RGBW, smart	813
LED QPAR111 GU10, tunable 2700-6500K, smart	813
LED QPAR51 GU10	812,813
LED QPAR51 GU10, RGBW, smart	812
LED QPAR51 GU10, tunable 2700-6500K, smart	812
LED QR51 GU5,3	811
LED QT-DE12 R7S, 118 mm.....	810
LED QT-DE12 R7S, 78 mm.....	810
LED QT14 G9	810
LED SPIKE SP	601
LED SPOT SP	666
LED ST58 E27	816
LED ST64 E27	816
LED T32 Filament GU10.....	811
LED T38 E27	816
LED T45 E27	816
LED TCR-TSE GX53.....	810

LIGHT EYE® 150 3Ph., PD, QPAR111.....	446, 476
LIGHT EYE® 150 EASYTEC® II, PD, QPAR111.....	495
LIGHT EYE® 150 PD, QPAR111.....	172
LIGHT EYE® 150 TRACK 3Ph., QPAR111.....	446
LIGHT EYE® 150 TRACK EASYTEC® II, QPAR111.....	495
LIGHT EYE® 90 1Ph., QPAR51	476
LIGHT EYE® 90 PD, GU10.....	172
LIGHTPOINT EL.....	401

LIPA CW, PHASE.....	690
LIPSY® 30 CW, Dome.....	326
LIPSY® 30 CW, Drum.....	329
LIPSY® 40 CW, Dome.....	326
LIPSY® 40 CW, Drum.....	329
LIPSY® 40 CW, Drum, DALI.....	330
LIPSY® 50 CW, Dome.....	326
LIPSY® 50 CW, Drum.....	329
LIPSY® 50 CW, Drum, DALI.....	330
LISENNE 40 Pole, E27.....	553
LISENNE 70 Pole, E27.....	553
LISENNE PD, E27.....	164
LISENNE WL, E27.....	213
LOGS 40 Pole.....	517
LOGS 70 Pole.....	517
LOGS IN L WL, PHASE.....	197
LOGS IN WL.....	196
LOGS IN WL, PHASE.....	196
LOGS WL.....	652
LONG GRILL CW.....	336

M

MAGANDA TL.....	113
MAGANDA WL.....	232
MALANG CW.....	139, 295
MANA 40 Schirm, rund.....	185
MANA 60 Schirm, rund.....	185
MANA BASE rund.....	185
MANA BASE WL, rund, PHASE.....	185
MANA OUT WL, PHASE.....	655
MANA Schirm.....	186, 187
MANA WL, Basis.....	187
MANA WL, Basis, PHASE.....	186, 187
MARONA WL, PHASE.....	288
MARYLIN 40/60/90 WL.....	235
MECANICA PLUS FL.....	111
MECANICA PLUS TL.....	111

MEDO

MEDO 30 AMBIENT CW, DALI.....	136, 260
MEDO 30 AMBIENT CW, PHASE.....	134, 258
MEDO 30 CL, 1-10V.....	130, 254
MEDO 30 CL, PHASE.....	133, 257
MEDO 30 EL, Einbaurahmen.....	416
MEDO 30 EL, Rahmenlos.....	414
MEDO 40 AMBIENT CW, DALI.....	136, 260
MEDO 40 AMBIENT CW, PHASE.....	134, 258
MEDO 40 CL, 1-10V.....	131, 255
MEDO 40 CL, PHASE.....	133, 257
MEDO 40 EL, Einbaurahmen.....	416
MEDO 40 EL, Rahmenlos.....	415
MEDO 60 AMBIENT CW, DALI.....	136, 260
MEDO 60 AMBIENT CW, PHASE.....	134, 258
MEDO 60 CL, 1-10V.....	131, 255
MEDO 60 CL, quadratisch, 1-10V.....	132, 256
MEDO 60 CL, quadratisch, DALI.....	138, 261
MEDO 60 EL, Einbaurahmen.....	416
MEDO 60 EL, Rahmenlos.....	415
MEDO 90 AMBIENT CL, DALI.....	137, 261
MEDO 90 AMBIENT CL, PHASE.....	135, 259
MEDO 90 CL, 1-10V.....	131, 255
MEDO 90 EL, Einbaurahmen.....	417
MEDO 90 EL, Rahmenlos.....	415
MEDO RING 60 PD, 1-10V.....	128
MEDO RING 60 PD, DALI.....	129
MEDO RING 90 PD, 1-10V.....	128

MELAN CW, E27.....	332
MERADO FLOOD WL, PHASE.....	231
MERIDIAN BOX SENSOR WL, E27.....	630
MERIDIAN BOX WL, E27.....	630
MIBO UP/DOWN WL, QT14.....	237
MILANDOS 4 DL.....	349
MILANDOS 6 DL.....	349
MILANDOS 8 DL.....	349
MOBALA EL.....	413
MOLAT CL, E27.....	677
MOLAT PD, E27.....	552
MOLAT Pole, E27.....	552

MOLAT WL, E27.....	657
MYRA CW, single, QPAR51.....	666
MYRA DISPLAY WL, curved, QPAR51.....	665
MYRA SPOT Double, GU10.....	583
MYRA UP/DOWN WL, QPAR51.....	644
MYRA WL, double, QPAR51.....	686

N

NAGY 75 CL, QPAR51.....	287
NAUTILUS 10 SP, quadratisch.....	597
NAUTILUS 10 SP, rund, QPAR51.....	593, 594
NAUTILUS 10 SPOT LED SP.....	595
NAUTILUS 10 SPOT SP, QPAR51.....	595
NAUTILUS SP, QR-C51.....	595
NAUTILUS WL QPAR51.....	666
NEPRO DISPLAY QT-DE12.....	245
NEW FLAT WL, RGB-W.....	209

NEW TRIA

NEW TRIA 45 DL, rund.....	356
NEW TRIA 45 Single, quadratisch, CS.....	356
NEW TRIA 68 DL, eckig.....	357, 359
NEW TRIA 68 DL, eckig, PHASE.....	359, 361
NEW TRIA 68 DL, eckig, QPAR51.....	350
NEW TRIA 68 DL, rund.....	357, 358
NEW TRIA 68 DL, rund, PHASE.....	360, 361
NEW TRIA 68 DL, rund, QPAR51.....	350
NEW TRIA 77 DL, eckig.....	362, 363
NEW TRIA 77 DL, rund.....	362
NEW TRIA 78 DL, eckig, QPAR51.....	352, 353
NEW TRIA 78 DL, rund, QPAR51.....	352
NEW TRIA 78 XL DL, eckig, QPAR51.....	351
NEW TRIA 78 XL DL, rund, QPAR51.....	351
NEW TRIA 110 DL, eckig, PHASE.....	366, 367
NEW TRIA 110 DL, rund, PHASE.....	366
NEW TRIA 150 DL, eckig, 1-10V.....	369
NEW TRIA 150 DL, eckig, QPAR111.....	355
NEW TRIA 150 DL, rund, 1-10V.....	368
NEW TRIA 150 DL, rund, QPAR111.....	355
NEW TRIA 155 DL, Double.....	364, 365
NEW TRIA 155 DL, Double, QPAR51.....	354
NEW TRIA 300 DL, Double, QPAR111.....	355

NOBLO CW, double, PHASE.....	300
NOBLO CW, PHASE.....	300
NOBLO CW, single, PHASE.....	300
NOBLO CW, triple, PHASE.....	300
NOBLO SPOT 1Ph.....	483
NOBLO SPOT 1Ph., Triple Track Set.....	470
NOBLO SPOT 3Ph.....	458
NOBLO SPOT LV, Rope Track.....	506
NOTAPO L RL.....	410
NOTAPO S RL.....	410
NOYA PD, PHASE.....	142

NUMINOS®

NUMINOS® 3Ph.....	62-71
NUMINOS® CL.....	74-87
NUMINOS® CW.....	72-73
NUMINOS® DL.....	28-61
NUMINOS® PD.....	88-95
NUMINOS® Zubehör.....	58-61

O

OCCULDAS 13 DL, indirekt, PHASE.....	273
OCCULDAS 14 EL, indirekt, PHASE.....	397
OCCULDAS 23 DL, indirekt, PHASE.....	273
OCCULDAS 23 EL, indirekt, PHASE.....	397
OCULUS CL, Move, PHASE.....	396
OCULUS CL, PHASE.....	280
OCULUS CW, PHASE.....	296
OCULUS PD, single, PHASE.....	147
OCULUS UP/DOWN WL, PHASE.....	188
ONE 40 CW, DALI.....	294
ONE 40 TRACK 3Ph., DALI.....	443
ONE 60 PD, DALI.....	120
ONE 60 PD, DALI, up/down.....	121
ONE 60 PD, PHASE, up/down.....	121
ONE 60 WL, DALI.....	294

ONE 80 PD, DALI.....	120
ONE 80 PD, DALI, up/down.....	122
ONE DOUBLE PD, DALI, up/down.....	123
ONE DOUBLE PD, PHASE, up/down.....	123
ONE LINEAR 100 PD, PHASE, up/down.....	118
ONE LINEAR 140 PD, PHASE, up/down.....	118
ONE TRIPLE PD, DALI.....	119
ORBIT LV, QR111.....	504
ORDI SENSOR WL.....	651
ORDI WL.....	651
OSSA 180 WL, QT-DE12.....	202
OSSA 300 WL, QT-DE12.....	202
OTOS GLAS Pole, E27.....	550
OUT 65 EL, rund, PHASE.....	423, 708
OUT-BEAM FRAME SP.....	686
OVALISK 75 Pole.....	542
OVALISK 100 Pole.....	542
OVALISK CL.....	676
OVALISK SENSOR WL.....	637
OVALISK WL.....	637

P

P-LIGHT CW.....	340, 341
P-LIGHT EL.....	420
PANEL 60 CL, rund, DALI.....	263
PANEL 60 CL, rund, PHASE.....	262
PANEL 60 PD, rund, DALI.....	141
PANEL CL, 1200x300mm, DALI.....	263
PANEL CL, 1200x300mm, PHASE.....	262
PANEL TRACK 1Ph., eckig.....	471
PANEL TRACK 1Ph., rund.....	471
PANTILO 20 PD, E27.....	162
PANTILO 28 PD, E27.....	162
PANTILO CONVEX 29.....	163
PANTILO CONVEX 40 PD, E27.....	163
PARA 380 PD, E27.....	179
PARA CONE 14 1Ph., PD, QPAR51.....	474
PARA CONE 14 1Ph., QPAR51.....	474
PARA CONE 14 3Ph., PD, QPAR51.....	445
PARA CONE 14 3Ph., QPAR111.....	445
PARA CONE 30 PD, E27.....	167
PARA CONE GL 1Ph., GU10.....	472
PARA CONE GL 3Ph., GU10.....	444
PARA CONE GL PD, GU10.....	166, 444, 472
PARA DOME PD, E27.....	176
PARA DOME Schirm.....	176
PARA FLAC PD/CL.....	179
PARA FLAC PD/CL, DALI.....	179
PATTA-F EL, quadratisch, PHASE.....	422, 708
PATTA-F EL, rund, PHASE.....	422, 708
PATTA-I DL, eckig, PHASE.....	420, 706
PATTA-I EL, quadratisch, PHASE.....	421, 707
PATTA-I EL, rund, PHASE.....	420, 421, 706, 707

PEMA® WL.....	638, 639
PEMA® WL, E27.....	639
PHELIA 25 PD, E27.....	169
PHELIA 30 PD, E27.....	169
PHELIA FL, E27.....	110
PHELIA TL, QPAR51.....	110
PHELIA WL, QPAR51.....	230
PHOTONIA CL, E27.....	677
PHOTONIA PD, E27.....	548
PHOTONIA Pole, E27.....	549
PHOTONIA TL, E27.....	548
PHOTONIA WL, E27.....	657
PIKA DL, rund, QPAR51, schwenkbar.....	395
PIKA DL, rund, QPAR51, starr.....	395

PLASTRA

PLASTRA 101 WL, E14.....	194
PLASTRA 104 CL, E27.....	283
PLASTRA 104 WL, QT14.....	194
PLASTRA 105 CL, E27.....	282
PLASTRA 25 PD, rund, TCR-TSE.....	175
PLASTRA CL, PHASE.....	282
PLASTRA CL, QPAR51.....	282
PLASTRA CW, rund.....	193
PLASTRA RL, quadratisch, QPAR51.....	403

PLASTRA RL, rund, QPAR51	402
PLASTRA WL, Cube, QT14.....	190
PLASTRA WL, Cubes.....	190
PLASTRA WL, Curve, QT-DE12.....	194
PLASTRA WL, E14.....	191
PLASTRA WL, eckig	223
PLASTRA WL, halbrund	193
PLASTRA WL, QPAR51	193
PLASTRA WL, rechteckig, QT-DE12.....	191

PLYTTA	505
POWER TRAIL-LITE® EL, rund/quadratisch.....	724
PURI CW, double, QPAR51	312
PURI CW, quad, QPAR51.....	312
PURI CW, single, QPAR51.....	312
PURI CW, triple, QPAR51	312
PURI TRACK 1Ph., QPAR51	478
PURI TRACK 1Ph., Triple Track Set	470
PURI TRACK 3Ph., QPAR51	453
PURIA TRACK 1Ph., QPAR51	478
PURISA WL, E27	211

Q

Q-LINE® CL, 1m, BAP, PHASE	264
Q-LINE® CL, 2m, BAP, PHASE.....	265
Q-LINE® PD, 1m, BAP, PHASE.....	144, 145
Q-LINE® PD, 2m, BAP, PHASE.....	144, 145
Q-LINE® PD, DALI, single	145
Q-LINE® WL.....	243
QUAD FRAME 14 WL.....	198
QUAD FRAME 19 WL.....	198
QUAD FRAME 9 WL	410
QUAD POLE	578
QUAD UP/DOWN 12 WL.....	634
QUAD UP/DOWN 15 WL.....	634
QUAD WL.....	633
QUADRASS PD, E27.....	165
QUADRASS SPOT WL, E27	212
QUADRASS WL, E27	212
QUADRASYL 75 Pole, TCR-TSE	577
QUADRASYL WL, TCR-TSE	662
QUADRULO CL	675
QUADRULO FL.....	522
QUADRULO SENSOR WL, E27	629
QUADRULO WL.....	629
QUADRULO WL, E27	629

R

RASCALI 45 Pole	579
RASCALI 65 Pole.....	579
RASCALI WL	661
RETRATO WL, PHASE	244
ROCCI 200 EL, rund/quadratisch	730
ROCCI EL, quadratisch	730
ROCCI EL, rund	730
ROTOBALL 25 CL, E27	289
ROTOBALL 25 FL, E27	546
ROTOBALL 25 PD, E27.....	174
ROTOBALL 40 CL, E27.....	289
ROTOBALL 40 FL, E27	546
ROTOBALL 40 PD, E27	174
ROTOBALL 50 FL, E27	546
ROTOBALL 50 PD, E27.....	174
ROX ACRYL 30	561
ROX ACRYL 60	561
ROX ACRYL 90	561
ROX CL, GX53.....	679
ROX CL, QPAR111	679
ROX UP/DOWN WL, QPAR111	645
ROX WL, QPAR111.....	645
RUBA 27/42 CW.....	690
RUSTY® UP/DOWN WL, quadratisch.....	636
RUSTY® UP/DOWN WL, rund	636
RUSTY® 40 Pole	528, 532
RUSTY® 40 Pole, E27	529, 533
RUSTY® 70 Pole	528, 532
RUSTY® 70 Pole, E27	529, 533
RUSTY® CONE 24 FL, E14.....	530

RUSTY® CONE 40 Pole, E27	530
RUSTY® CONE 70 Pole, E27	530
RUSTY® PATHLIGHT 40 Pole	527
RUSTY® PATHLIGHT 70 Pole	527
RUSTY® PATHLIGHT Pole, TCR-TSE	527
RUSTY® SLOT 50 Pole.....	524
RUSTY® SLOT 50 Pole, E27	524
RUSTY® SLOT 80 Pole.....	524
RUSTY® SLOT 80 Pole, E27	525

S

SAIL WL	655
SALUNA LV, QR-C51	503
SAMRINA SP, single, GU10.....	592
SEDO 7 WL	207
SEDO 14 WL	207
SEDO 21 WL	207
SENER 12 CW, quadratisch, PHASE.....	319
SENER 12 CW, rund, PHASE.....	320
SENER 12 EL, rund	389, 390
SENER 18 CW, quadratisch, PHASE.....	319
SENER 18 CW, rund, PHASE.....	320
SENER 18 EL, rund	389, 390
SENER 24 CW, quadratisch, PHASE.....	319
SENER 24 CW, rund, PHASE.....	320
SENER 24 EL, rund	389, 390
SHELL 15 WL, PHASE.....	199
SHELL 30 WL, PHASE.....	199
SIGHT 60 CW	337
SIGHT 115 CW	337
SIGHT MOVE 3Ph., DALI.....	441
SIGHT MOVE 3Ph.....	448
SIGHT TRACK 3Ph.	450
SIGHT TRACK 3Ph., DALI	440
SIMA CW, quadratisch, PHASE	323
SIMA CW, quadratisch, Sensor	323
SIMA CW, rund, PHASE	322
SIMA CW, rund, Sensor	322
SITRA 360 CW, TCR-TSE	684
SITRA 360 Pole, TCR-TSE.....	583
SITRA 360 SPIKE SP, double, TCR-TSE ..	603
SITRA 360 SPIKE SP, single, TCR-TSE	602
SITRA CL, TCR-TSE.....	679
SITRA CUBE WL.....	622
SITRA CUBE WL, TCR-TSE.....	622
SITRA S WL, single, eckig	624
SITRA M WL, up/down, eckig	624
SITRA L WL, up/down, eckig	624
SITRA UP/DOWN WL.....	644
SITRA UP/DOWN WL, TCR-TSE.....	644
SITRA WL, TCR-TSE	661
SLOTBOX 40 Pole.....	574
SLOTBOX 70 Pole.....	574
SLOTS 45 Pole	570
SLOTS 65 Pole	571
SLOTS WL.....	647
SMALL PLOT Abdeckung, 2er.....	727
SMALL PLOT Abdeckung, 4er.....	727
SMALL PLOT Module.....	727
SOLASTO EL, rund	731
SOLID CUBE WL, QT14.....	216
SOMNILA FLEX WL, links.....	227
SOMNILA FLEX WL, rechts	227
SOMNILA SPOT WL, links.....	226
SOMNILA SPOT WL, rechts	226
SOPRANA CL, E27	278
SPOT 79 CW, QPAR51	308
SPOT DISPLAY E27	245
SQUARE POLE 30 Pole, E27	568
SQUARE POLE 60 Pole, E27	568
SQUARE POLE 90 Pole, E27	568
SQUARE TURN WL, G9.....	662
SQUARE WL, E27.....	660
STRUCTEC ZOOM 3 Ph.....	457
SUN / BIG SUN PD, E27	173
SUPROS 78 CL, PHASE	271
SUPROS 78 EL, Move, PHASE	383
SUPROS 78 FL, PHASE	382
SUPROS 78 PD.....	148
SUPROS 78 UP/DOWN WL, PHASE.....	189

SUPROS CL, Move.....	270
SUPROS DL	384, 385
SUPROS DL, Move.....	386, 387
SUPROS PD.....	148, 149
SYNA SP	601
SYROS LV, QR-C51	503

T

TEC KALU TRACK 3Ph., double, PHASE....	459
TELESKOP LV, QR-C51	502
TENORA CL, E27.....	278

TENSEO Niedervolt-Seil

TENSEO Niedervolt-Seil	500
TENSEO Niedervolt-Seil Zubehör	501

TERANG 200 CW	692
THEO BRACKET 50 Pole	541
THEO BRACKET 70 Pole	541
THEO BRACKET CW	684
THEO BRACKET SP	601
THEO PATHLIGHT Pole, double	540
THEO PATHLIGHT Pole, single	540
THEO UP/DOWN WL, QPAR51	216, 618
THEO WL, QPAR51	620
TODAY PRO Display.....	665
TONGA® 1Ph., PD, E14.....	475
TONGA® EASYTEC® II, PD, E14.....	494
TONGA® PD, E14.....	165
TONILA TL.....	112
TOTHEE CW, PHASE	298
TRAIL-LITE® 60 EL.....	724
TRIADDEM PD, E27	156
TRILEDO CL, double, quadratisch.....	269
TRILEDO CL, double, quadratisch, QPAR51.....	266
TRILEDO CL, single, quadratisch.....	269
TRILEDO CL, single, quadratisch, QPAR51.....	266
TRILEDO CL, single, rund	269
TRILEDO CL, single, rund, QPAR51	266
TRUKKO 60 WL.....	234
TRUKKO 90 WL.....	234
TRUKKO WL, rechteckig.....	233
TRUKKO WL, rund.....	233
TRUST 30 Pole	559
TRUST 60 Pole	559

V

VAP 40	562
VAP 70	562
VAP 100	562
VAP SLIM 30 Pole, E27	565
VAP SLIM 60 Pole, E27	565
VAP SLIM 90 Pole, E27	565
VARU EL, QPAR51.....	404, 711
VERLUX EL, quadratisch, PHASE.....	393
VILUA S WL	643
VILUA L WL	643
VILUA UP/DOWN, WL.....	643

W

WALLYX WL, QPAR51	647
WL 106 E14.....	237
WL 149 WL, PHASE	205
WL 149 WL, QT-DE12.....	205
WORKLIGHT FL.....	101
WORKLIGHT PD, DALI.....	146
WORKLIGHT TL.....	100
WORO EL.....	413

Z

ZUBEHÖR

1-10V Dimmer 10W	792
DALI CONTROLLER 24V DC.....	794
DALI INTERFACE 1-10V + on/off.....	777, 794
DALI UNIVERSAL DIMMER 10-300W ..	777, 794

DALI UNIVERSAL DIMMER 3-25W	777, 794	SLV VALETO® Fernbedienung,	
Deckenhaken.....	803	CCT/RGBW	783
Doppelseitiges Klebeband	804	SLV VALETO® Gateway	782
Drahtseilabhangung	803	SLV VALETO® Wandeinbau Dimmer.....	783
GLENOS® Deckenrossette	803	Steckerleiste 3 Ausgange	804
GU10 Fassung.....	804	Stopper fur Drahtseil	804
GU10 Fassung mit Anschlussbox		Textilkabel 10m	803
und Schnellklemme	804	T-Verbinderbox 3-polig	805
LED Netzteil 60W DALI, 24V, 2 Kanal	797	Transformator 12V AC 10VA IP44	792
LED Netzteil	797	Transformator 12V AC 150VA	792
LED Netzteil 100W DALI, 24V, 2 Kanal....	797	Transformator 12V AC 60VA	792
LED Netzteil 12V 100W		Transformator 12V AC 60VA IP44	792
inkl. Zugentlastung.....	797	Transformator TENSEO 12V AC 105VA ...	793
LED Netzteil 12V 12W		Transformator TENSEO 12V AC 210VA ...	793
mit Zugentlastung	795	Transformator TENSEO 12V AC 50VA	793
LED Netzteil 12V 15W	795	Verbindungsbox 5-polig	805
LED Netzteil 24V 12W		Verbindungsbox IP68, 3-polig	805
mit Zugentlastung	795		
LED Netzteil 24V 15W	795		
LED Netzteil 24V 20W	795		
LED Netzteil 24V 40W	795		
LED Netzteil 24V 50W			
inkl. Zugentlastung	796		
LED Netzteil 24V 60W	796		
LED Netzteil 24V DC 100W			
inkl. Zugentlastung.....	796		
LED Netzteil 24V DC 150W	796		
LED Netzteil 24V DC 150W			
inkl. Zugentlastung	796		
LED Treiber 1000mA 39W			
inkl. Zugentlastung.....	799		
LED Treiber 1000mA 40W	799		
LED Treiber 1000mA 60W			
inkl. Zugentlastung.....	802		
LED Treiber 1050mA 30W			
inkl. Zugentlastung.....	799		
LED Treiber 200mA 10W			
inkl. Zugentlastung.....	800		
LED Treiber 200mA 6-8,4W			
inkl. Zugentlastung.....	797		
LED Treiber 250-700mA 20W			
inkl. Zugentlastung	800		
LED Treiber 250-700mA 40W			
inkl. Zugentlastung	800		
LED Treiber 250mA 10 W	800		
LED Treiber 320mA 3W			
inkl. Zugentlastung	800		
LED Treiber 350mA 10W	798		
LED TREIBER 350mA 15W	798		
LED Treiber 350mA 15W			
inkl. Zugentlastung	801		
LED Treiber 350mA 20W	798		
LED Treiber 350mA 20W			
inkl. Zugentlastung	801		
LED TREIBER 350mA 3W	797		
LED Treiber 350mA 3W			
inkl. Zugentlastung.....	801		
LED Treiber 500/600/700mA 30W			
inkl. Zugentlastung.....	801		
LED Treiber 500mA 10W			
inkl. Zugentlastung	801		
LED Treiber 500mA 15W	798		
LED Treiber 700-1500mA 50W			
inkl. Zugentlastung.....	800		
LED Treiber 700/90/100mA 40W			
inkl. Zugentlastung	802		
LED Treiber 700mA 10W	798		
LED Treiber 700mA 20W dimmbar			
inkl. Zugentlastung.....	799		
LED Treiber 700mA 39W			
inkl. Zugentlastung.....	799		
LED Treiber 700mA 3W			
inkl. Zugentlastung	801		
LED Treiber 700mA 40W	799		
LED TREIBER 700mA 6W	798		
LED Treiber 800/900/1050mA 40W			
inkl. Zugentlastung.....	802		
LED TREIBER DALI	797		
Kabelklemme	803		
Kabelverlangerung	804		
Kompensationsmodul	794		

REFERENZPROJEKTE MIT **LICHTLÖSUNGEN** VON SLV

Lernen Sie viele weitere Anwendungsmöglichkeiten der SLV Produkte an realen Projekten kennen. GOOD LIGHT References liefert Ihnen eine Übersicht vielfältiger Beleuchtungskonzepte von und für unsere Kunden.

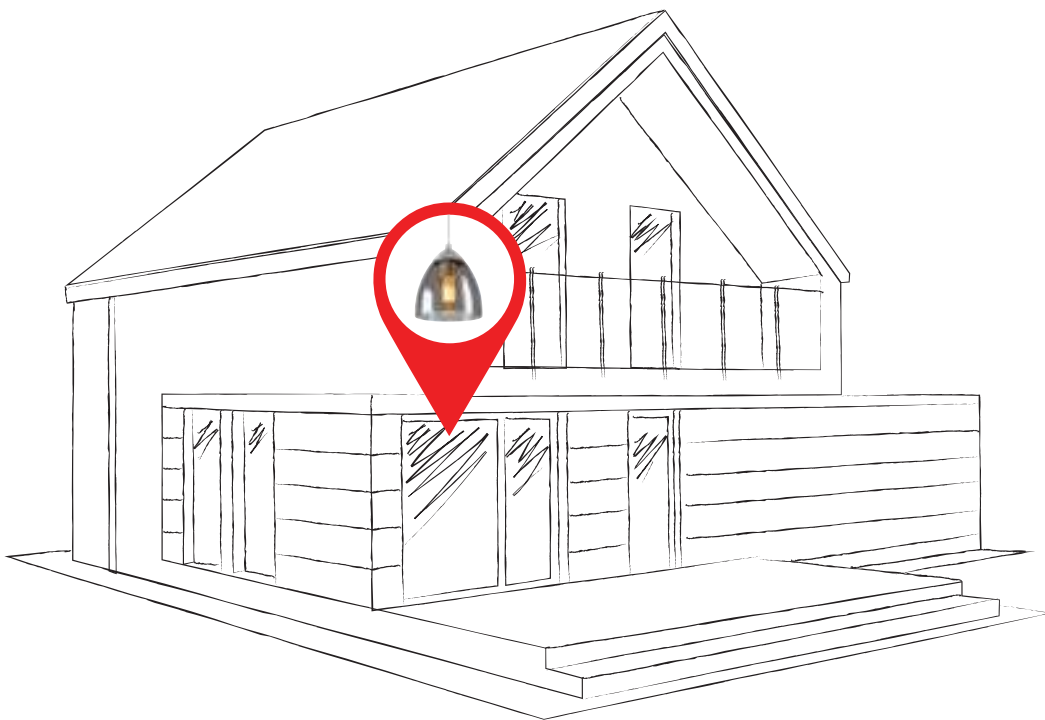



Vom Einfamilienhaus mit Garten, über DALI-steuerbare Shop-Beleuchtung, bis hin zu Großprojekten wie Hotelanlagen und Bürokomplexen – mit SLV haben Sie einen starken Partner für alle Anwendungsbereiche an Ihrer Seite.

Überzeugen Sie sich selbst und lassen sich von bereits umgesetzten Projekten inspirieren.

JETZT QR-CODE SCANNEN >>>



Mehr Inspiration und Referenzen finden Sie auf
www.slv.com



„Raum und Licht und Ordnung.

Das sind die Dinge, die man genauso braucht
wie Brot oder einen Platz zum Schlafen.“

Le Corbusier

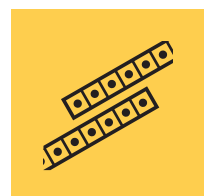
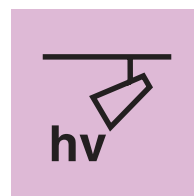
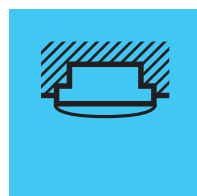

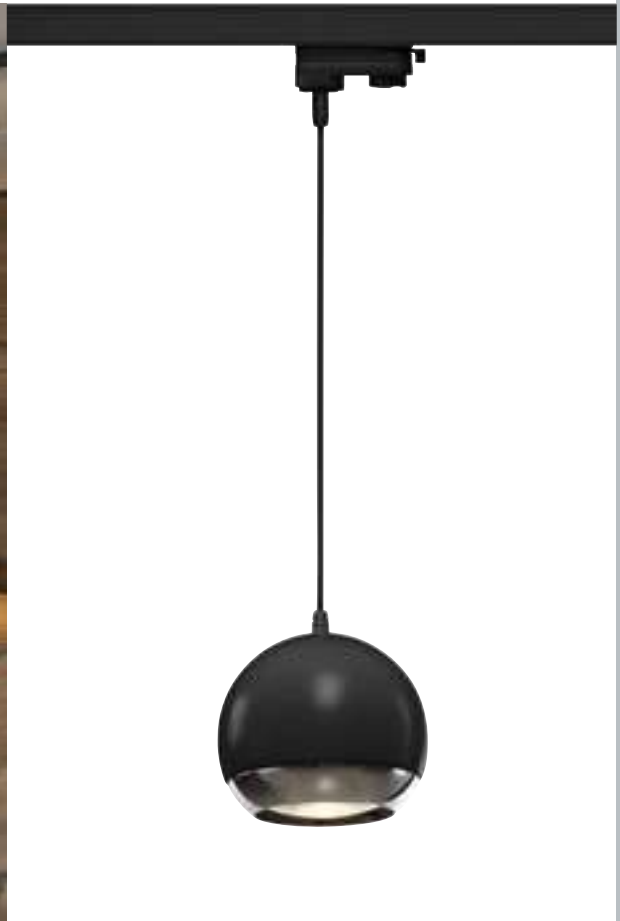

„Design is the appropriate combination of materials in order to solve a problem.“

Charles Eames, Designer





„Inspiration exists,
but you have
to find it working.“

Pablo Picasso

„Licht schafft Atmosphäre und
das Gefühl des Raums
sowie den Ausdruck einer Struktur.“

Le Corbusier

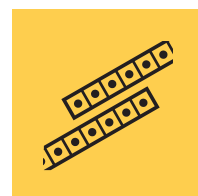
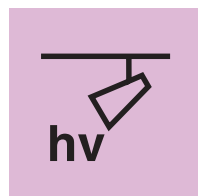
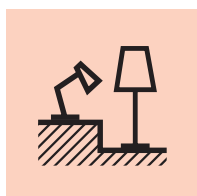



„The details are
not the details.
They make the design.“

Charles Eames, Designer



Sie haben Ihr Projekt mit SLV Leuchten erfolgreich umgesetzt?
Erzählen Sie uns davon! Gerne mitsamt Fotos und ausführlichen
Hintergrundinfos: references@slv.de



SLV WELTWEIT.

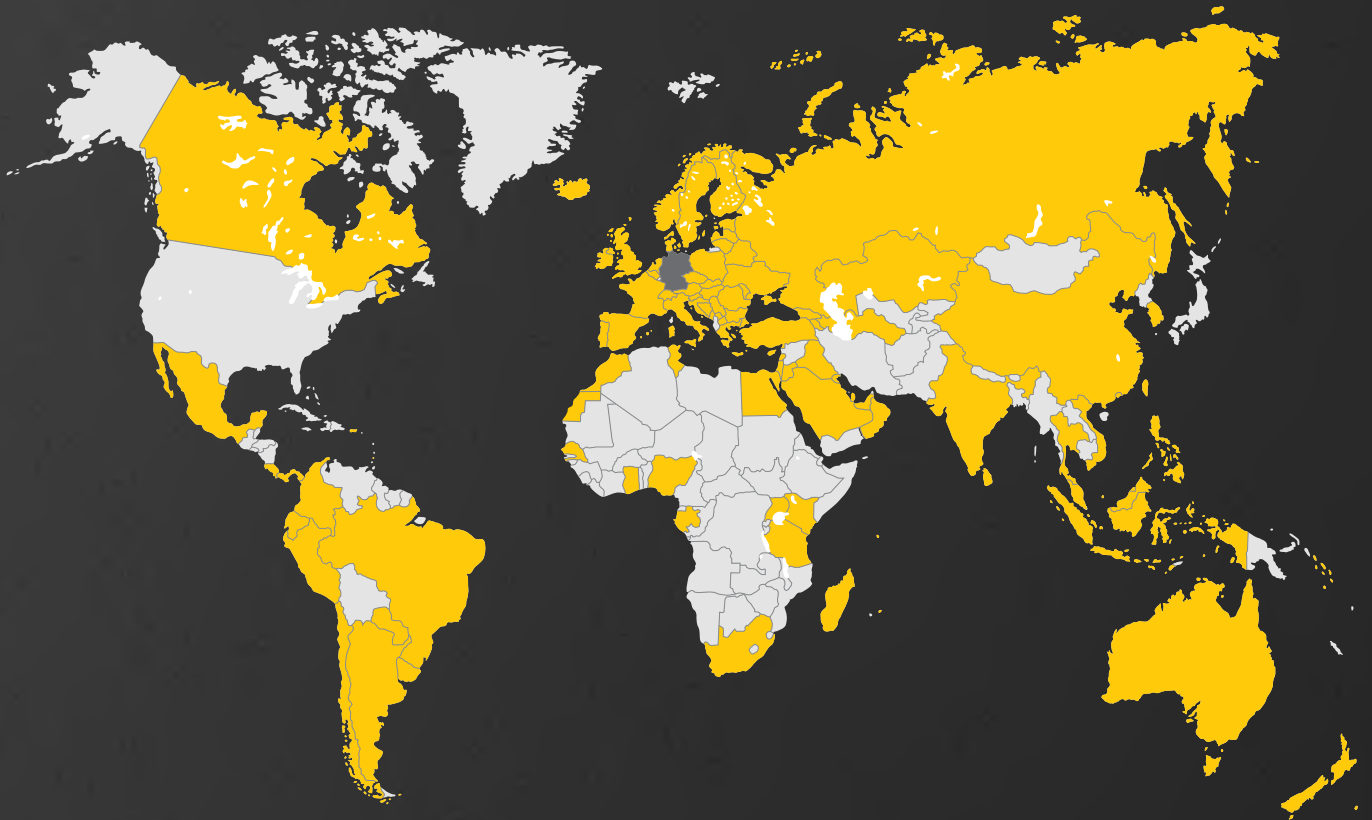

ÜBER **100** LÄNDER – EINE GEMEINSAME SPRACHE: **EXPERIENCE LIGHT.**

Unsere SLV Leuchten bringen **rund um den Globus** Licht ins Dunkel.
Bereits jetzt sind unsere Leuchten in über 100 Ländern im Einsatz.

Und die Reise geht weiter, denn gemeinsam mit Ihnen wollen wir
Menschen **weltweit** für das Erlebnis Licht begeistern.

SYMBOLERKLÄRUNG

PRODUKTEIGENSCHAFTEN



Energieeffizienzklasse

„Diese Leuchte ist geeignet für Leuchtmittel der Energieeffizienzklassen ...“



Leuchten mit eingebauten LEDs

„Diese Leuchte enthält eingebaute LED-Lampen. Die Lampen können in der Leuchte nicht ausgetauscht werden.“ (s. EU-Verordnung 874/2012)



„Diese Leuchte enthält eingebaute LED-Lampen. Die Lampen können in der Leuchte nicht ausgetauscht werden.“ (s. EU-Verordnung 874/2012)

Hinweis für den Endnutzer:

Die Lichtquelle dieser Leuchte darf nur vom Hersteller oder einem von ihm beauftragten Servicetechniker ersetzt werden.



Dimmbar mit ...

- C = Phasenabschnittsdimmer
- L = Phasenabschnittsdimmer



- Uni = Universaldimmer
- 1-10 V
- Dali = Dali Bussystem



- Switch = Schalter/Taster bzw. Touch Control an der Leuchte



Dim to warm

Beim Dimmern verändert sich die Lichtfarbe von kaltweiß zu warmweiß.

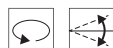

Dreh- und Schwenkbarkeit in Grad:

- Drehbereich
- Schwenkbereich
- Kardanisch



Der Halbstreuwinkel

Beschreibt den Ausstrahlungswinkel in Grad. Je kleiner der Winkel desto stärker wird das Licht gebündelt.



Pendelkabellänge in cm

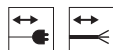

Netzkabellänge in cm

Zuleitungslänge in cm (bei offenem Kabelende)



Mittlere Lebensdauer eines Leuchtmittels bzw. einer Lichtquelle in Stunden



Der Lichtstromerhalt

Beschreibt um wie viel der Lichtstrom einer LED im angegebenen Zeitraum abnimmt.



Kennzeichnet mit **Fernbedienung** steuerbare Produkte



UGR = Unified Glare Rating

Je niedriger der UGR-Wert, desto geringer die psychologische Blendung.

SICHERHEITSTECHNISCHE ANGABEN



Schutzklassen

- Schutzklasse I / Schutzleiter
- Schutzklasse II / Schutz durch doppelte oder verstärkte Isolierung
- Schutzklasse III / Schutz durch Kleinspannung



Der IK-Stoßfestigkeitsgrad ist ein Maß für die Widerstandsfähigkeit von Gehäusen elektrischer Betriebsmittel gegen mechanische Beanspruchung, insbesondere Stoßbeanspruchung.

SPEZIFISCHE ANGABEN – EINBAULEUCHTEN



Form der Einbauöffnung



Angabe der **Einbautiefe**



Überfahrbarkeit des Produktes gegeben



Gewichtsbelastbarkeit des Produkts bis zum angegebenen Wert in Tonnen. Messungen basieren auf Betoneinbau.

EINSATZBEREICH · MONTAGE



IP-Schutzart

Gibt die Eignung elektrischer Betriebsmittel für verschiedene Umgebungsbedingungen an.



Erlaubt die Montage eines elektrischen Betriebsgeräts auf Werkstoffen, deren **Entflammverhalten** nicht bekannt ist.



Durchverdrahtung möglich



Unabhängiger Konverter

(Betriebsgerät auch zur Verwendung außerhalb von Leuchten)



Kurzschlussfestes **Sicherheitsbetriebsgerät**



- Einsatz **ausschließlich** für Innenräume
- **Ungeeignet** für die Anwendung in Innenräumen

BESONDERE SYMBOLE



Kennzeichnet **erstmalig** in den Katalog aufgenommene Produkte



Kennzeichnet **neue Varianten** bestehender Produkte



- Neue Produktvariante
- Nachfolger



Artikel mit diesem Zeichen sind **Auslaufmodelle**



Kennzeichnet Produkte

- mit **eingebauten LEDs**
- mit **Lampenfassung**



Connected Lighting

Kennzeichnet smarte Produkte, die folgende Protokolle verwenden:

- Zigbee® · DALI · Bluetooth



Kennzeichnet **Leuchten mit Bewegungsmelder** (Mikrowellen (MR)-Technik / Infrarot / Funk)



Mittels eingebautem **CCT** Schalter kann die **Lichtfarbe** bei der Installation von 3000K auf 4000K gewechselt werden.



Kennzeichnet **Leuchten mit RGB+W** und **RGB** (Rot-Grün-Blau + Weiß und Rot-Grün-Blau)



- **USB-Ladefunktion**
- **Induktive (kabellose) Ladefunktion** für Smartphones



Kennzeichnet **individuell kombinierbare** Produkte



Kennzeichnet Leuchten, die nach Grundierung **individuell mit Wandfarbe überstreichbar/tapezierbar** sind.



Kennzeichnet Leuchten aus einer **Leuchtenfamilie**



Prämierte Leuchten

- Red Dot Design Award
- German Design Award

KUNDENINFORMATIONEN

Hinweise zur Hitzeentwicklung am Leuchtgehäuse

Halogenleuchtmittel haben eine hohe Betriebstemperatur und können zur Aufheizung des jeweiligen Leuchtgehäuses führen. Letzteres darf daher nur im abgekühlten Zustand berührt werden. Verstellbare Leuchten bzw. Leuchtenköpfe, die nicht über isolierte Verstellgriffe verfügen oder die bei Betrieb mit der maximalen Leuchtmittelleistung die maximal zulässige Gehäusetemperatur an der offensichtlichen Verstellstelle übersteigen, sind zudem außerhalb des Handbereichs zu montieren. Als Niedrigtemperatur-Alternative sind zu den meisten unserer Halogenleuchten LED-Retrofit-Leuchtmittel erhältlich.

Lichtstrom

Die Gesamtlichtmenge, die von einer Lichtquelle erzeugt wird, wird in Lumen (lm) angegeben.

Lichtstärke

Die Lichtstärke ist der pro Raumwinkel angegebene Lichtstrom und wird in Candela (cd) angegeben.

Farbwiedergabeindex

Die Farbwiedergabeeigenschaft einer Lichtquelle wird mit dem Ra Index (englisch Color Rendering Index) beschrieben. Bei in Innenräumen eingesetzten Lichtquellen ist ein CRI von 80 oder höher vorgeschrieben. Lichtquellen für den Außenbereich müssen einen CRI von mindestens 65 aufweisen.

Lichtfarbe

Die Lichtfarbe einer Lichtquelle wird in K (Kelvin) angegeben.

Standard-LED

Dies ist die klassische Ausführung der LED (3 mm oder 5 mm LED). Diese wurden ursprünglich für Indikationszwecke, z. B. in Instrumententafeln, entwickelt.

Standard SMD LED

SMD bedeutet „Surface Mounted Device“ (oberflächenmontierbares Bauteil). Sie ist eine kompakte LED, die ohne Drahtanschlüsse direkt auf die Leiterplatte aufgelötet wird. Die SMD ist in verschiedenen Größen erhältlich und eignet sich hervorragend für Beleuchtungszwecke.

PowerLED

PowerLED ist eine leistungsstarke LED mit einer Leistung von 1W und mehr. Sie stellt erhöhte Anforderungen an die Stromkonstanz und sollte daher grundsätzlich mit Konstantstromquellen betrieben werden. Sofern mehrere Leuchtdioden angeschlossen werden sollen, müssen diese daher in Reihe geschaltet werden. Eine Parallelschaltung ist unzulässig. Bitte beachten Sie zudem die Installationsreihenfolge, um die LEDs nicht kurzzeitig zu hohem Strom auszusetzen und sie damit zu beschädigen. Grundsätzlich gilt: Erst den Sekundärstromkreis (LEDs an Treiber) vollständig anschließen, danach den Primärstromkreis (Treiber an Stromquelle) schließen.

Chip On Board LED (COB LED); Flächen-LED

Hier handelt es sich um eine LED in extrem flacher Bauform. Vorteil der COB LED ist eine gute Wärmeableitung bei technischer Umsetzung mit Kühlflächen, wodurch eine hohe Lichtausbeute und eine hohe Lebensdauer möglich sind.

Edelstahl 304

(1.4301) Eine gute Korrosionsbeständigkeit zeigt sich in natürlichen Umweltmedien (Wasser, städtische und ländliche Atmosphäre) bei Abwesenheit von bedeutenden Chlor- und Salzkonzentrationen. 1.4301 ist jedoch weder für Einsatzgebiete, in denen es zum Kontakt mit Meer- bzw. Salzwasser oder salzhaltiger Atmosphäre kommt, noch für den Einsatz in Schwimmbädern oder ähnlichem geeignet.

Edelstahl 316

(1.4404) In natürlichen Umweltmedien (Wasser, städtische und ländliche Atmosphäre) sowie in Industriegebieten mit mäßiger Chlor- und Salzkonzentration, im Bereich der Lebensmittel- und Pharmaindustrie und auf dem landwirtschaftlichen Nahrungsmittelsektor weist 1.4404 eine ausgezeichnete Korrosionsbeständigkeit auf. 1.4404 ist nicht meerwasserbeständig.



Bitte beachten Sie:

Ein großer Teil der in diesem Katalog vorgestellten Produkte ist durch Warenzeichen, Geschmacksmuster, Gebrauchsmuster oder Patente geschützt. Ein Verstoß gegen diese Schutzrechte oder eine Verwendung von Text- und Layoutgestaltung sowie urheberrechtlich geschützten Bildern ohne unsere Genehmigung wird gerichtlich verfolgt. Die in diesem Katalog enthaltenen Abbildungen und Angaben dienen nur der Veranschaulichung und sind unverbindlich in Farbe, Form, Ausführung und technischen Daten. Bei sämtlichen Produktbeschreibungen/-angaben bleiben Änderungen und Irrtümer daher vorbehalten.

Alle Produkte unseres Sortiments unterliegen einer strengen Qualitätssicherung und erfüllen die allgemein gültigen Normen. Dieser Katalog beinhaltet ein allgemeines Sortiment und ist nicht landesspezifisch ausgelegt. Etwaige Abweichungen von landesspezifischen Vorgaben sind vor der Bestellung zu klären. SLV haftet nicht für gegebenenfalls abweichende technische Normen.

Alle Gewichts- und Längenangaben sind in kg bzw. in cm angegeben, sofern nicht anders bezeichnet. Technische Änderungen vorbehalten!

Die Präsentation unserer Leuchten mit realistischen und beispielhaften Anwendungsfotos wird ermöglicht durch das freundliche Entgegenkommen und die Zustimmung der Eigentümer oder Gestalter der jeweils vordergründig in den Bildern zu sehenden Umgebungen. All jenen, die durch ihr Einverständnis zur Entstehung und Verwendung unserer Fotos beigetragen haben, sei an dieser Stelle nochmals herzlich gedankt!

Mit Erscheinen dieses Katalogs sind die Preise in den bisher erschienenen Listen und Katalogen ungültig. SLV ist berechtigt, die jeweilige Preisliste an sich verändernde Marktbedingungen, bei erheblichen Veränderungen in den Beschaffungskosten, Änderungen der Umsatzsteuer oder der Beschaffungspreise, anzupassen.

Alle Preisangaben verstehen sich als unverbindliche Preisempfehlung (UVP) in Euro ohne MwSt.

Herausgeber

SLV GmbH, Deutschland
Daimlerstraße 21-23
52531 Übach-Palenberg
T +49 (0) 2451 4833-0
slv.com

Copyright

© SLV GmbH, 2021

Bildnachweise

SLV GmbH
Externe Fotografen: Andreas Fein, Anja Lynen, Gerd Arnolds, Günther Preissler, Marc Derkum, Dirk Hoffmann

Qualitätsbündnis für die Elektrohandwerke

Die Premium E-Marken-Partnerschaft ist eine branchenweite Qualitäts-Marke der Elektrohandwerke im Zentralverband der Deutschen Elektro- und Informationstechnischen Handwerke (ZVEH). Dieser Qualitätsgemeinschaft gehört SLV an. Sie steht für Qualität in den Produkten und in der Ausführung.



EXPERIENCE LIGHT

SLV GmbH

Daimlerstraße 21-23
52531 Übach-Palenberg
Deutschland

T +49 (0) 2451 4833 - 333

F +49 (0) 2451 4188 - 8

info@slv.de

slv.com



Beim Druck dieses Produkts wurde durch den innovativen Einsatz der Kraft-Wärme-Kopplung im Vergleich zum herkömmlichen Energieeinsatz bis zu 52% weniger CO₂ emittiert.